

SAMSUNG



37X/33X/27X Ultra-Low Light SPEED DOME CAMERA SPD-3700T/3700/3310/2700 User's Manual

Before installing and operating the camera, please read this user's manual carefully.

English

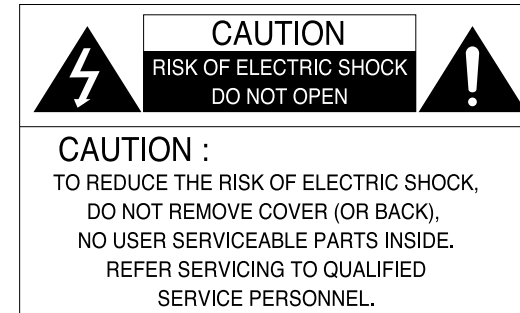

The lightning flash with an arrowhead symbol, within an equilateral triangle is intended to alert the user to the presence of uninsulated “dangerous voltage” within the product's enclosure that may be of sufficient magnitude to constitute a risk of electric shock to persons.



The exclamation point within an equilateral triangle is intended to alert the user to the presence of important operating and maintenance (servicing) instructions in the literature accompanying the appliance.

INFORMATION-This equipment has been tested and found to comply with limits for a Class A digital device, pursuant to part 15 of the FCC Rules. These limits are designed to provide reasonable protection against harmful interference when the equipment is operated in a commercial environment. This equipment generates, uses, and can radiate radio frequency energy and, if not installed and used in accordance with the instruction manual, may cause harmful interference to radio communications.

Operation of this equipment in a residential area is likely to cause harmful interference in which case the user will be required to correct the interference at his own expense.

WARNING

- CHANGES OR MODIFICATIONS NOT EXPRESSLY APPROVED BY THE MANUFACTURER COULD VOID THE USER'S AUTHORITY TO OPERATE THE EQUIPMENT.
- TO REDUCE THE RISK OF FIRE OR ELECTRIC SHOCK, DO NOT EXPOSE THIS PRODUCT TO RAIN OR MOISTURE.

CAUTION : To prevent electric shock and risk of fire hazards:

- The installation for this apparatus should be by a qualified service person and should conform to all local codes.
- Do NOT use power sources other than Class 2 power source.
- Carefully push the unlock buttons to prevent injury due to falling of this apparatus.

This installation should be made by a qualified service person and should conform to all local codes.

Contents

| | | | |
|---|----|--|--|
| • Features | 6 | | |
| • Cautions for Using Auto Track (SPD-3700T) | 7 | | |
| • Warnings & Cautions | 9 | | |
| • Components and Accessories | 12 | | |
| • Component Names and Functions | 13 | | |
| • Installing Your Camera | 15 | | |
| ■ Speed Dome Camera and Appliances Wiring Diagram | 15 | | |
| ■ Communication DIP Switch Settings (SW2) | 17 | | |
| ▶ Protocol Settings | 17 | | |
| ▶ Baud Rate Settings | 18 | | |
| ▶ Communication Method Settings | 18 | | |
| ▶ Communication Response Settings | 18 | | |
| ▶ Termination Settings | 18 | | |
| ▶ Camera Backup Settings | 19 | | |
| ■ Camera ID DIP Switch Settings (SW1) | 19 | | |
| ▶ Camera ID Chart | 20 | | |
| ■ On-Ceiling Mount Type Installation Example | 29 | | |
| • Interface Symbols | 32 | | |
| • Operating Your Camera | 33 | | |
| • Functional Description | 37 | | |
| ■ Camera Setting | 37 | | |
| ▶ Focus and Zoom | 37 | | |
| ▶ White Balance | 39 | | |
| ▶ Exposure | 40 | | |
| ▶ Backlight | 41 | | |
| ▶ AGC | 44 | | |
| ▶ SSNR(Samsung Super Noise Reduction) | 45 | | |
| ▶ Day & Night | 46 | | |
| ▶ Others | 47 | | |
| ■ Sequence Setting | 48 | | |
| ▶ Power On Resume & MD Dwell Time | 48 | | |
| ▶ Preset | 49 | | |
| ▶ Swing SEQ | 53 | | |
| ▶ Group SEQ | 54 | | |
| ▶ Tour SEQ | 55 | | |
| ▶ PTZ Trace | 56 | | |
| ▶ Auto Run | 57 | | |
| ■ P/T Setting | 58 | | |
| ▶ Pan/Tilt Limit | 58 | | |
| ▶ Area Setting | 59 | | |
| ▶ Area Masking | 60 | | |
| ▶ Prop. P/T | 61 | | |
| ▶ Digital Flip | 62 | | |
| ▶ Image Hold | 63 | | |
| ▶ Auto Track1 | 64 | | |
| ▶ Auto Track2 | 66 | | |
| • OSD Setting | 68 | | |
| • Alarm Setting | 69 | | |
| • Initialization Setting | 73 | | |
| • Status Check | 75 | | |
| • Product Specifications | 76 | | |

A/F 37x/33x/27x Optical Zoom

The built-in 37x (SPD-3700T/37-0)/33x (SPD-3310)/27x (SPD-2700) optical zoom lens with auto-focus is combined with a 12x digital zoom, providing a maximum of 444x/396x/324x zoom.

Versatile Protocol Processing

This camera supports a total of 8 types of communication protocols: Samsung Techwin, Pelco-D, Pelco-P, Samsung Electronics, Panasonic, Honeywell, AD and Vicon.

Wide Range Auto Security Functions

- Auto Tracking (SPD-3700T Only) : A moving object or a person can be tracked and recorded automatically by the camera with its Pan, Tilt, and Zoom functions.
- Multiple Preset Function Saving : Up to 13 camera image properties can be saved individually to provide high quality pictures.
- Image Holding : When moving between presets in Group and Tour functions, using this Preset Freeze function holds the image status and helps the screen observer relieve visual fatigue.
- PIZ Trace : Patterns operated with the joystick can be saved and replayed by users.
- Swing : Using the Swing function commands the camera to move between 2 selected locations, monitoring the route.
- Group Search : Maximum 255 Preset positions are toured in order.
- Tour Search : Maximum 6 Group Search functions are toured in order.

Digital Flip

The Digital Flip function is useful to monitor moving objects or people passing directly under the camera. When an object or a person passes directly under the camera, its tilt monitor follows the object or person over 100 degrees to the other side of the tilt area without panning. The screen inversion starting to occur at 100 degrees or higher is digitally adjusted.

Smart P/T

The Smart P/T function automatically adjusts the control speed of the Pan and Tilt functions according to the current zoom power. It is useful to adjust the functions manually for detailed controls when monitoring a high-powered zoom.

Day & Night

With its daytime & nighttime switch and Sens-Up functions based on the ICR (Infrared Cut filter Removal) method, the camera provides high quality pictures regardless of whether it is day or night.

* Sens-Up increases the CCD sensitivity by electrically extending the camera's exposure time.

* Day & Night enables you to select between color and B/W modes depending on the lighting conditions.

OSD (On Screen Display)

The camera IDs, camera preset numbers, preset names, area names, and camera operation status are displayed on the monitor, allowing set up of various camera functions through the OSD menu screen.

Preset Position Saving and Loading

Up to 255 preset positions can be set. Using this function saves and brings up the camera feed of a selected monitoring location.

Camera Backup

This is to back up the camera's sequence information and presets. This is useful when the camera or its install base are damaged or malfunctions occur.

Area Masking

If a monitoring location includes a highly private area, the area can be selectively masked on the screen.

The following cautions are for the Auto Track function built-in with the SPD-3700T; The SPD-3700/3310/2700 do not have Auto Track.

To use Auto Track to its full potential, please read and be aware of the following cautions. Neglecting the cautions may cause unsatisfactory performance of the tracking function as well as camera malfunctions.

- Auto Track is specifically to track down unknown intruders. It is not suitable to monitor a crowd.
- If the camera is not safely secured, tracking errors may occur.
- If the camera lens is smeared with foreign substances, snow flakes, or raindrops, the camera may incur unsatisfactory performance in the tracking function. For optimal performance, please install the camera in an environment safe from contamination, and clean the camera lens on regular basis.
- If the tracking function shows poor performance at nighttime or under low light circumstances, use the Sens-Up function.
- Auto Track may have errors at times when pronounced shadows are created: e.g. sunrise and sunset.
- The camera may catch and follow unintended movements – car traffic or swaying tree branches – during the Auto Track operation. To prevent and correct such errors, adjust the installation direction and angle of the camera, or use Zone Settings (Mask) (page 67).
- Adjust the installation direction and angle of the camera, or use Zone Settings also under the following conditions: With excessively bright light sources, under flickering lights, or if the camera displays internal reflections.
- When using Auto Track, it is recommended to adjust the tracking object size to 1/4 of the screen.
- This feature may not perform as expected depending on the situation and circumstances. Samsung Techwin is not responsible for injuries and financial damage caused by the situation described above.



Samsung Techwin cares for the environment at all product manufacturing stages to preserve the environment, and is taking a number of steps to provide customers with more environment-friendly products. The Eco mark represents Samsung Techwin's will to create environment-friendly products, and indicates that the product satisfies the EU RoHS Directive.

Warnings & Cautions

This information is provided to ensure your safety and to prevent any losses, financial or otherwise. Please read it carefully and use the product accordingly.

- * For product inquiries, please contact the retail shop where you bought the camera. The use of equipment such as an aerial ladder while providing after-sales service shall be at your expense.
- * Unplug the power plug when thunder crashes or lightning flashes to prevent fire and damage to the product.
- * This product is support equipment for a security system. Therefore, we can't compensate for material losses and/or personal injuries by robbery, fire, natural disaster, or anything of the sort.

Warning/Caution/Special Mark Messages

| | | | |
|---|--|---|---|
|  | Ignoring this information may result in material loss and/or serious personal injuries, including death. |  | Ignoring this information may result in material loss and/or slight injuries. |
|  | Indicates "Prohibited". |  | Indicates "No Disassembly". |



Correct Disposal of This Product (Waste Electrical & Electronic Equipment)

(Applicable in the European Union and other European countries with separate collection systems)

This marking shown on the product or its literature, indicates that it should not be disposed with other household wastes at the end of its working life. To prevent possible harm to the environment or human health from uncontrolled waste disposal, please separate this from other types of wastes and recycle it responsibly to promote the sustainable reuse of material resources.

Household users should contact either the retailer where they purchased this product, or their local government office, for details of where and how they can take this item for environmentally safe recycling.

Business users should contact their supplier and check the terms and conditions of the purchase contract. This product should not be mixed with other commercial wastes for disposal.

Warnings & Cautions

Warnings

Do not install on your own.

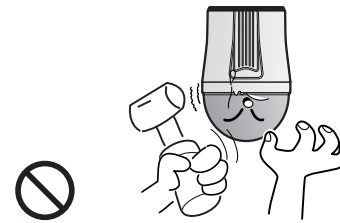

This installation should be made by a qualified service person. Installing this product on your own may result in fire or electric shock. For the installation service, contact the retail shop where you bought the product.

Stop using the camera if smoke or abnormal heat is detected.

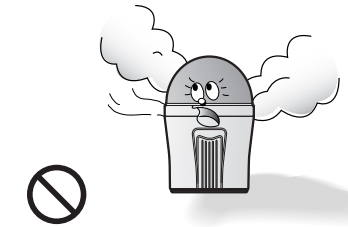

May cause fire.

Do not install in high humidity or in a place that may be exposed to oil or gas.

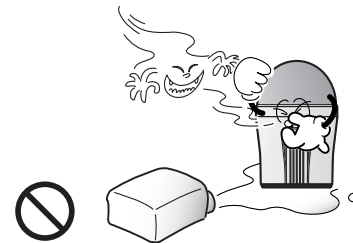

May cause product malfunctions, electric shocks, and fire.

Do not install on an unsubstantial wall that may be subject to vibrations.

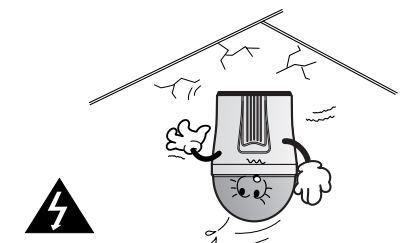

May cause the product to fall.

Do not handle the power plug with wet hands.

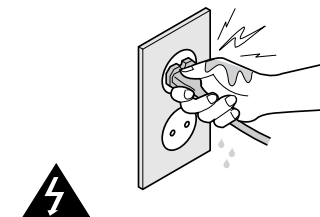

May cause electric shock.

Do not disassemble the camera or insert foreign subjects.

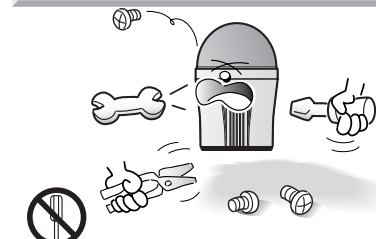

May cause fire and damage to the product.

Warnings & Cautions

▲ Cautions

Do not install under extreme temperature conditions.

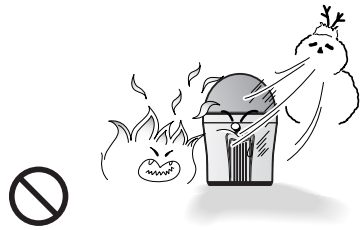

Use only under temperature conditions between -0°C and $+50^{\circ}\text{C}$ to prevent low graphics quality and product malfunctions. When using in high temperature conditions, provide good ventilation.

Do not install under unstable lighting conditions.

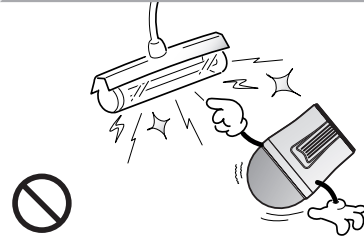

Severe lighting changes or flickering may hinder normal camera operation.

Do not drop the camera or subject it to physical shock.

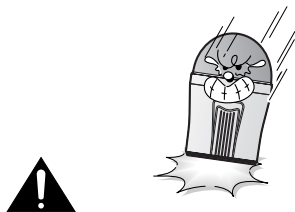

May cause product malfunctions.

Never keep the camera face to direct sunlight or any other strong lights.

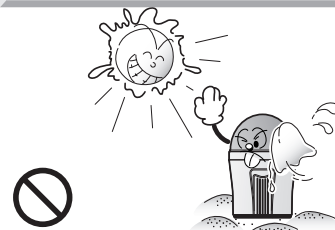

May cause critical damage to the CCD.

Avoid touching the camera lens.



The lens is the most important component of the camera. Be careful not to smear it with fingerprints.

Do not install in a place that may be exposed to rain, water, or radioactivity.



Water leakage into the camera may cause damage.

Warnings & Cautions

Detailed Warnings and Cautions

- Avoid operating the camera for long durations under high temperatures and in high humidity. Excessive heat can shorten the lifespan of the camera components.
- Do not install or place the camera near any heat sources.
- Subjecting the dome cover to physical shock may damage the camera and cause water leakage into it.
- Do not place the camera facing direct sunlight or other intense light sources. Strong lights such as spotlights can cause distortions—blooming and smear—as well as discolorations on the screen by heating up the color filter of the camera. They also may cause internal reflections of the camera, leading to operational malfunctions.
- Do not drop the camera or subject it to physical shock or vibration; this can cause serious damage to the camera.
- When installing the camera near a power line, make sure to keep at least 1 meter distance from the power line, or earth an additional metal pipe to separate the camera from the power source.
- This camera is to install on the ceiling. Installing it on the ground or a unlevelled location may cause product malfunctions and shorten its lifespan.
- This camera is provided with separate indoor and outdoor housings. When installing it in an outdoor environment, use the outdoor housing.
- Avoid installing and operating the camera in the following places.
 - Places whose temperature exceed the camera's recommended range. (Indoor: -10°C ~ 50°C , Outdoor: Refer to the housing manual)
 - Places where drastic temperature changes occur: e.g. Near an air conditioner.
 - Places that are exposed to steam, oil, and inflammable substances: e.g. Inside a kitchen.
 - Places that are exposed to radioactivity, X-rays, strong electric waves, and electromagnetic waves.
 - Places that are exposed to outdoor air contaminants: e.g. Dust and car exhaust.
 - Places in high humidity.
 - Places that are exposed to corrosive gas: e.g. Next to the sea.
- Smearred and dusty dome covers decrease the picture and video quality. Clean the dome cover and camera lens on a regular basis.
- Remove the plastic wrap on the dome cover only after the camera installation is complete.
- This camera is not equipped with a power switch. Plug in the camera only after the installation is complete.

Components and Accessories

* Components

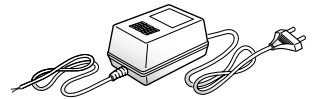

Power Adapter (AC 24V, Peak 2.5A)



User's Manual

* Accessories

The following items are sold separately from the camera.

Housings



STH-380PO
Ultra Low-Temperature
Heavy
(-40°C~50°C)



STH-370PO
Low-Temperature
Heavyweight
(-20°C~50°C)



STH-370PI
Indoor Housing
(-10°C~50°C)



STH-360PO
Low-Temperature
Lightweight
(-20°C~50°C)



STH-370PEV
Flush-Mount
Indoor Housing
(-10°C~50°C)

Brackets



STB-350PPM
Parapet Mount

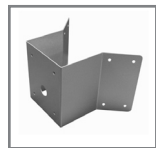

STB-340PCM
Corner Mount

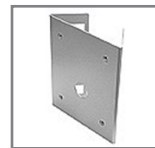

STB-330PPM
Pole Mount



STB-25PF
Indoor Flange

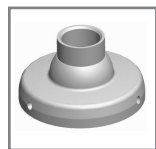

STB-30PF
Indoor Flange



STB-370PC
Surface-mount
Install Base



STB-496PPV
Ceiling Bracket



STB-270PWW
Wall Bracket



STB-270B
Setup Box

Component Names and Functions

Front

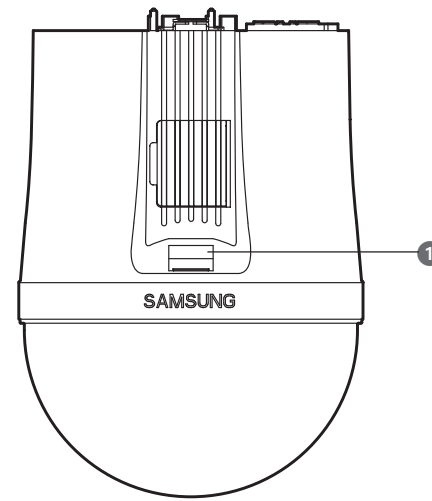

Side

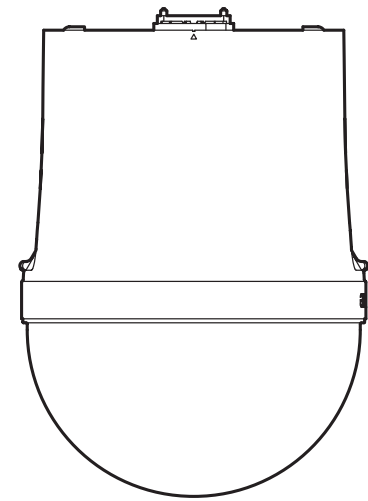

Bottom

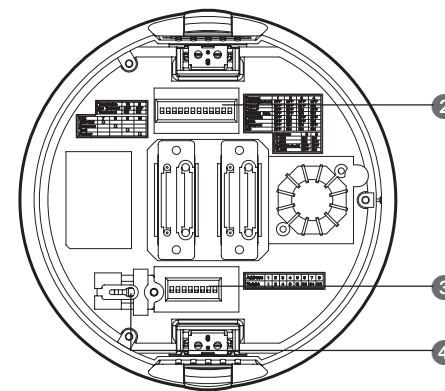

- ① Unlock Button
- ② SW2: Communication DIP Switch
- ③ SW1: ID DIP Switch
- ④ Safety Wire Holder

Notes

- For the DIP switch settings, please refer to the "Installing Your Camera" on Page 17.

Component Names and Functions

Camera Wiring Interface Board (Sold Separately)

For the camera wiring, please refer to the picture below.
The camera's wiring interface board is equipped to a housing that is sold separately.

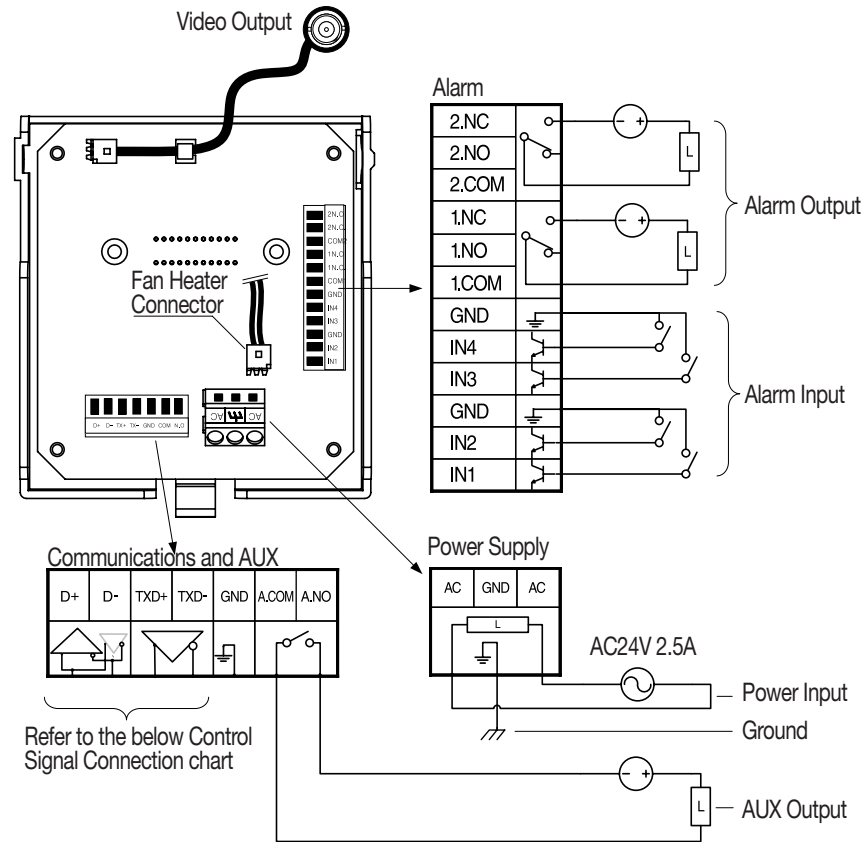

Control Signal Connection

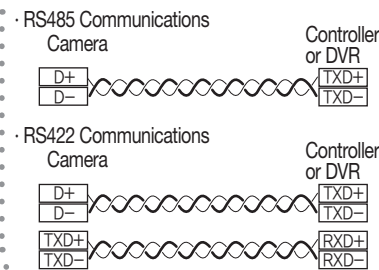

Notes

- The maximum power capacity of the built-in relay is 30VDC/2A, 125VAC/0.5A, and 250VAC/0.25A.
- Connecting the power connector and GND incorrectly to the NC/NO and COM ports may cause a short circuit and fire, damaging the camera.

Installing Your Camera

Speed Dome Camera and Appliances Wiring Diagram

Connecting with Samsung Techwin's "Stand Alone DVR"

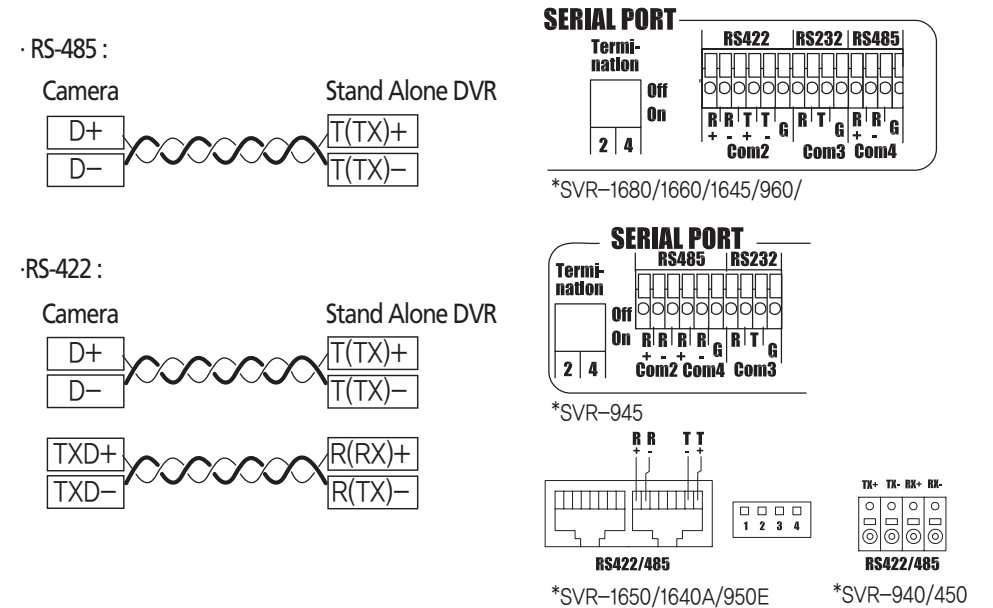

Connecting with the Samsung Techwin Controller SCC-3100A

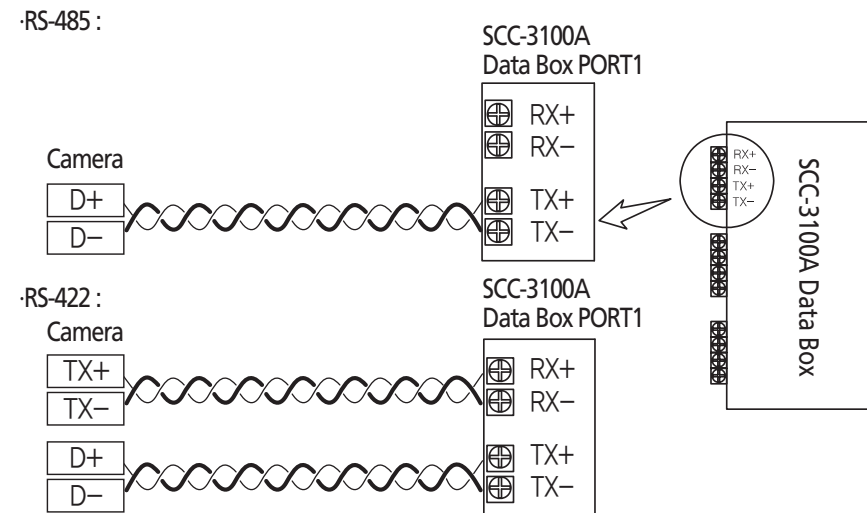

Installing Your Camera

Note!

* The following DVR models support all functions of the camera.

- 16Ch : SVR-1680/1660/1645/1650E/1640A
- 9Ch : SVR-960/945/950E
- 4Ch : SVR-440

* The following DVR models support only the Pan, Tilt, Zoom, and Focus functions of the camera.

- 9Ch : SVR-940
- 4Ch : SVR-450

* Memo

MEMO

Installing Your Camera

Communication Protocol DIP Switch Settings (SW2)

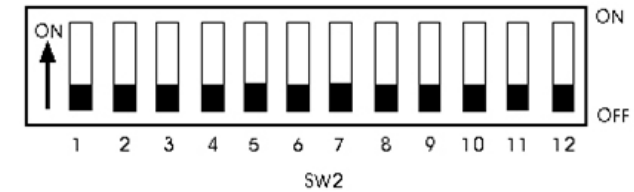

| SW2 Pin No. | Purpose |
|-------------|---------------------------------------|
| 1~4 | Protocol Settings |
| 5~6 | Baud Rate Settings |
| 7 | Transfer Method (RS-485/422) Settings |
| 8 | Response Mode Settings |
| 9 | Backup Mode Settings 1 |
| 10~11 | Termination Settings |
| 12 | Backup Mode Settings 2 |

• Protocol Settings

Select a communication protocol for the camera

| No | Protocol | SW2-#1 | SW2-#2 | SW2-#3 | SW2-#4 |
|----|---------------|--------|--------|--------|--------|
| 1 | Samsung | OFF | OFF | OFF | OFF |
| 2 | Pelco-D | OFF | OFF | OFF | ON |
| 3 | Pelco-P | OFF | OFF | ON | OFF |
| 4 | Samsung Elec. | OFF | OFF | ON | ON |
| 5 | Panasonic | OFF | ON | OFF | OFF |
| 6 | Vicon | OFF | ON | OFF | ON |
| 7 | Honeywell | OFF | ON | ON | OFF |
| 8 | AD | OFF | ON | ON | ON |
| 9 | Reserved | ON | OFF | OFF | OFF |
| 10 | Reserved | ON | OFF | OFF | ON |
| 11 | Reserved | ON | OFF | ON | OFF |
| 12 | Reserved | ON | OFF | ON | ON |
| 13 | Reserved | ON | ON | OFF | OFF |
| 14 | Reserved | ON | ON | OFF | ON |
| 15 | Reserved | ON | ON | ON | OFF |
| 16 | Reserved | ON | ON | ON | ON |

Installing Your Camera

• Baud Rate Settings

Select the transfer speed of a selected communication protocol.

| No. | Baud Rate(BPS) | SW2-#5 | SW2-#6 |
|-----|----------------|--------|--------|
| 1 | 2,400 | ON | ON |
| 2 | 4,800 | ON | OFF |
| 3 | 9,600 | OFF | OFF |
| 4 | 19,200 | OFF | ON |

• Communication Method Settings

Select a communication method for the camera.

| | Function | ON | OFF |
|---------|----------------------|---------------|---------------|
| SW2- #7 | Transfer Mode Switch | RS-422(4Wire) | RS-485(2Wire) |

• Communication Response Settings

Select a communication response method for the camera and controller: Response or No Response.

| | Function | ON | OFF |
|---------|----------------------|----------|-------------|
| SW2- #8 | Response Mode Switch | Response | No Response |

• Termination Settings

To prevent the attenuation of communication signals between the camera and controller, 2 cameras in a longest distance for the camera and controller communication loop must be set up with the termination settings.

| Camera Input Position | SW2- #10 | SW2- #11 |
|-----------------------------|----------|----------|
| Termination of Longest Path | ON | ON |
| On the Path | OFF | OFF |

Installing Your Camera

• Camera Backup Settings

These settings are useful when the camera or its install base are damaged or malfunctions occur. When replacing the camera or its install base, you can transfer existing presets and sequence information to the replacement using these settings.

| Backup Function | SW2- #9 | SW2- #12 |
|-----------------|---------|----------|
| Backup(IB→D) | OFF | OFF |
| Backup(D→IB) | ON | OFF |
| Backup Disable | - | ON |

- Backup(IB→D) : Enables transferring the current camera's sequence information to a new camera.
- Backup(D→IB) : Enables transferring the current camera's sequence information to a new install base.

*IB: Install base, D: Dome Camera



Notes

- To use a third party controller with this product, please contact our After-Sales Service or Technology Department.
- AD Protocol Control Method
 - Input Camera OSD: 3+Auxiliary On
 - Output Camera OSD: 3+Auxiliary Off
 - Enter: IRIS Open
 - ESC: IRIS Close
- For more information about the protocols, refer to our official website.

Camera ID DIP Switch Settings (SW1)

To set up camera IDs, refer to the "Camera ID Chart" next.

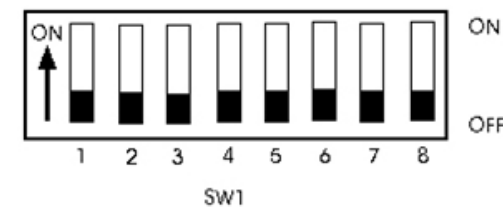

Installing Your Camera

• Camera ID Chart

| ID | SW1-#1 | SW1-#2 | SW1-#3 | SW1-#4 | SW1-#5 | SW1-#6 | SW1-#7 | SW1-#8 |
|----|--------|--------|--------|--------|--------|--------|--------|--------|
| 1 | ON/OFF | OFF | OFF | OFF | OFF | OFF | OFF | OFF |
| 2 | OFF | ON | OFF | OFF | OFF | OFF | OFF | OFF |
| 3 | ON | ON | OFF | OFF | OFF | OFF | OFF | OFF |
| 4 | OFF | OFF | ON | OFF | OFF | OFF | OFF | OFF |
| 5 | ON | OFF | ON | OFF | OFF | OFF | OFF | OFF |
| 6 | OFF | ON | ON | OFF | OFF | OFF | OFF | OFF |
| 7 | ON | ON | ON | OFF | OFF | OFF | OFF | OFF |
| 8 | OFF | OFF | OFF | ON | OFF | OFF | OFF | OFF |
| 9 | ON | OFF | OFF | ON | OFF | OFF | OFF | OFF |
| 10 | OFF | ON | OFF | ON | OFF | OFF | OFF | OFF |
| 11 | ON | ON | OFF | ON | OFF | OFF | OFF | OFF |
| 12 | OFF | OFF | ON | ON | OFF | OFF | OFF | OFF |
| 13 | ON | OFF | ON | ON | OFF | OFF | OFF | OFF |
| 14 | OFF | ON | ON | ON | OFF | OFF | OFF | OFF |
| 15 | ON | ON | ON | ON | OFF | OFF | OFF | OFF |
| 16 | OFF | OFF | OFF | OFF | ON | OFF | OFF | OFF |
| 17 | ON | OFF | OFF | OFF | ON | OFF | OFF | OFF |
| 18 | OFF | ON | OFF | OFF | ON | OFF | OFF | OFF |
| 19 | ON | ON | OFF | OFF | ON | OFF | OFF | OFF |
| 20 | OFF | OFF | ON | OFF | ON | OFF | OFF | OFF |
| 21 | ON | OFF | ON | OFF | ON | OFF | OFF | OFF |
| 22 | OFF | ON | ON | OFF | ON | OFF | OFF | OFF |
| 23 | ON | ON | ON | OFF | ON | OFF | OFF | OFF |
| 24 | OFF | OFF | OFF | ON | ON | OFF | OFF | OFF |
| 25 | ON | OFF | OFF | ON | ON | OFF | OFF | OFF |
| 26 | OFF | ON | OFF | ON | ON | OFF | OFF | OFF |
| 27 | ON | ON | OFF | ON | ON | OFF | OFF | OFF |
| 28 | OFF | OFF | ON | ON | ON | OFF | OFF | OFF |
| 29 | ON | OFF | ON | ON | ON | OFF | OFF | OFF |
| 30 | OFF | ON | ON | ON | ON | OFF | OFF | OFF |
| 31 | ON | ON | ON | ON | ON | OFF | OFF | OFF |
| 32 | OFF | OFF | OFF | OFF | OFF | ON | OFF | OFF |
| 33 | ON | OFF | OFF | OFF | OFF | ON | OFF | OFF |
| 34 | OFF | ON | OFF | OFF | OFF | ON | OFF | OFF |
| 35 | ON | ON | OFF | OFF | OFF | ON | OFF | OFF |
| 36 | OFF | OFF | ON | OFF | OFF | ON | OFF | OFF |
| 37 | ON | OFF | ON | OFF | OFF | ON | OFF | OFF |
| 38 | OFF | ON | ON | OFF | OFF | ON | OFF | OFF |
| 39 | ON | ON | ON | OFF | OFF | ON | OFF | OFF |
| 40 | OFF | OFF | OFF | ON | OFF | ON | OFF | OFF |
| 41 | ON | OFF | OFF | ON | OFF | ON | OFF | OFF |

Installing Your Camera

| ID | SW1-#1 | SW1-#2 | SW1-#3 | SW1-#4 | SW1-#5 | SW1-#6 | SW1-#7 | SW1-#8 |
|----|--------|--------|--------|--------|--------|--------|--------|--------|
| 42 | OFF | ON | OFF | ON | OFF | ON | OFF | OFF |
| 43 | ON | ON | OFF | ON | OFF | ON | OFF | OFF |
| 44 | OFF | OFF | ON | ON | OFF | ON | OFF | OFF |
| 45 | ON | OFF | ON | ON | OFF | ON | OFF | OFF |
| 46 | OFF | ON | ON | ON | OFF | ON | OFF | OFF |
| 47 | ON | ON | ON | ON | OFF | ON | OFF | OFF |
| 48 | OFF | OFF | OFF | OFF | ON | ON | OFF | OFF |
| 49 | ON | OFF | OFF | OFF | ON | ON | OFF | OFF |
| 50 | OFF | ON | OFF | OFF | ON | ON | OFF | OFF |
| 51 | ON | ON | OFF | OFF | ON | ON | OFF | OFF |
| 52 | OFF | OFF | ON | OFF | ON | ON | OFF | OFF |
| 53 | ON | OFF | ON | OFF | ON | ON | OFF | OFF |
| 54 | OFF | ON | ON | OFF | ON | ON | OFF | OFF |
| 55 | ON | ON | ON | OFF | ON | ON | OFF | OFF |
| 56 | OFF | OFF | OFF | ON | ON | ON | OFF | OFF |
| 57 | ON | OFF | OFF | ON | ON | ON | OFF | OFF |
| 58 | OFF | ON | OFF | ON | ON | ON | OFF | OFF |
| 59 | ON | ON | OFF | ON | ON | ON | OFF | OFF |
| 60 | OFF | OFF | ON | ON | ON | ON | OFF | OFF |
| 61 | ON | OFF | ON | ON | ON | ON | OFF | OFF |
| 62 | OFF | ON | ON | ON | ON | ON | OFF | OFF |
| 63 | ON | ON | ON | ON | ON | ON | OFF | OFF |
| 64 | OFF | OFF | OFF | OFF | OFF | OFF | ON | OFF |
| 65 | ON | OFF | OFF | OFF | OFF | OFF | ON | OFF |
| 66 | OFF | ON | OFF | OFF | OFF | OFF | ON | OFF |
| 67 | ON | ON | OFF | OFF | OFF | OFF | ON | OFF |
| 68 | OFF | OFF | ON | OFF | OFF | OFF | ON | OFF |
| 69 | ON | OFF | ON | OFF | OFF | OFF | ON | OFF |
| 70 | OFF | ON | ON | OFF | OFF | OFF | ON | OFF |
| 71 | ON | ON | ON | OFF | OFF | OFF | ON | OFF |
| 72 | OFF | OFF | OFF | ON | OFF | OFF | ON | OFF |
| 73 | ON | OFF | OFF | ON | OFF | OFF | ON | OFF |
| 74 | OFF | ON | OFF | ON | OFF | OFF | ON | OFF |
| 75 | ON | ON | OFF | ON | OFF | OFF | ON | OFF |
| 76 | OFF | OFF | ON | ON | OFF | OFF | ON | OFF |
| 77 | ON | OFF | ON | ON | OFF | OFF | ON | OFF |
| 78 | OFF | ON | ON | ON | OFF | OFF | ON | OFF |
| 79 | ON | ON | ON | ON | OFF | OFF | ON | OFF |
| 80 | OFF | OFF | OFF | OFF | ON | OFF | ON | OFF |
| 81 | ON | OFF | OFF | OFF | ON | OFF | ON | OFF |
| 82 | OFF | ON | OFF | OFF | ON | OFF | ON | OFF |
| 83 | ON | ON | OFF | OFF | ON | OFF | ON | OFF |
| 84 | OFF | OFF | ON | OFF | ON | OFF | ON | OFF |

Installing Your Camera

| ID | SW1-#1 | SW1-#2 | SW1-#3 | SW1-#4 | SW1-#5 | SW1-#6 | SW1-#7 | SW1-#8 |
|-----|--------|--------|--------|--------|--------|--------|--------|--------|
| 85 | ON | OFF | ON | OFF | ON | OFF | ON | OFF |
| 86 | OFF | ON | ON | OFF | ON | OFF | ON | OFF |
| 87 | ON | ON | ON | OFF | ON | OFF | ON | OFF |
| 88 | OFF | OFF | OFF | ON | ON | OFF | ON | OFF |
| 89 | ON | OFF | OFF | ON | ON | OFF | ON | OFF |
| 90 | OFF | ON | OFF | ON | ON | OFF | ON | OFF |
| 91 | ON | ON | OFF | ON | ON | OFF | ON | OFF |
| 92 | OFF | OFF | ON | ON | ON | OFF | ON | OFF |
| 93 | ON | OFF | ON | ON | ON | OFF | ON | OFF |
| 94 | OFF | ON | ON | ON | ON | OFF | ON | OFF |
| 95 | ON | ON | ON | ON | ON | OFF | ON | OFF |
| 96 | OFF | OFF | OFF | OFF | OFF | ON | ON | OFF |
| 97 | ON | OFF | OFF | OFF | OFF | ON | ON | OFF |
| 98 | OFF | ON | OFF | OFF | OFF | ON | ON | OFF |
| 99 | ON | ON | OFF | OFF | OFF | ON | ON | OFF |
| 100 | OFF | OFF | ON | OFF | OFF | ON | ON | OFF |
| 101 | ON | OFF | ON | OFF | OFF | ON | ON | OFF |
| 102 | OFF | ON | ON | OFF | OFF | ON | ON | OFF |
| 103 | ON | ON | ON | OFF | OFF | ON | ON | OFF |
| 104 | OFF | OFF | OFF | ON | OFF | ON | ON | OFF |
| 105 | ON | OFF | OFF | ON | OFF | ON | ON | OFF |
| 106 | OFF | ON | OFF | ON | OFF | ON | ON | OFF |
| 107 | ON | ON | OFF | ON | OFF | ON | ON | OFF |
| 108 | OFF | OFF | ON | ON | OFF | ON | ON | OFF |
| 109 | ON | OFF | ON | ON | OFF | ON | ON | OFF |
| 110 | OFF | ON | ON | ON | OFF | ON | ON | OFF |
| 111 | ON | ON | ON | ON | OFF | ON | ON | OFF |
| 112 | OFF | OFF | OFF | OFF | ON | ON | ON | OFF |
| 113 | ON | OFF | OFF | OFF | ON | ON | ON | OFF |
| 114 | OFF | ON | OFF | OFF | ON | ON | ON | OFF |
| 115 | ON | ON | OFF | OFF | ON | ON | ON | OFF |
| 116 | OFF | OFF | ON | OFF | ON | ON | ON | OFF |
| 117 | ON | OFF | ON | OFF | ON | ON | ON | OFF |
| 118 | OFF | ON | ON | OFF | ON | ON | ON | OFF |
| 119 | ON | ON | ON | OFF | ON | ON | ON | OFF |
| 120 | OFF | OFF | OFF | ON | ON | ON | ON | OFF |
| 121 | ON | OFF | OFF | ON | ON | ON | ON | OFF |
| 122 | OFF | ON | OFF | ON | ON | ON | ON | OFF |
| 123 | ON | ON | OFF | ON | ON | ON | ON | OFF |
| 124 | OFF | OFF | ON | ON | ON | ON | ON | OFF |
| 125 | ON | OFF | ON | ON | ON | ON | ON | OFF |
| 126 | OFF | ON | ON | ON | ON | ON | ON | OFF |
| 127 | ON | ON | ON | ON | ON | ON | ON | OFF |

Installing Your Camera

| ID | SW1-#1 | SW1-#2 | SW1-#3 | SW1-#4 | SW1-#5 | SW1-#6 | SW1-#7 | SW1-#8 |
|-----|--------|--------|--------|--------|--------|--------|--------|--------|
| 128 | OFF | OFF | OFF | OFF | OFF | OFF | OFF | ON |
| 129 | ON | OFF | OFF | OFF | OFF | OFF | OFF | ON |
| 130 | OFF | ON | OFF | OFF | OFF | OFF | OFF | ON |
| 131 | ON | ON | OFF | OFF | OFF | OFF | OFF | ON |
| 132 | OFF | OFF | ON | OFF | OFF | OFF | OFF | ON |
| 133 | ON | OFF | ON | OFF | OFF | OFF | OFF | ON |
| 134 | OFF | ON | ON | OFF | OFF | OFF | OFF | ON |
| 135 | ON | ON | ON | OFF | OFF | OFF | OFF | ON |
| 136 | OFF | OFF | OFF | ON | OFF | OFF | OFF | ON |
| 137 | ON | OFF | OFF | ON | OFF | OFF | OFF | ON |
| 138 | OFF | ON | OFF | ON | OFF | OFF | OFF | ON |
| 139 | ON | ON | OFF | ON | OFF | OFF | OFF | ON |
| 140 | OFF | OFF | ON | ON | OFF | OFF | OFF | ON |
| 141 | ON | OFF | ON | ON | OFF | OFF | OFF | ON |
| 142 | OFF | ON | ON | ON | OFF | OFF | OFF | ON |
| 143 | ON | ON | ON | ON | OFF | OFF | OFF | ON |
| 144 | OFF | OFF | OFF | OFF | ON | OFF | OFF | ON |
| 145 | ON | OFF | OFF | OFF | ON | OFF | OFF | ON |
| 146 | OFF | ON | OFF | OFF | ON | OFF | OFF | ON |
| 147 | ON | ON | OFF | OFF | ON | OFF | OFF | ON |
| 148 | OFF | OFF | ON | OFF | ON | OFF | OFF | ON |
| 149 | ON | OFF | ON | OFF | ON | OFF | OFF | ON |
| 150 | OFF | ON | ON | OFF | ON | OFF | OFF | ON |
| 151 | ON | ON | ON | OFF | ON | OFF | OFF | ON |
| 152 | OFF | OFF | OFF | ON | ON | OFF | OFF | ON |
| 153 | ON | OFF | OFF | ON | ON | OFF | OFF | ON |
| 154 | OFF | ON | OFF | ON | ON | OFF | OFF | ON |
| 155 | ON | ON | OFF | ON | ON | OFF | OFF | ON |
| 156 | OFF | OFF | ON | ON | ON | OFF | OFF | ON |
| 157 | ON | OFF | ON | ON | ON | OFF | OFF | ON |
| 158 | OFF | ON | ON | ON | ON | OFF | OFF | ON |
| 159 | ON | ON | ON | ON | ON | OFF | OFF | ON |
| 160 | OFF | OFF | OFF | OFF | OFF | ON | OFF | ON |
| 161 | ON | OFF | OFF | OFF | OFF | ON | OFF | ON |
| 162 | OFF | ON | OFF | OFF | OFF | ON | OFF | ON |
| 163 | ON | ON | OFF | OFF | OFF | ON | OFF | ON |
| 164 | OFF | OFF | ON | OFF | OFF | ON | OFF | ON |
| 165 | ON | OFF | ON | OFF | OFF | ON | OFF | ON |
| 166 | OFF | ON | ON | OFF | OFF | ON | OFF | ON |
| 167 | ON | ON | ON | OFF | OFF | ON | OFF | ON |
| 168 | OFF | OFF | OFF | ON | OFF | ON | OFF | ON |
| 169 | ON | OFF | OFF | ON | OFF | ON | OFF | ON |
| 170 | OFF | ON | OFF | ON | OFF | ON | OFF | ON |

Installing Your Camera

| ID | SW1-#1 | SW1-#2 | SW1-#3 | SW1-#4 | SW1-#5 | SW1-#6 | SW1-#7 | SW1-#8 |
|-----|--------|--------|--------|--------|--------|--------|--------|--------|
| 171 | ON | ON | OFF | ON | OFF | ON | OFF | ON |
| 172 | OFF | OFF | ON | ON | OFF | ON | OFF | ON |
| 173 | ON | OFF | ON | ON | OFF | ON | OFF | ON |
| 174 | OFF | ON | ON | ON | OFF | ON | OFF | ON |
| 175 | ON | ON | ON | ON | OFF | ON | OFF | ON |
| 176 | OFF | OFF | OFF | OFF | ON | ON | OFF | ON |
| 177 | ON | OFF | OFF | OFF | ON | ON | OFF | ON |
| 178 | OFF | ON | OFF | OFF | ON | ON | OFF | ON |
| 179 | ON | ON | OFF | OFF | ON | ON | OFF | ON |
| 180 | OFF | OFF | ON | OFF | ON | ON | OFF | ON |
| 181 | ON | OFF | ON | OFF | ON | ON | OFF | ON |
| 182 | OFF | ON | ON | OFF | ON | ON | OFF | ON |
| 183 | ON | ON | ON | OFF | ON | ON | OFF | ON |
| 184 | OFF | OFF | OFF | ON | ON | ON | OFF | ON |
| 185 | ON | OFF | OFF | ON | ON | ON | OFF | ON |
| 186 | OFF | ON | OFF | ON | ON | ON | OFF | ON |
| 187 | ON | ON | OFF | ON | ON | ON | OFF | ON |
| 188 | OFF | OFF | ON | ON | ON | ON | OFF | ON |
| 189 | ON | OFF | ON | ON | ON | ON | OFF | ON |
| 190 | OFF | ON | ON | ON | ON | ON | OFF | ON |
| 191 | ON | ON | ON | ON | ON | ON | OFF | ON |
| 192 | OFF | OFF | OFF | OFF | OFF | OFF | ON | ON |
| 193 | ON | OFF | OFF | OFF | OFF | OFF | ON | ON |
| 194 | OFF | ON | OFF | OFF | OFF | OFF | ON | ON |
| 195 | ON | ON | OFF | OFF | OFF | OFF | ON | ON |
| 196 | OFF | OFF | ON | OFF | OFF | OFF | ON | ON |
| 197 | ON | OFF | ON | OFF | OFF | OFF | ON | ON |
| 198 | OFF | ON | ON | OFF | OFF | OFF | ON | ON |
| 199 | ON | ON | ON | OFF | OFF | OFF | ON | ON |
| 200 | OFF | OFF | OFF | ON | OFF | OFF | ON | ON |
| 201 | ON | OFF | OFF | ON | OFF | OFF | ON | ON |
| 202 | OFF | ON | OFF | ON | OFF | OFF | ON | ON |
| 203 | ON | ON | OFF | ON | OFF | OFF | ON | ON |
| 204 | OFF | OFF | ON | ON | OFF | OFF | ON | ON |
| 205 | ON | OFF | ON | ON | OFF | OFF | ON | ON |
| 206 | OFF | ON | ON | ON | OFF | OFF | ON | ON |
| 207 | ON | ON | ON | ON | OFF | OFF | ON | ON |
| 208 | OFF | OFF | OFF | OFF | ON | OFF | ON | ON |
| 209 | ON | OFF | OFF | OFF | ON | OFF | ON | ON |
| 210 | OFF | ON | OFF | OFF | ON | OFF | ON | ON |
| 211 | ON | ON | OFF | OFF | ON | OFF | ON | ON |
| 212 | OFF | OFF | ON | OFF | ON | OFF | ON | ON |
| 213 | ON | OFF | ON | OFF | ON | OFF | ON | ON |

Installing Your Camera

| ID | SW1-#1 | SW1-#2 | SW1-#3 | SW1-#4 | SW1-#5 | SW1-#6 | SW1-#7 | SW1-#8 |
|-----|--------|--------|--------|--------|--------|--------|--------|--------|
| 214 | OFF | ON | ON | OFF | ON | OFF | ON | ON |
| 215 | ON | ON | ON | OFF | ON | OFF | ON | ON |
| 216 | OFF | OFF | OFF | ON | ON | OFF | ON | ON |
| 217 | ON | OFF | OFF | ON | ON | OFF | ON | ON |
| 218 | OFF | ON | OFF | ON | ON | OFF | ON | ON |
| 219 | ON | ON | OFF | ON | ON | OFF | ON | ON |
| 220 | OFF | OFF | ON | ON | ON | OFF | ON | ON |
| 221 | ON | OFF | ON | ON | ON | OFF | ON | ON |
| 222 | OFF | ON | ON | ON | ON | OFF | ON | ON |
| 223 | ON | ON | ON | ON | ON | OFF | ON | ON |
| 224 | OFF | OFF | OFF | OFF | OFF | ON | ON | ON |
| 225 | ON | OFF | OFF | OFF | OFF | ON | ON | ON |
| 226 | OFF | ON | OFF | OFF | OFF | ON | ON | ON |
| 227 | ON | ON | OFF | OFF | OFF | ON | ON | ON |
| 228 | OFF | OFF | ON | OFF | OFF | ON | ON | ON |
| 229 | ON | OFF | ON | OFF | OFF | ON | ON | ON |
| 230 | OFF | ON | ON | OFF | OFF | ON | ON | ON |
| 231 | ON | ON | ON | OFF | OFF | ON | ON | ON |
| 232 | OFF | OFF | OFF | ON | OFF | ON | ON | ON |
| 233 | ON | OFF | OFF | ON | OFF | ON | ON | ON |
| 234 | OFF | ON | OFF | ON | OFF | ON | ON | ON |
| 235 | ON | ON | OFF | ON | OFF | ON | ON | ON |
| 236 | OFF | OFF | ON | ON | OFF | ON | ON | ON |
| 237 | ON | OFF | ON | ON | OFF | ON | ON | ON |
| 238 | OFF | ON | ON | ON | OFF | ON | ON | ON |
| 239 | ON | ON | ON | ON | OFF | ON | ON | ON |
| 240 | OFF | OFF | OFF | OFF | ON | ON | ON | ON |
| 241 | ON | OFF | OFF | OFF | ON | ON | ON | ON |
| 242 | OFF | ON | OFF | OFF | ON | ON | ON | ON |
| 243 | ON | ON | OFF | OFF | ON | ON | ON | ON |
| 244 | OFF | OFF | ON | OFF | ON | ON | ON | ON |
| 245 | ON | OFF | ON | OFF | ON | ON | ON | ON |
| 246 | OFF | ON | ON | OFF | ON | ON | ON | ON |
| 247 | ON | ON | ON | OFF | ON | ON | ON | ON |
| 248 | OFF | OFF | OFF | ON | ON | ON | ON | ON |
| 249 | ON | OFF | OFF | ON | ON | ON | ON | ON |
| 250 | OFF | ON | OFF | ON | ON | ON | ON | ON |
| 251 | ON | ON | OFF | ON | ON | ON | ON | ON |
| 252 | OFF | OFF | ON | ON | ON | ON | ON | ON |
| 253 | ON | OFF | ON | ON | ON | ON | ON | ON |
| 254 | OFF | ON | ON | ON | ON | ON | ON | ON |
| 255 | ON | ON | ON | ON | ON | ON | ON | ON |

Installing Your Camera

Preparing Adapter and Cables

- Power Adapter
Power adapter has the capacity of AC24V 2.5A.

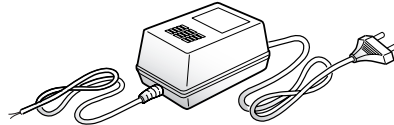

- Video Cable
A BNC coaxial cable shown in the picture is required to connect Speed Dome's video output terminal to the monitor.

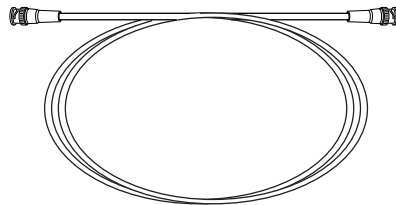

| Distance | Recommended Cable Specification |
|-----------------|---------------------------------|
| 500m or shorter | 5C2V Coaxial Cable |
| 500m or longer | 7C2V Coaxial Cable |

- Communications Cable
For the camera to communicate with the controller, a RS-485/422 communications line is required. To ensure the quality of long distance communications and the accuracy of the overall communications, using a twisted pair cable such as UTP Cable is recommended.

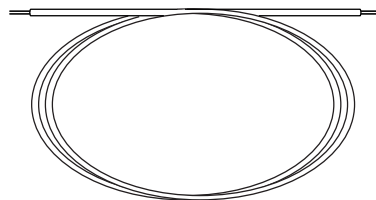

- * **Caution!**
Depending on the camera's environment, the communications distance may vary.

Notes

- Neither the video nor communications cable is enclosed with the camera.

Installing Your Camera

Preparing and Installing Camera Bracket

For the installation guidelines for the brackets and housings, refer to the user's manual enclosed with the bracket or housing that is sold separately.

• Camera Wiring Diagram 1

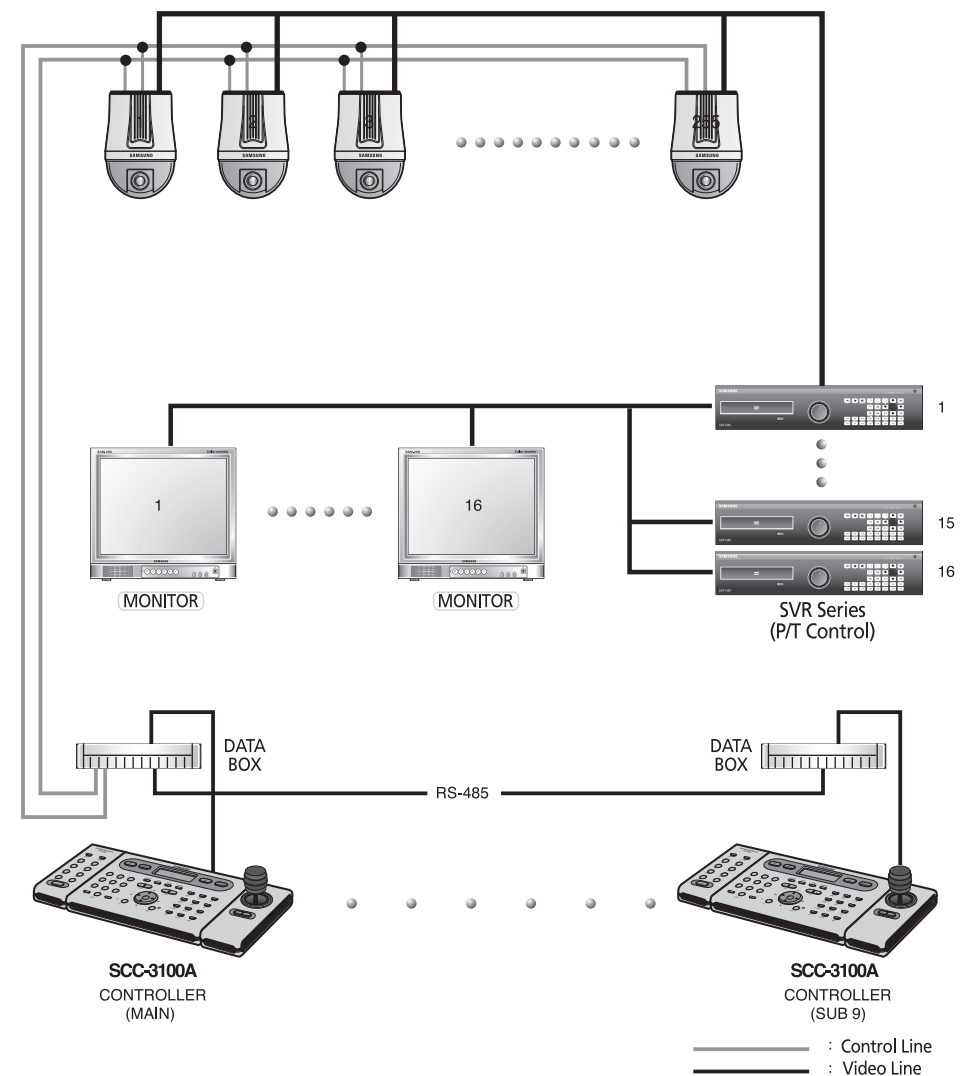

Installing Your Camera

• Camera Wiring Diagram 2

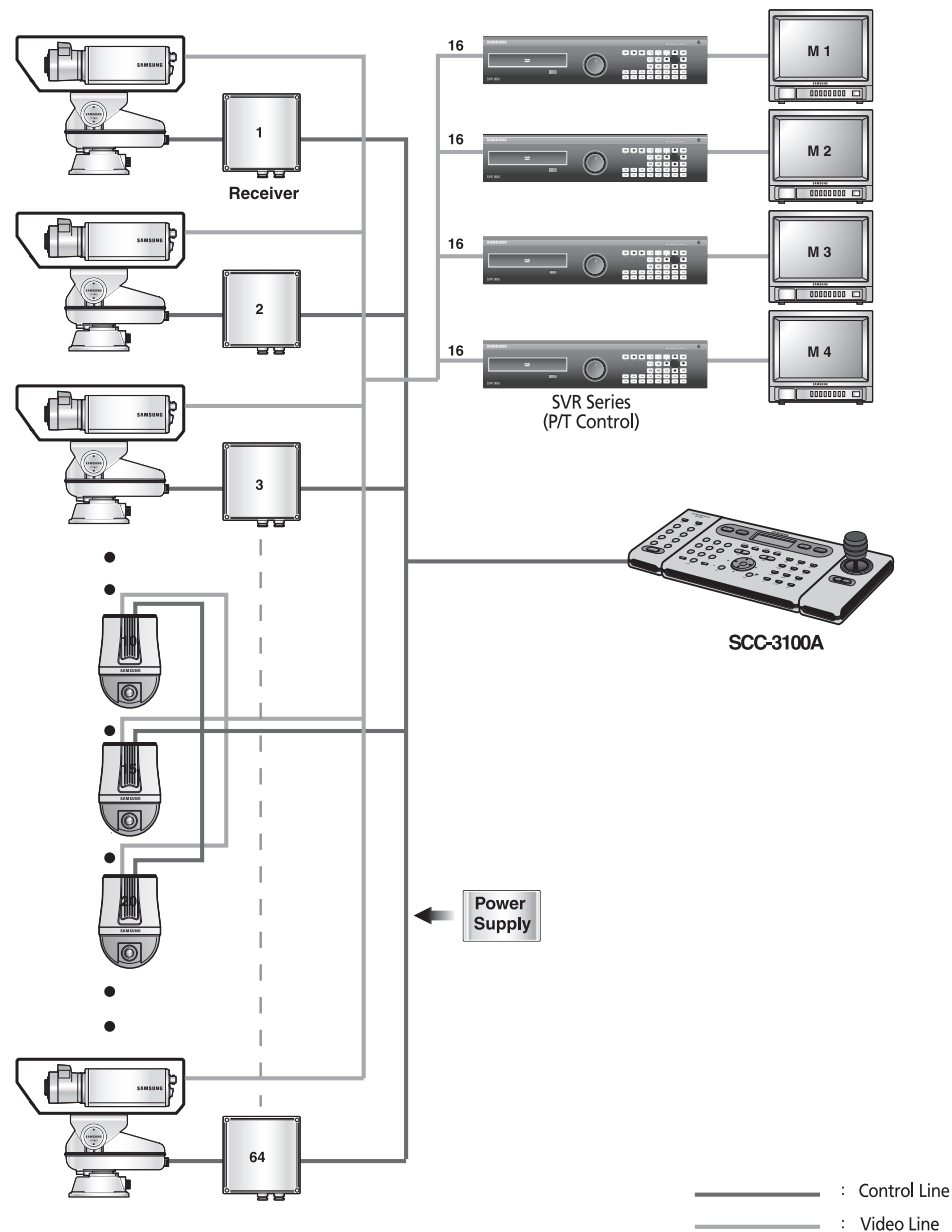

Installing Your Camera

On-Ceiling Mount Type Installation Example

1. Attaching Template and Installing STB-370PC

Attach the enclosed template to the ceiling, then drill a hole in the ceiling according to the diameter marked on the template. Drop the camera cables down from the ceiling through the hole. Next, install the exposed bracket STB-370PC to the ceiling as shown in the picture. Before installing the exposed bracket, open the hinged door at the bottom of the bracket as shown in the picture. Hold the knob on the hinged door to open.

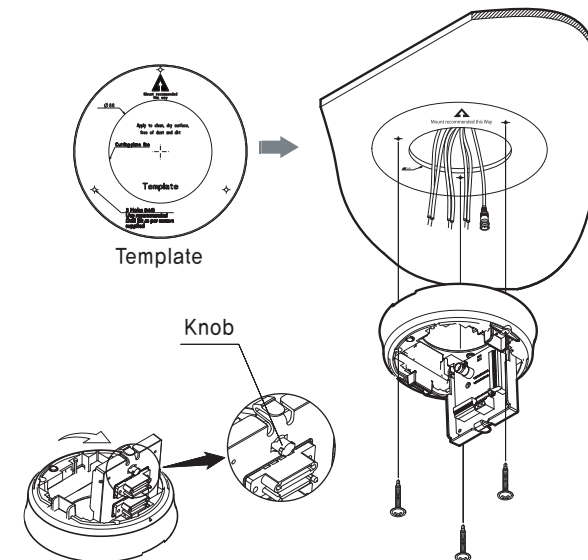

2. Wiring Terminal Cables

Connect the cables to the terminal block on the hinged door. For the location of the wiring pins, please refer to the "Camera Wiring Diagram" on Page 14. Once the wiring is successful, close the hinged door.

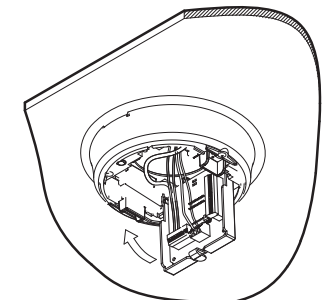

Notes

- Do not connect the camera to a power outlet until the installation is complete. Supplying power in the middle of the installation may cause fire or damage the product.

Installing Your Camera

3. Setting Up Camera DIP Switches

DIP switches for communication and ID protocols are located on the bottom of the camera. For the switch settings, refer to the dip switch settings of this manual.

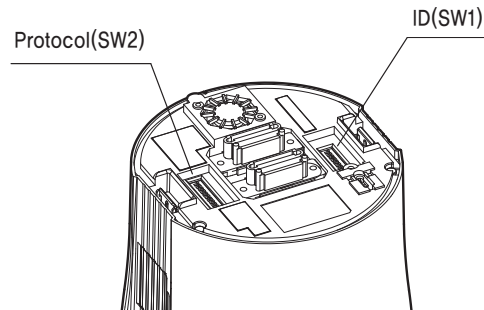

5. Connecting Camera Safety Cable and Attaching Camera

Carefully attach the camera to the mount following the alignment guide marks as shown in the picture. First hook the camera's safety cable on the mount, and then attach the camera.

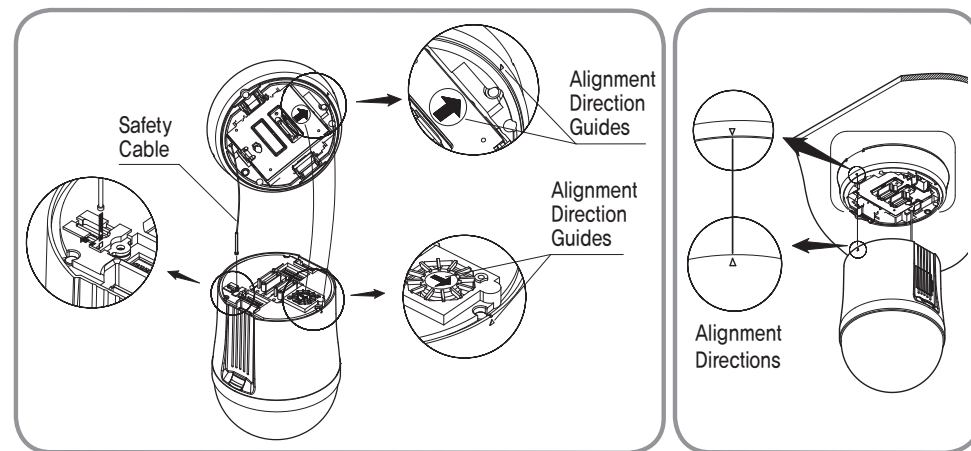

* To attach the camera to the mount, refer to the alignment guide marks as shown in the picture.

Notes

- Make sure to first hook the camera's safety cable to the mount before proceeding. Otherwise you may be exposed to serious injury caused by a fallen camera.

Installing Your Camera

* To attach or detach the camera, refer to the picture.

* Attaching the camera: Hold up the camera and push it to the mount as shown in the picture. Push the camera until you hear a "click".

* Detaching the camera: To detach the camera, pull the camera downward while pushing the unlock buttons on the camera upward.

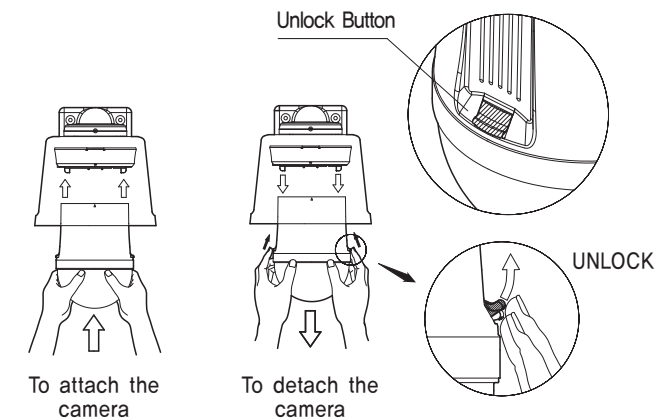

Interface Symbols

- **Motion Detection Standby/Operation Display :**
 - When in standby mode, the "D" in the upper right of the screen blinks and then changes to "A" if motion is detected.
- **Alarm Input Port Status Display :**
 - "1", "2", "3" and "4" in the upper right of the screen blink.
- **Current Alarm Port Display According to Input Alarm Ports(Priority) :**
 - Only one of "1", "2", "3", "4" in the upper right of the screen blinks.
- **Preset Number Display Settings :**
 - '*' : If a preset number is already available
 - 'H' : If a preset location is the camera's home position
 - 'T' : If a preset location is the camera's Auto Track starting point (SPD-3700T Only)
- **If an OSD Menu has Sub Menus :**
 - The color of the circle around the menu number shows as embossed, e.g. "1".
- **If an OSD Menu Does Not Have Sub Menus :**
 - The circle around the menu number shows as engraved, e.g. "1".

• PTZ Function Screen :

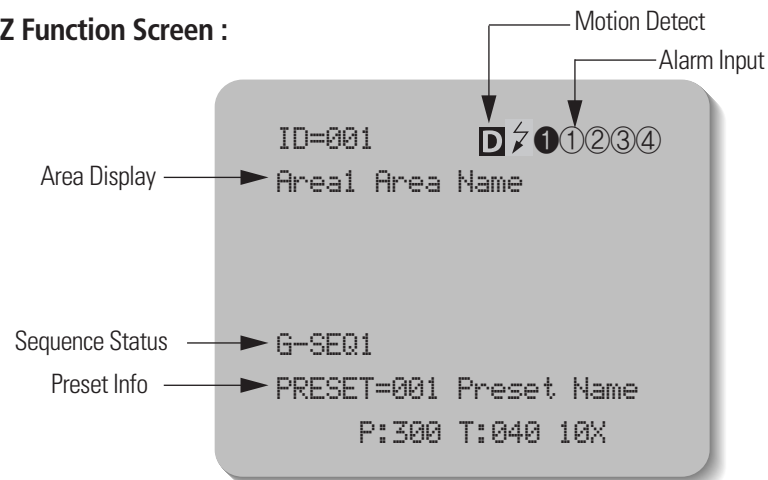

• Preset Number Setting Screen :

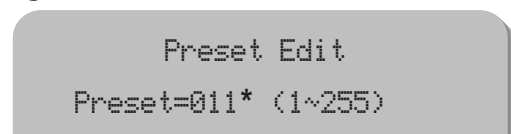

Operating Your Camera

• OSD Menu Screen :

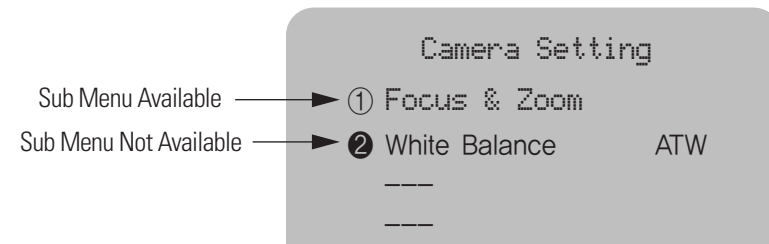

Operating Your Camera

- **Panning and Tilting**
 - Use the joystick of the controller or its direction buttons.
- **Controlling Zoon**
 - Move the joystick clockwise (Tele) or counterclockwise (Wide), or use the Zoom button.
- **Accessing Screen Menus**
 - Press the Menu or OSD button on the controller.

* For more detailed information about controls using a third party controller or a DVR, refer to the user's manual of the product.

OSD Commands, Function Chart, and Menu Controls

This dome camera can be operated using two methods: Using hot keys on its dedicated controller, or accessing the OSD (On Screen Display) on the video output. The OSD menu commands are as follows:

| Command | Function |
|--------------------------------------|--|
| Move the joystick up/down/left/right | Moves the OSD menu up/down/left/right, respectively. |
| Enter/Focus Far | Selects a menu and allows access to the sub menus. |
| ESC/Focus Near | Cancels a command and moves back to an upper-level menu. |

Dome Cover Setting

Before optimizing the camera focus settings for the dome cover shape, please select the dome cover type on the camera's main menu. (Refer to Page 48)

| Dome Cover Setting | Installation Type |
|--------------------|---|
| Outer | Dome cover type for outdoor housings except the indoor flush model. |
| Inner | Default dome cover type including the indoor flush model. |
| None | When using the camera without a dome cover. |

Operating Your Camera

*OSD Menu Chart

| P1 | P2 | P3 | P4 | P5 | Default | |
|------------------|---|-----------------------------|--|-------------------------------|-------------|-------|
| ① Camera Setting | ① Focus & Zoom | ① Focus Mode | Auto/Manual/One Shot AF | | One Shot AF | |
| | | ② Zoom Tracking | Mode | Auto/Tracking/Off | Auto | |
| | | | Speed | Slow/Medium/Fast | Fast | |
| | | ③ Digital Zoom | Off/2X/3X/4X/5X/.../12X | | Off | |
| | ② White Balance | AWB Mode | ATW/INDOOR/OUTDOOR/AWC | | ATW | |
| | | | Manual | Red Blue | 117 93 | |
| | | ① Brightness | 0~100 | | 50 | |
| | ③ Exposure | ② Iris | Auto | | Auto | |
| | | | Manual | Iris Level | F1.6 | |
| | | ③ Shutter | ---/A,FLK/Manual | | --- | |
| | | ④ Sens-Up | Auto/Off | Sens-Up Limit X2/X4...X256 | Auto(X2) | |
| | ④ Back Light | ① Off | | | Off | |
| | | ② HLC | Level | Low/High | Low | |
| | | | Mask Color | 0~10 | 5 | |
| | | ③ User | Up/Down/Left/Right/ Increase/Decrease | | | |
| | ⑤ AGC | Off/Low/Medium/High | | | Medium | |
| | | Manual | Level | 5~41 | 5 dB | |
| | ⑥ SSNR | Off/Low/Medium/High | | | Medium | |
| | | ⑦ Day & Night | Mode | Auto | | Color |
| | Color | | | Burst Level 0~100 | | |
| | B/W | | | Burst On/Off | | |
| | Duration | | Slow/Fast | | Fast | |
| | | Dwell Time | 5/7/10/15/20/30/40/60 Sec | | 5 Sec | |
| | ⑧ Others | Sync | Internal | | Internal | |
| | | | Line Lock | Line Lock Phase | | |
| | | Stabilizer | On/Off | | Off | |
| | | Image Adj. | ① Sharpness | On(0~32)/Off | | 24 |
| | | | ② Color | 0~100 | | 50 |
| | | Freeze | On/Off | | Off | |
| | | Dome Cover | Inner/Outer/None | | Inner | |
| ① Preset | ① Setting ② Edit ③ Home Position ④ Execute ⑤ Clear ⑥ Status | | | | | |
| | ② Swing SEQ. | ① Pan Swing | ① Setting ② Execute ③ Clear | | | |
| | | ② Tilt Swing | ① Setting ② Execute ③ Clear | | | |
| | ③ P&T Swing | ① Setting ② Execute ③ Clear | | | | |

Operating Your Camera

| | | | | | |
|--------------------|-------------------|-----------------------------|--|-------|--------|
| ② Sequence Setting | ③ Group SEQ. | Group1~6 | ① Setting ② Execute ③ Clear | | |
| | ④ Tour SEQ. | ① Setting ② Execute ③ Clear | | | |
| | ⑤ PTZ Trace | Trace1~4 | ① Replay ② Memorize | | |
| | ⑥ Auto Run | ① Mode | Off/Home/Preset/Swing/Group/ Tour/Trace/A_Pan | | Off |
| | | ② Time | 1~60(Sec), 1~60(Min) | | 30 Sec |
| | ⑦ Power On Resume | On/Off | | | On |
| | ⑧ MD Dwell Time | ① Off | | | |
| | | ② On | 1~60(Sec), 1~60(Min) | | 30 Sec |
| ③ P/T Setting | ① Pan/Tilt Limit | ① Pan Limit | ① Position | | |
| | | | ② On/Off | Off | |
| | | ② Tilt Limit | ① Position | | |
| | | | ② On/Off | Off | |
| | ② Area Setting | Area1~8 | ① Name/② Position/③ On/Off | | Off |
| | ③ Area Masking | Mask1~8 | ① Position/② On/Off | | Off |
| | ④ Prop,P/T | On/Off | | | On |
| | ⑤ Digital Flip | On/Off | | | On |
| | ⑥ Image Hold | On/Off | | | Off |
| | ⑦ Auto Track 1 | ① Auto Track | On/Off | | Off |
| ② Camera Height | | 2.5m~30m | | 2.5 m | |
| ③ Object Size | | Small/Medium/Large | | Small | |
| ④ Sensitivity | | High/Medium/Low | | High | |
| ⑤ Zoom Control | | Off/One Shot/Continuous | | Off | |
| ⑥ Auto Release | | Off/10sec~5min | | Off | |
| ⑦ Auto Return | | Off/1sec~5min | | Off | |
| ⑧ Lost Mode | | Stop/Research/Zoom Out | | Stop | |
| ⑧ Auto Track 2 | ① Zone Setting | Zone1~8 | ① Position | | |
| | | | ② Mode(Alarm/Mask) | Mask | |
| | | | ③ On/Off | Off | |
| | ② Indicator | Off/On/Pointer/Target | | Off | |
| | ③ Target Lock | On/Off | | Off | |
| ① Camera ID | On/Off | | | On | |
| ② Camera Name | ① On/Off | | | Off | |
| | ② Edit | | | | |
| ③ Preset Number | On/Off | | | On | |

| | | | | |
|-----------------|-----------------------|---|--|-----|
| ④ OSD Setting | ④ Preset Name | ① On/Off | | |
| | | ② Edit | Off | |
| | ⑤ Sequence Status | On/Off | On | |
| | ⑥ Area Name | On/Off | Off | |
| | ⑦ PTZ Position | On/Off | On | |
| | ⑧ Language | English/Chinese/Français/Deutsch/Español/Italiano | English | |
| ⑤ Alarm Setting | ① Alarm Enable | On/Off | Off | |
| | ② Alarm Input | ① In1 | MOD:NC/NO/OFF | Off |
| | | ② In2 | Priority:1~4 | |
| | | ③ In3 | SEQ:Preset/Swing/Group/Tour/A, Pan/Trace/Off | |
| | | ④ In4 | | |
| | ③ Alarm Output | Out1~2 | 1~4, MD, TRK | |
| Time1~2 | | Off/On/Momentary | Off | |
| ④ Aux. Output | ① On/Off | On/Off | Off | |
| | ② Time | 1~60(Sec), 1~60(Min) | | |
| ⑥ Initialize | ① Power On Reset | Cancel/Execute | | |
| | ② Factory Default Set | Cancel/Execute | | |
| | ③ Camera Default Set | Cancel/Execute | | |
| | ④ Auto Refresh | Off, 1~7Days | Off | |
| | ⑤ Auto Track Default | Cancel/Execute | | |
| ⑦ Status | | | | |

Camera Setting

1. Focus and Zoom Settings

1.1 Focus Mode and Digital Zoom Setting Menu

▶ Main Menu/Camera Setting/Focus & Zoom

| | |
|-----------|------------------|
| Main Menu | |
| ① | Camera Setting |
| ② | Sequence Setting |
| ③ | P/T Setting |
| ④ | OSD Setting |
| ⑤ | Alarm Setting |
| ⑥ | Initialize |
| ⑦ | Status |

Focus Mode :

- Auto : Performs continuous auto-focus.
- Manual : Changes the camera mode to Manual Focus.
- One Shot AF : Auto-focuses the camera once after the Pan, Tilt, or Zoom function is used.

Digital Zoom :

- Enables the maximum digital zoom.
- Setting the digital zoom to 12X provides a total zoom of 444x (SPD-3700T/3700)/396x (SPD-3310)/324x (SPD-2700).

| | |
|----------------|-------------------------------|
| Camera Setting | |
| ① | Focus & Zoom |
| ② | White Balance ATW |
| ③ | Exposure |
| ④ | Back Light |
| ⑤ | AGC Medium |
| ⑥ | SSNR Medium |
| ⑦ | Day & Night |
| ⑧ | Others |

| | |
|--------------|---------------------------|
| Focus & Zoom | |
| ① | Focus Mode ONE SHOT AF |
| ② | Zoom Tracking |
| ③ | Digital Zoom OFF |

Notes

- Unlike the optical zoom, the graphics quality of the digital zoom decreases as its zoom power increases.
- The auto-focus function may not operate normally under the following conditions :
 - When background illumination is low
 - While Slow-Shutter is in operation
 - If the zoom level is set too high
 - When background illumination is too high
 - If a long distance object and a close distance object appear together within a monitoring area
 - If there is no contrast, e.g. the sky or a wall
 - If the camera is facing a thin horizontal line
- Auto Focus focuses on an object in the center of the screen; objects around the screen edges may not be properly in focus.

Functional Description

1.2 Zoom Tracking

▶ Main Menu/Camera Setting/Focus & Zoom/Zoom Tracking

| | |
|-----------|------------------|
| Main Menu | |
| ① | Camera Setting |
| ② | Sequence Setting |
| ③ | P/T Setting |
| ④ | OSD Setting |
| ⑤ | Alarm Setting |
| ⑥ | Initialize |
| ⑦ | Status |

Through this menu you can set up the camera's focus mode when zooming.

- **Mode :**
 - Auto : Auto-focuses when zooming.
 - Tracking : Focuses manually when zooming.
 - Off : Disable the focus modes when zooming. (Full manual mode)
- **Speed :**
 - Slow/Fast : Adjusts the zooming speed.

| | |
|----------------|---------------------------|
| Camera Setting | |
| ① | Focus & Zoom |
| ② | White Balance ATW |
| ③ | Exposure |
| ④ | Back Light |
| ⑤ | AGC Medium |
| ⑥ | SSNR Medium |
| ⑦ | Day & Night |
| ⑧ | Others |

| | |
|--------------|---------------------------|
| Focus & Zoom | |
| ① | Focus Mode ONE SHOT AF |
| ② | Zoom Tracking |
| ③ | Digital Zoom OFF |

| | |
|---------------|-----------------------|
| Zoom Tracking | |
| ① | Mode AUTO |
| ② | Speed FAST |

Functional Description

2. White Balance

▶ Main Menu/Camera Setting/White Balance

| | |
|-----------|------------------|
| Main Menu | |
| ① | Camera Setting |
| ② | Sequence Setting |
| ③ | P/T Setting |
| ④ | OSD Setting |
| ⑤ | Alarm Setting |
| ⑥ | Initialize |
| ⑦ | Status |

The White Balance menu adjusts the balance of the screen colors under different lighting conditions.

- ATW : Adjusts the screen color automatically.
- Indoor : Adjusts the screen color to be optimal in an indoor environment.
- Outdoor : Adjusts the screen color to be optimal in an outdoor environment.
- AWC : Adjusts the screen color to be optimized to the current lighting and monitor conditions. Using this setting may require an readjustment if the lighting conditions changes.
- MANUAL : Enables customization the Red and Blue gains.

| | |
|----------------|---------------------------|
| Camera Setting | |
| ① | Focus & Zoom |
| ② | White Balance ATW |
| ③ | Exposure |
| ④ | Back Light OFF |
| ⑤ | AGC Medium |
| ⑥ | SSNR Medium |
| ⑦ | Day & Night |
| ⑧ | Others |

Notes

White Balance may not work properly under the following conditions.

- ① When the color temperature of the environment surrounding the subject is out of the control range.(e.g. Clear sky or sunset)
- ② When the ambient illumination of the subject is dim.
- ③ If the camera is directed towards a fluorescent light or is installed in a place where illumination changes dramatically, White Balance adjustments may not deliver consistent results.

3. Exposure

▶ Main Menu/Camera Setting/Exposure

| | |
|--------------------|--|
| Main Menu | |
| ① Camera Setting | |
| ② Sequence Setting | |
| ③ P/T Setting | |
| ④ OSD Setting | |
| ⑤ Alarm Setting | |
| ⑥ Initialize | |
| ⑦ Status | |



| | |
|-----------------|--------|
| Camera Setting | |
| ① Focus & Zoom | |
| ② White Balance | ATW |
| ③ Exposure | |
| ④ Back Light | OFF |
| ⑤ AGC | Medium |
| ⑥ SSNR | Medium |
| ⑦ Day & Night | |
| ⑧ Others | |



| | |
|--------------|------|
| Exposure | |
| ① Brightness | 050 |
| ② Iris | AUTO |
| ③ Shutter | --- |
| ④ Sens-Up | AUTO |

The Exposure settings are to control the camera's exposure meter.

- **Brightness** : Adjusts the screen brightness.
(Over 50: Brighter, Under 50: Darker)
- **Iris** :
 - Auto : Automatically adjusts the exposure meter.
 - Manual : Enables manual adjustment of the exposure meter. (Over 50: Brighter, Under 50: Darker)
- **Shutter** : Controls the camera's electronic shutter.
 - --- : The shutter speed is fixed at 1/60 for NTSC and 1/50 for PAL. Operates when Iris is on the Auto Mode.
 - ESC : Adjusts the shutter speed automatically according to the screen brightness. Operates when Iris is on the Manual Mode.
 - A.FLK : Select this setting when you experience picture flickering. Flickering can happen when artificial lighting frequencies clash with camera frame rates.
 - Manual : Enables manual adjustment of the shutter speed.
- **Sens-Up** :
 - Auto : Automatically detects light levels and maintains a clear picture at night or under low-light conditions.
 - Sens-Up Limit : Adjusts to the maximum-powered zoom per frame.

Notes

- For optimal performance of the A.FLK mode, avoid using the mode in conjunction with Backlight.
- While the Internal Sync mode is in effect, setting the shutter to '---' and facing the camera directly to a bright light source may cause poor camera performance.
- Sens-Up is disabled when the shutter is in Manual or A. FLK mode.

4. Backlight

4.1 Backlight Mode Settings

▶ Main Menu/Camera Setting/Back Light

| | |
|--------------------|--|
| Main Menu | |
| ① Camera Setting | |
| ② Sequence Setting | |
| ③ P/T Setting | |
| ④ OSD Setting | |
| ⑤ Alarm Setting | |
| ⑥ Initialize | |
| ⑦ Status | |



| | |
|-----------------|--------|
| Camera Setting | |
| ① Focus & Zoom | |
| ② White Balance | ATW |
| ③ Exposure | |
| ④ Back Light | OFF |
| ⑤ AGC | Medium |
| ⑥ SSNR | Medium |
| ⑦ Day & Night | |
| ⑧ Others | |

Unlike other cameras, Samsung Techwin's unique SV-IV DSP chip gives you a clear image of the subject even with bright backlight.

- **Back Light Mode** :
 - Off : Disables the Backlight mode.
 - HLC : Activates the High Light Compensation mode.
 - User : Activates a user defined backlight compensation mode.

Functional Description

4.2 HLC

▶ Main Menu/Camera Setting/Back Light/HLC

| Main Menu | |
|-----------|------------------|
| ① | Camera Setting |
| ② | Sequence Setting |
| ③ | P/T Setting |
| ④ | OSD Setting |
| ⑤ | Alarm Setting |
| ⑥ | Initialize |
| ⑦ | Status |

The HLC settings selectively eliminates high lights in a limited environment such as the entrance to an apartment parking lot or gas station, and is useful to detect a small objects like car license plates.

HLC is disabled during the daytime. While monitoring nighttime car traffic, if car headlamps reflect too bright lights on the screen, the camera automatically eliminates the headlamp lights and adjusts the colors of the license plate accordingly.

| Camera Setting | |
|----------------|-------------------|
| ① | Focus & Zoom |
| ② | White Balance ATW |
| ③ | Exposure |
| ④ | Back Light HLC |
| ⑤ | AGC Medium |
| ⑥ | SSNR Medium |
| ⑦ | Day & Night |
| ⑧ | Others |

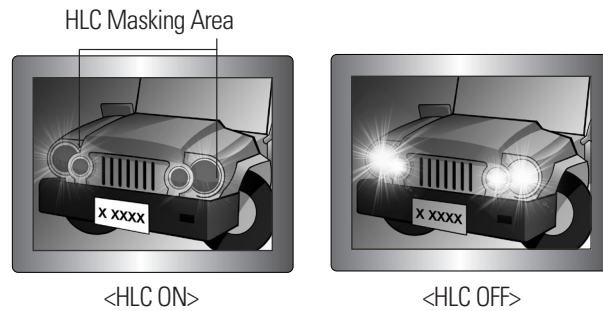

| HLC Setting | |
|-------------|---------------|
| ① | Limit Medium |
| ② | Mask Color 05 |

- **Limit :**
Adjusts the HLC sensitivity level.
- **Mask Color :**
Adjusts the mask color on the highlighted area.

Notes

- Even if HLC is on, car license plates may not be detectable depending on the location and angle of the camera as well as the lighting condition.

Functional Description

4.3 User Area Setting

▶ Main Menu/Camera Setting/Back Light/User

| Main Menu | |
|-----------|------------------|
| ① | Camera Setting |
| ② | Sequence Setting |
| ③ | P/T Setting |
| ④ | OSD Setting |
| ⑤ | Alarm Setting |
| ⑥ | Initialize |
| ⑦ | Status |

You can selectively choose a screen area to see objects within the area more clearly than others.

- **Four-direction Joystick Controls :**
 - Moving the joystick in all four directions—upward, downward, left, and right—adjusts the location and size of a selected area.
- **Zoom Control :**
 - Zoom Tele : Enlarges the size of a selected area.
 - Zoom Wide : Reduces the size of a selected area.

| Camera Setting | |
|----------------|-------------------|
| ① | Focus & Zoom |
| ② | White Balance ATW |
| ③ | Exposure |
| ④ | Back Light USER |
| ⑤ | AGC Medium |
| ⑥ | SSNR Medium |
| ⑦ | Day & Night |
| ⑧ | Others |

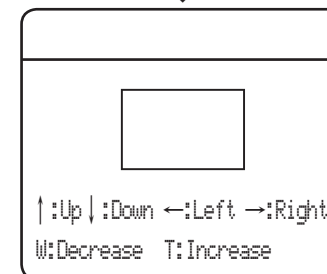

Functional Description

5. AGC

- ▶ Main Menu/Camera Setting/AGC

| Main Menu | |
|-----------|------------------|
| ① | Camera Setting |
| ② | Sequence Setting |
| ③ | P/T Setting |
| ④ | OSD Setting |
| ⑤ | Alarm Setting |
| ⑥ | Initialize |
| ⑦ | Status |



| Camera Setting | |
|----------------|----------------------------|
| ① | Focus & Zoom |
| ② | White Balance ATW |
| ③ | Exposure |
| ④ | Back Light OFF |
| ⑤ | AGC Medium |
| ⑥ | SSNR Medium |
| ⑦ | Day & Night |
| ⑧ | Others |

AGC (Automatic Gain Control) adjusts the camera's gain control and the screen brightness if the camera has captured an object under low-light conditions. The Off, Low, Medium, High, and Manual modes are available.

Functional Description

6. SSNR (Samsung Super Noise Reduction)

- ▶ Main Menu/Camera Setting/SSNR

| Main Menu | |
|-----------|------------------|
| ① | Camera Setting |
| ② | Sequence Setting |
| ③ | P/T Setting |
| ④ | OSD Setting |
| ⑤ | Alarm Setting |
| ⑥ | Initialize |
| ⑦ | Status |



| Camera Setting | |
|----------------|----------------------------|
| ① | Focus & Zoom |
| ② | White Balance ATW |
| ③ | Exposure |
| ④ | Back Light OFF |
| ⑤ | AGC Medium |
| ⑥ | SSNR Medium |
| ⑦ | Day & Night |
| ⑧ | Others |

SSNR significantly reduces the amount of low luminance noise.

- Off : Disables the noise reduction function.
- Low : Reduces only a small amount of noise, but generates almost no afterimage.
- Medium : The most commonly used mode. Reduces a suitable amount of noise while generating a subtle afterimage.
- High : Reduces noise significantly, but generates obvious afterimages.



Notes

- SSNR is disabled when the AGC mode is turned off.

Functional Description

7. Day & Night

► Main Menu/Camera Setting/Day & Night

| | |
|--------------------|--|
| Main Menu | |
| ① Camera Setting | |
| ② Sequence Setting | |
| ③ P/T Setting | |
| ④ OSD Setting | |
| ⑤ Alarm Setting | |
| ⑥ Initialize | |
| ⑦ Status | |

| | |
|-----------------|--------|
| Camera Setting | |
| ① Focus & Zoom | |
| ② White Balance | ATW |
| ③ Exposure | |
| ④ Back Light | OFF |
| ⑤ AGC | Medium |
| ⑥ SSNR | Medium |
| ⑦ Day & Night | |
| ⑧ Others | |

| | |
|--------------|---------|
| Day & Night | |
| ① Mode | COLOR |
| ② Duration | FAST |
| ③ Dwell Time | 0.5 SEC |

The Day & Night function allows the camera to switch between the Color and B/W modes.

Modes :

- Auto : Operates in Color mode most times, and switches to B/W mode if a low light level is detected during nighttime.
- Color : Operates in Color mode at all times.
- B/W : Operates in B/W mode at all times. By using the Burst On/Off sub menu, burst signals can be retained or disabled.

* If the camera is in B/W mode and connected to equipment that requires external sync through burst signals, set the Burst On/Off option to "On."

Duration :

The camera's light sensitivity is adjustable as in the chart below. The camera's ambient light diversion performance may vary depending on its environment.

| | Color → B/W | B/W → Color |
|------|-------------|-------------|
| Fast | 2,5 Lux | 4 Lux |
| Slow | 0,8 Lux | 6 Lux |

Dwell Time :

The duration of both the lighting conditions can be customized to let the camera divert between the daytime and nighttime settings.

Notes

- The Auto mode is disabled when AGC is turned off. This function is only available when the Color or B/W mode is selected.
- Using B/W mode under sunlight or a halogen lamp may decrease the focusing performance.

Functional Description

8. Others

► Main Menu/Camera Setting/Others

| | |
|--------------------|--|
| Main Menu | |
| ① Camera Setting | |
| ② Sequence Setting | |
| ③ P/T Setting | |
| ④ OSD Setting | |
| ⑤ Alarm Setting | |
| ⑥ Initialize | |
| ⑦ Status | |

| | |
|-----------------|--------|
| Camera Setting | |
| ① Focus & Zoom | |
| ② White Balance | ATW |
| ③ Exposure | |
| ④ Back Light | OFF |
| ⑤ AGC | Medium |
| ⑥ SSNR | Medium |
| ⑦ Day & Night | |
| ⑧ Others | |

| | |
|--------------|----------|
| Others | |
| ① Sync | INTERNAL |
| ② Stabilizer | OFF |
| ③ Image Adj | |
| ④ Freeze | OFF |
| ⑤ Dome Cover | Inner |

- **Sync** : Enables selecting Internal Synchronization or the external Line Lock. (SPD-3700T not supported)
 - Internal : Synchronizes the camera's output timing to the internal crystal.
 - Line Lock : Synchronizes the camera's output timing to the AC adapter power to synchronize multiple cameras. This option is useful when using a switch such as Matrix Switcher.
 - Line Lock Phase : Enables setting the adapter's synchronization phase between 0 and 360°.
- **Stabilizer** : The Stabilizer compensates for any small movements of the camera caused by due to the wind and other reasons or other causes.

Notes

- The Stabilizer uses the digital zoom and may cause low picture quality.
- The Stabilizer is disabled if the ambient light is too low.
- The Stabilizer is disabled if the field of view has very low or no contrast, e.g. The sky or a white wall.

Image Adj :

- Sharpness : Sharpens outlines of an image.
- Color : Adjusts the color density of an image.

Freeze :

Stops or reanimates an image.

Dome Cover :

- These settings are to optimize the camera's focused object position according to the dome cover type.
- Inner : Default dome cover type including the indoor flush model. (Factory Release Mode)
 - Outer : Dome cover type for outdoor housings except the indoor flush model.
 - None : When using the camera without a dome cover.

Sequence Setting

9. Power On Resume and MD Dwell Time

▶ Main Menu/Sequence Setting

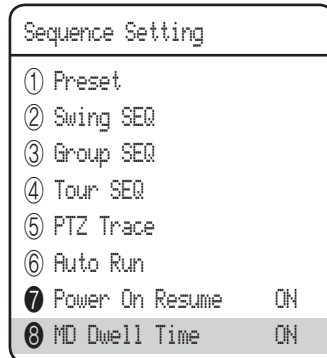
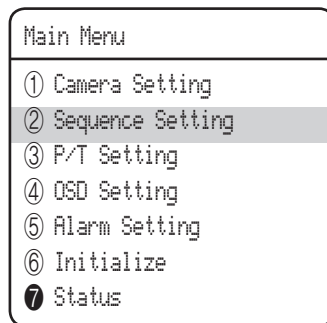

Power On Resume :

This is useful when the power is disconnected and reconnected due to power failures or other power interruptions.

If the camera was performing a sequence action prior to a power disconnection, the camera automatically resumes the action when the power is reconnected.

MD Dwell Time :

When Motion Detection under the Preset Edit menu is selected, MD Dwell Time performs the Tour or Group function.

While the camera is performing a sequence action, if motion is detected from a selected preset location, the camera pauses the sequence action operation and starts monitoring the location instead for a duration that is set under the MD Dwell Time menu.

If the motion is no longer detectable or the duration expires, the camera aborts the monitoring operation and then resumes the sequence action.

10. Preset

10.1 Preset Location Saving

▶ Main Menu/Sequence Setting/Preset/Setting

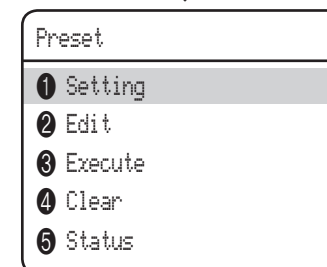
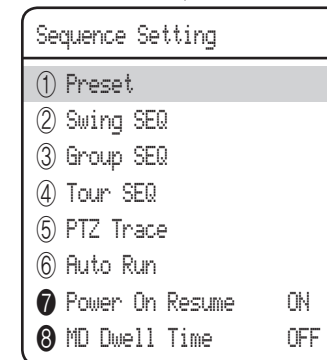
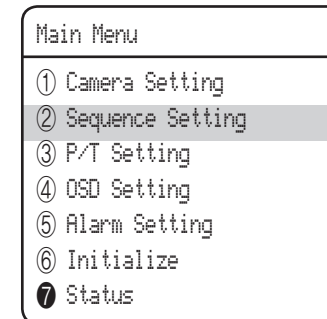

This function enables the memorization of a selected location and activates the Pan, Tilt, and Zoom functions at that location. Saved locations can be recalled using the Preset Execute command.

Setting Up Preset Numbers :

Selecting the Preset Setting menu brings up a screen as shown below. Move the joystick in all four directions to select the desired number.

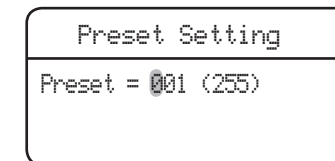

Saving Preset Locations :

Selecting a preset number and pressing the Enter key redirects the menu to the screen shown below. Using the joystick, adjust the location of the Pan and Tilt functions and then set the Zoom and Focus command. In Preset Settings, the Zoom and Focus command is controllable only by the Zoom command. To switch between Zoom and Focus, use the Preset 1 and 2 commands as shown below.

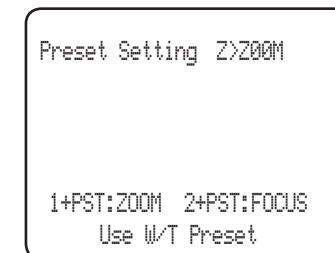

Functional Description

10.4 Preset Execution/Deletion/Memory Check

▶ Main Menu/Sequence Setting/Preset

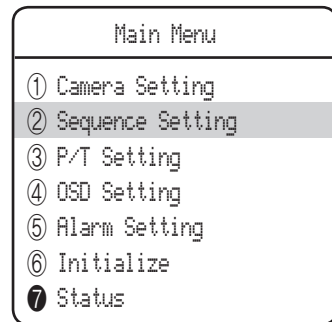

- **Home Position :**
Sets one of the currently configured preset positions as the home position.
- **Execute :**
Recalls a saved preset location.
- **Clear :**
Deletes the selected preset location.
- **Status :**
Opens a map of saved preset locations.
An area saved as a preset location is displayed with the '■' icon.

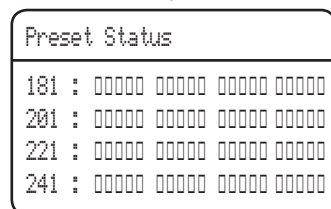
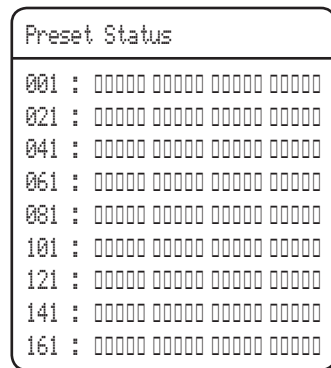
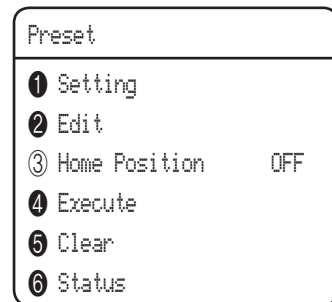
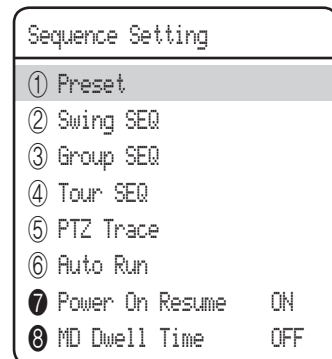

Functional Description

11. Swing SEQ

▶ Main Menu/Sequence Setting/Swing SEQ

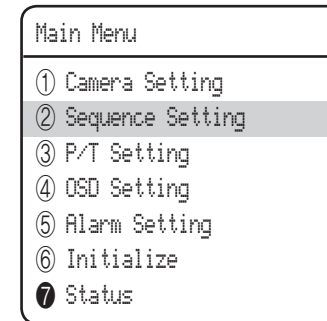

The Swing function commands the camera to move between 2 selected locations, monitoring the route.

- **Pan Swing :**
Activates the Pan function for the Swing operation.
- **Tilt Swing :**
Activates the Tilt function for the Swing operation.
- **P&T Swing :**
Activates both the Pan and Tilt functions for the Swing operation.
- **Swing Settings/Execute/Clear :**
- Settings : Each of the Swing menus have sub menus with the settings.

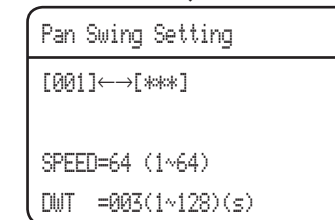
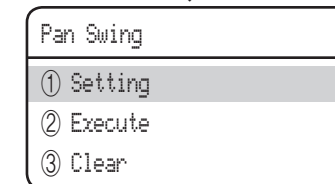
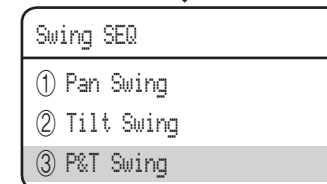
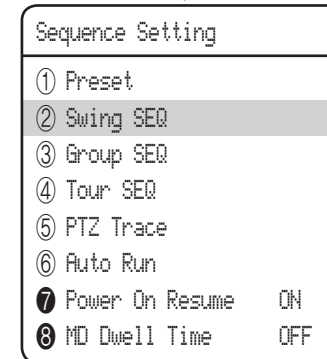

- Select 2 preset locations by using the joystick.
- Speed indicates the camera's movement speed. DWT indicates the camera's duration of stay at a preset location.
- Execute: Executes the Swing operation.
- Clear: Deletes data in the Swing memory.

12. Group SEQ

▶ Main Menu/Sequence Setting/Group SEQ

| | |
|--------------------|--|
| Main Menu | |
| ① Camera Setting | |
| ② Sequence Setting | |
| ③ P/T Setting | |
| ④ OSD Setting | |
| ⑤ Alarm Setting | |
| ⑥ Initialize | |
| ⑦ Status | |

Selecting Group SEQ recalls a group of multiple preset locations in a consecutive manner. A group can contain up to 255 preset locations.

Setting :

Using the joystick, enter desired preset numbers into the PSET section. DWT indicates the camera's duration of stay at a preset location. SPD shows the camera's movement speed by 64 different levels.

| | |
|-------------------|-----|
| Sequence Setting | |
| ① Preset | |
| ② Swing SEQ | |
| ③ Group SEQ | |
| ④ Tour SEQ | |
| ⑤ PTZ Trace | |
| ⑥ Auto Run | |
| ⑦ Power On Resume | ON |
| ⑧ MD Dwell Time | OFF |

| Group SEQ 1 | | | |
|-------------|-------|--------|-----|
| NO | PSET | DWT(s) | SPD |
| 001: | *** : | 003 : | 64 |
| 002: | *** : | 003 : | 64 |
| 003: | *** : | 003 : | 64 |
| 004: | *** : | 003 : | 64 |
| 005: | *** : | 003 : | 64 |
| 006: | *** : | 003 : | 64 |
| 007: | *** : | 003 : | 64 |

| | |
|-----------|--|
| Group SEQ | |
| ① Group 1 | |
| ② Group 2 | |
| ③ Group 3 | |
| ④ Group 4 | |
| | |

Execute :

Executes the group operation.

Clear :

Deletes the selected group.

| | |
|-------------|--|
| Group SEQ 1 | |
| ① Setting | |
| ② Execute | |
| ③ Clear | |

13. Tour SEQ

▶ Main Menu/Sequence Setting/Tour SEQ

| | |
|--------------------|--|
| Main Menu | |
| ① Camera Setting | |
| ② Sequence Setting | |
| ③ P/T Setting | |
| ④ OSD Setting | |
| ⑤ Alarm Setting | |
| ⑥ Initialize | |
| ⑦ Status | |

Selecting Tour SEQ recalls groups of preset locations in a consecutive manner. Up to 6 groups can be listed for this function.

Settings :

Selecting the Settings menu brings up the following screen. Using the joystick, you can enter desired group numbers to the Group section. DWT indicates the camera's standby time before a new group is recalled.

| | |
|-------------------|-----|
| Sequence Setting | |
| ① Preset | |
| ② Swing SEQ | |
| ③ Group SEQ | |
| ④ Tour SEQ | |
| ⑤ PTZ Trace | |
| ⑥ Auto Run | |
| ⑦ Power On Resume | ON |
| ⑧ MD Dwell Time | OFF |

| Tour SEQ | | |
|----------|-------|--------|
| NO | Group | DWT(s) |
| 01: | * | 003 |
| 02: | * | 003 |
| 03: | * | 003 |
| 04: | * | 003 |
| 05: | * | 003 |
| 06: | * | 003 |

| | |
|-----------|--|
| Tour SEQ | |
| ① Setting | |
| ② Execute | |
| ③ Clear | |

Execute :

Executes the group operation.

Clear :

Deletes the selected group.

14. PTZ Trace

▶ Main Menu/Sequence Setting/PTZ Trace

| | |
|--------------------|--|
| Main Menu | |
| ① Camera Setting | |
| ② Sequence Setting | |
| ③ P/T Setting | |
| ④ OSD Setting | |
| ⑤ Alarm Setting | |
| ⑥ Initialize | |
| ⑦ Status | |

| | |
|-------------------|-----|
| Sequence Setting | |
| ① Preset | |
| ② Swing SEQ | |
| ③ Group SEQ | |
| ④ Tour SEQ | |
| ⑤ PTZ Trace | |
| ⑥ Auto Run | |
| ⑦ Power On Resume | ON |
| ⑧ MD Dwell Time | OFF |

| | |
|-----------|--|
| PTZ Trace | |
| ① Trace 1 | |
| ② Trace 2 | |
| ③ Trace 3 | |
| ④ Trace 4 | |

| | |
|-------------|--|
| PTZ Trace 1 | |
| ① Replay | |
| ② Memorize | |

Maximum 4 patterns of the manual operation paths (for Pan, Tilt, Zoom and Focus) are memorized and replayed.

▶ Replay :

Replays a route saved by the Trace function. Use the Stop button to stop the replay.

▶ Memorize :

Up to 120 seconds of a memory can be saved. The memory duration varies depending on the difficulty level of the PTZ Trace action. If the memory capacity is full, the Over message appears and the memorization action is terminated.

15. Auto Run

▶ Main Menu/Sequence Setting/Auto Run

| | |
|--------------------|--|
| Main Menu | |
| ① Camera Setting | |
| ② Sequence Setting | |
| ③ P/T Setting | |
| ④ OSD Setting | |
| ⑤ Alarm Setting | |
| ⑥ Initialize | |
| ⑦ Status | |

| | |
|-------------------|-----|
| Sequence Setting | |
| ① Preset | |
| ② Swing SEQ | |
| ③ Group SEQ | |
| ④ Tour SEQ | |
| ⑤ PTZ Trace | |
| ⑥ Auto Run | |
| ⑦ Power On Resume | ON |
| ⑧ MD Dwell Time | OFF |

| | |
|----------|--------|
| Auto Run | |
| ① Mode | OFF |
| ② Time | 30 SEC |

If there is no controller operation by the user for a certain time, the sequence operation designated by the user will be executed.

▶ Mode :

- Home : Auto run Home Position (Refet to the Preset Menu.)

- Preset : Auto run a selected preset number.

- Swing : Auto run a selected Swing mode.

- Group : Auto run a selected Group mode.

- Tour : Auto run a selected Tour mode.

- Trace : Auto run a selected trace mode.

- A.Pan : Auto run a 360-degree pan. To activate the panning command, you need to set up the camera's tilt angle and auto pan speed manually.

▶ Time :

Enables setting up an Auto Run duration. (The duration can be 1~60 seconds, or 1~60 minutes.)

P/T Setting

16. Pan/Tilt Limit

▶ Main Menu/P/T Setting/Pan/Tilt Limit

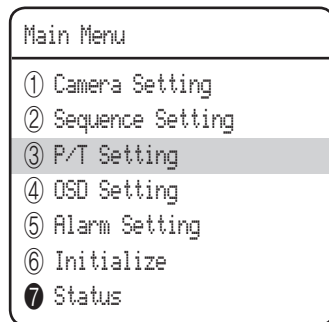

The moving ranges in the Pan/Tilt directions can be limited.

Position :

Selecting the Position menu brings up the following screen if it is for the Pan Limit setting. Move the joystick left and right to select a movement range from the starting point to the end.

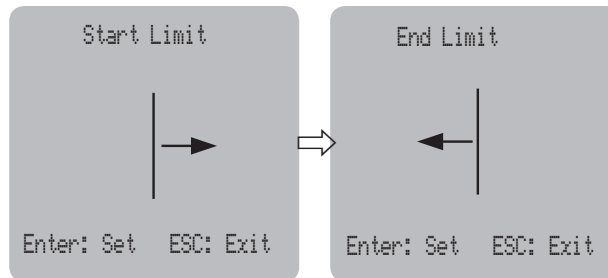

The following picture shows the Tilt Limit setting. Move the joystick left and right to select a movement range from the starting point to the end.

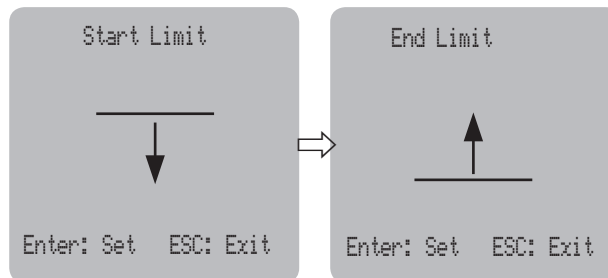

On/Off :

Cancels or activates the Pan/Tilt Limit functions.

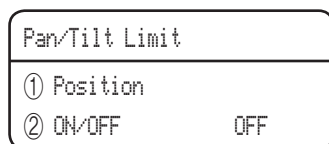
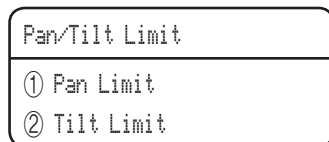
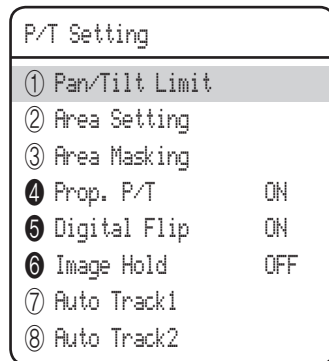

17. Area Setting

▶ Main Menu/P/T Setting/Area Setting

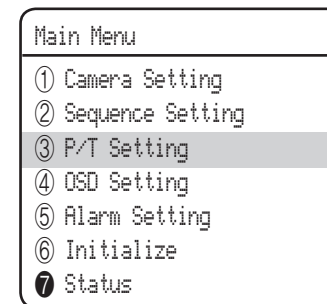

The Area Setting menu enables selecting certain locations in the course of the Pan and Tilt operation, and then display the areas with the OSD (On Screen Display) texts when the camera passes through them. Up to 8 areas can be selected.

Area Name :

You can add names to selected areas. Names can be up to 12 characters and can be entered via the joystick and the Enter key. Once a name is entered, use the joystick and the Enter key to perform the Set command and save the name.

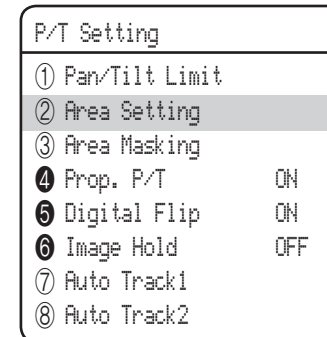
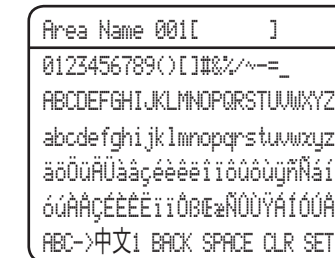

Position :

As shown in the picture below, move the joystick to select the upper left corner and lower right corner of an area.

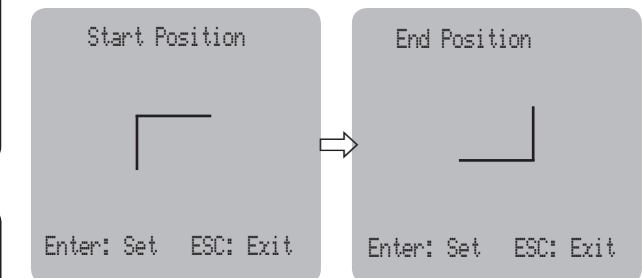

On/Off :

Cancels or activates the display function of selected areas.

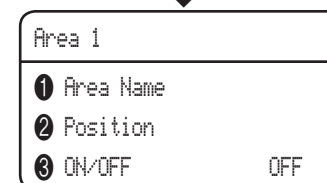
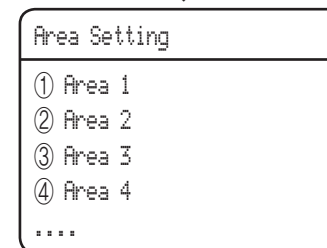

18. Area Masking

► Main Menu/P/T Setting/Area Masking

| Main Menu | |
|--------------------|--|
| ① Camera Setting | |
| ② Sequence Setting | |
| ③ P/T Setting | |
| ④ OSD Setting | |
| ⑤ Alarm Setting | |
| ⑥ Initialize | |
| ⑦ Status | |

If a monitoring location includes a highly private area, the area can be selectively excluded from monitoring.

► Position :

As shown in the picture below, move the joystick to select the upper left corner and lower right corner of an area.

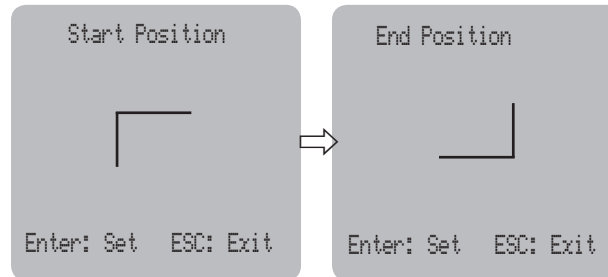

► On/Off :

Cancels or activates the Area Masking function.

| P/T Setting | |
|----------------------|--|
| ① Pan/Tilt Limit | |
| ② Area Setting | |
| ③ Area Masking | |
| ④ Prop. P/T ON | |
| ⑤ Digital Flip ON | |
| ⑥ Image Hold OFF | |
| ⑦ Auto Track1 | |
| ⑧ Auto Track2 | |

| Area Setting | |
|--------------|--|
| ① Mask 1 | |
| ② Mask 1 | |
| ③ Mask 3 | |
| ④ Mask 4 | |
| | |

| Mask 1 | |
|-------------------|--|
| ① Position | |
| ② ON/OFF OFF | |

19. Prop. P/T

► Main Menu/P/T Setting/Prop. P&T

| Main Menu | |
|--------------------|--|
| ① Camera Setting | |
| ② Sequence Setting | |
| ③ P/T Setting | |
| ④ OSD Setting | |
| ⑤ Alarm Setting | |
| ⑥ Initialize | |
| ⑦ Status | |

This commands the camera to change the Pan and Tilt speed automatically according to the current zoom power. Moving the joystick clockwise (Tele) slows down and counterclockwise (Wide) accelerates the Pan and Tilt speed, allowing detailed adjustments.

Turning this "Off" executes the function the optical 1x zoom speed regardless of how high a the zoom power is.

| P/T Setting | |
|----------------------|--|
| ① Pan/Tilt Limit | |
| ② Area Setting | |
| ③ Area Masking | |
| ④ Prop. P/T ON | |
| ⑤ Digital Flip ON | |
| ⑥ Image Hold OFF | |
| ⑦ Auto Track1 | |
| ⑧ Auto Track2 | |

Functional Description

20. Digital Flip

▶ Main Menu/P/T Setting/Digital Flip

| Main Menu | |
|--------------------|--|
| ① Camera Setting | |
| ② Sequence Setting | |
| ③ P/T Setting | |
| ④ OSD Setting | |
| ⑤ Alarm Setting | |
| ⑥ Initialize | |
| ⑦ Status | |



| P/T Setting | |
|------------------|-----|
| ① Pan/Tilt Limit | |
| ② Area Setting | |
| ③ Area Masking | |
| ④ Prop. P/T | ON |
| ⑤ Digital Flip | ON |
| ⑥ Image Hold | OFF |
| ⑦ Auto Track1 | |
| ⑧ Auto Track2 | |

Digital Flip is useful to monitor a moving object or a person passing directly under the camera.
When an object or a person passes directly under the camera, the camera tilt monitor follows the object or person over 100 degrees to the other side of the tilt area without panning. The screen inversion occurs at 100 degrees or higher and is digitally adjusted.

Functional Description

21. Image Holding

▶ Main Menu/P/T Setting/Image Hold

| Main Menu | |
|--------------------|--|
| ① Camera Setting | |
| ② Sequence Setting | |
| ③ P/T Setting | |
| ④ OSD Setting | |
| ⑤ Alarm Setting | |
| ⑥ Initialize | |
| ⑦ Status | |



| P/T Setting | |
|------------------|-----|
| ① Pan/Tilt Limit | |
| ② Area Setting | |
| ③ Area Masking | |
| ④ Prop. P/T | ON |
| ⑤ Digital Flip | ON |
| ⑥ Image Hold | OFF |
| ⑦ Auto Track1 | |
| ⑧ Auto Track2 | |

When the camera is moving between preset locations, this function stops a previous camera feed until the camera reaches the next location. This is useful to help the screen observer keep sharp eyes and to monitor multiple locations within a network.

22. Auto Track 1 (SPD-3700T Only)

▶ Main Menu/P/T Setting/Auto Track1

| Main Menu | |
|-----------|------------------|
| ① | Camera Setting |
| ② | Sequence Setting |
| ③ | P/T Setting |
| ④ | OSD Setting |
| ⑤ | Alarm Setting |
| ⑥ | Initialize |
| ⑦ | Status |



| P/T Setting | | |
|-------------|----------------|-----|
| ① | Pan/Tilt Limit | |
| ② | Area Setting | |
| ③ | Area Masking | |
| ④ | Prop. P/T | ON |
| ⑤ | Digital Flip | ON |
| ⑥ | Image Hold | OFF |
| ⑦ | Auto Track1 | |
| ⑧ | Auto Track2 | |



| Auto Track 1 | | |
|--------------|---------------|-------|
| ① | Auto Track | OFF |
| ② | Camera Height | 02.5M |
| ③ | Object Size | SMALL |
| ④ | Sensitivity | HIGH |
| ⑤ | Zoom Control | OFF |
| ⑥ | Auto Release | OFF |
| ⑦ | Auto Return | OFF |
| ⑧ | Lost Mode | STOP |

This function is available only with the SPD-3700T.

This commands the camera to automatically follow a moving object or a person on the screen.

- **Auto Track :**
On/Off: Turns Auto Track on or off.
- **Camera Height :**
Adjusts the height of the camera. Tracking performance may decrease if the camera height is not adjusted properly.
- **Object Size :**
Sets a maximum zoom power to zoom in on an object if the Zoom function is used for the tracking operation.
 - Small : Zooms in on a tracking object up to 1/4 of the screen height.
 - Medium : Zooms in on a tracking object up to 2/4 of the screen height.
 - Large : Zooms in on a tracking object up to 3/4 of the screen height.
- **Sensitivity :**
The object detection sensitivity is adjustable. Lower the sensitivity if the camera catches a swaying tree branch, raindrops, or snowflakes during the Auto Track operation.
- **Zoom Control :**
The function's zoom control settings are as follows.
 - Off : Disables the Zoom control.
 - One Shot : Performs the Zoom control once during the Motion Detection and Auto Track operations. Depending on the movement detection, the camera performs the Zoom control multiple times.
 - Continuous : Performs the Zoom control continuously.

- **Auto Release :**
Enables setting a maximum duration to follow an object. When the duration expires, the camera stops following the object and returns to the start position to follow another objects.
- **Auto Return :**
 - Off : Commands the camera to stay on a last spot instead of returning to the initial position.
 - Time Setting : Sets a duration for the camera to standby upon the Auto Release expiration and then return to the start position.
- **Lost Mode :**
Sets up an action for the camera in case the object it is following goes out of the detection range.
 - Stop : Commands the camera to stop and abort tracking at the spot where its object disappeared.
 - Research : Commands the camera to stop and standby at the spot where its object disappeared.
 - Zoom-Out : Commands the camera to zoom out and look for a new object in case its current object disappears.

Functional Description

23. Auto Track 2 (SPD-3700T Only)

► Main Menu/P/T Setting/Auto Track2

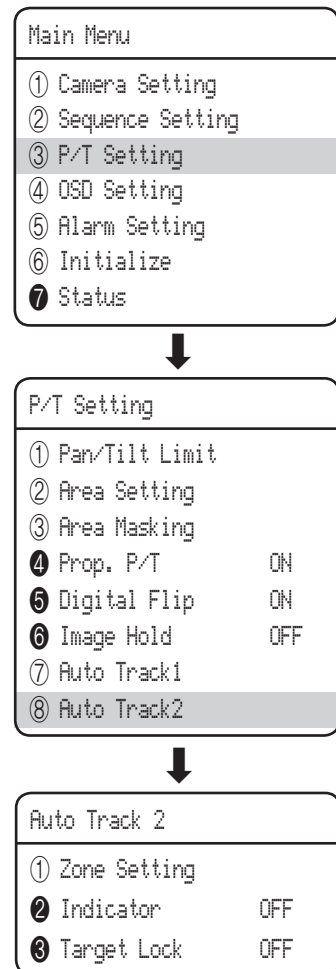

This function is available only with the SPD-3700T.

Auto Track 2 provides Auto Track related settings other than the ones programmed in the Auto Track 1 menu.

► Zone Setting :

- Position : Enables designating certain areas as zones for the Auto Track operation. The setting procedures are the same as for Area Mask.
- Mode : Two modes are available: Mask and Alarm. When Mask is selected, the camera does not follow the object entering the masked zone. This is useful if the camera catches swaying objects such as tree branches and flags during the Auto Track operation. When Alarm is selected, the camera activates an alarm if an object enters the zone.
- On/Off : Activates or deactivates the Zone function.

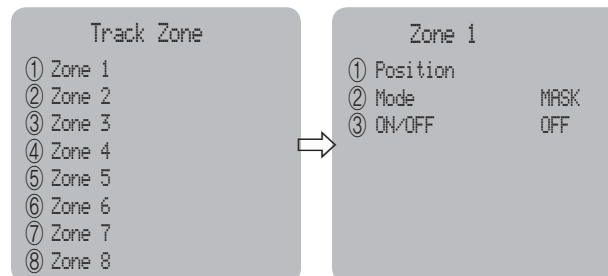

► Indicator :

- Indicates objects with icons on the screen.
- Off : Disables the Indicator function.
- On : Indicates both the pointer and target.
- Pointer : Indicates the indicator when following an object using the joystick; shows as a cross in the center of the screen.

Functional Description

- Target : Indicates the camera's target for the Auto Track operation; when a moving object is detected, a square grid appears and surrounds the object.

► Target Lock :

Target Lock is useful to select and follow an object using the Auto Track mode while operating the camera with the joystick. Target Lock can be turned On or Off. To activate the Auto Track mode, turn on Target Lock, select an object to follow, and then press Enter.

Notes

- Auto Track is specifically to track down intruders. Thus, it may not be suitable to monitor a crowd.
- If the camera is not safely secured, tracking errors may occur.
- If the camera lens is smeared with foreign substances or is scratched, an error may occur causing the camera to not behave as expected.
- The camera may not follow an object or tracking errors may occur under the following conditions:
 - If the contrast between an object and the background is low
 - If the camera lens is smeared with foreign substances, e.g. raindrops or snowflakes
 - If the lighting is changing dramatically
 - If many movements around an object are detected
 - If an object moves vertically on the optic angle of the camera
 - If an object passes directly under the camera
 - If an object creates inconsistent light levels, e.g. the object is too shiny or flickering
 - In environments where there are light reflections causing internal reflections of camera, e.g. windows, shiny road surfaces, and backlights
 - If an object moves behind large and tall objects, e.g. telephone poles
 - If an object moves too quickly
 - If the camera is vibrating

Functional Description

OSD Setting

24. OSD Setting

▶ Main Menu/OSD Setting

| Main Menu | |
|--------------------|--|
| ① Camera Setting | |
| ② Sequence Setting | |
| ③ P/T Setting | |
| ④ OSD Setting | |
| ⑤ Alarm Setting | |
| ⑥ Initialize | |
| ⑦ Status | |

| OSD Setting | |
|-------------------|---------|
| ① Camera ID | ON |
| ② Camera Name | |
| ③ Preset Number | ON |
| ④ Preset Name | ON |
| ⑤ Sequence Status | ON |
| ⑥ Area Name | OFF |
| ⑦ PTZ Position | ON |
| ⑧ Language | English |

| XXX Name | 001C |] |
|-----------------------------|------|---|
| 0123456789()[]#&%/~-=_ | | |
| ABCDEFGHIJKLMNPOQRSTUVWXYZ | | |
| abcdefghijklmnopqrstuvwxyz | | |
| aoöuAÜaäçéèëiioóouyññai | | |
| óúáâçéèëiioóe&ñóúyáíóúá | | |
| ABC->中文1 BACK SPACE CLR SET | | |

- **Camera ID :**
Displays or hides Camera ID in the upper left of the screen.
- **Camera Name :**
Add a name to the camera. (First check the Note.)
- **Preset Number :**
Displays or hides Preset Numbers on the screen.
- **Preset Name :**
Add names to preset locations. (First check the Note.)
- **Sequence Status :**
Displays or hides the status of a sequence action that is in progress.
- **Area Name :**
Displays or hides the Area Name for the Area Settings on the screen.
- **PTZ Position :**
Displays or hides the status of the Pan, Tilt, and Zoom operation that is in progress.
- **Language :**
Enables changing the system language. This camera supports English, Chinese, French, German, Spanish, and Italian.

* When selecting the Camera Name and Preset Name, the screen displays the Left keypad. Names can be up to 12 characters and can be entered via the joystick and the Enter key. Once a name is entered, use the joystick and the Enter key to perform the Set command and save the name.

Functional Description

Alarm Setting

25. Alarm Setting

25.1. Setting Up Alarm Input

▶ Main Menu/Alarm Setting/Alarm Input

| Main Menu | |
|--------------------|--|
| ① Camera Setting | |
| ② Sequence Setting | |
| ③ P/T Setting | |
| ④ OSD Setting | |
| ⑤ Alarm Setting | |
| ⑥ Initialize | |
| ⑦ Status | |

| Alarm Setting | |
|----------------|-----|
| ① Alarm Enable | OFF |
| ② Alarm Input | |
| ③ Alarm Output | |
| ④ Aux Output | |

| ALM | MOD | P | SEQ. | NO |
|-------|-----|---|------|-----|
| ① IN1 | OFF | 1 | | OFF |
| ② IN2 | OFF | 2 | | OFF |
| ③ IN3 | OFF | 3 | | OFF |
| ④ IN4 | OFF | 4 | | OFF |

- **Alarm Enable :**
- On/Off : Enables or disables the Alarm function.

- **MOD :**
Enables selecting an Alarm Input method.
- NO (Normally Open)

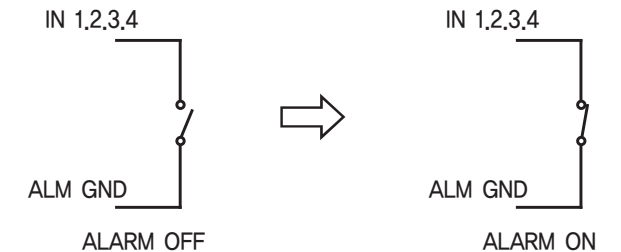

- NC (Normally Closed)

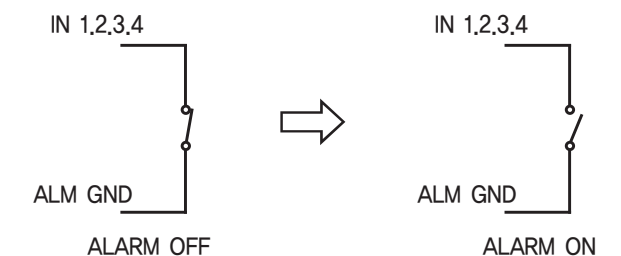

Functional Description

Notes

- As shown in the picture above, the Alarm Input must be entered with the Open and Close switch signals. Supplying power without entering the signals may damage the product.

P (Priority) :

Set the priority of Alarm Inputs. If more than one alarm is simultaneously activated, the alarm with the highest priority activates before the others. Once the alarm is canceled, the next highest priority alarm activates.

SEQ :

Enables setting up a sequence action for the camera in response to an alarm. Available sequence actions are Preset, Swing, Group, Tour, Trace and A.Pan.

Functional Description

25.2. Alarm Output

Main Menu/Alarm Setting/Alarm Output

| Main Menu | |
|--------------------|--|
| ① Camera Setting | |
| ② Sequence Setting | |
| ③ P/T Setting | |
| ④ OSD Setting | |
| ⑤ Alarm Setting | |
| ⑥ Initialize | |
| ⑦ Status | |

| Alarm Setting | |
|--------------------|--|
| ① Alarm Enable OFF | |
| ② Alarm Input | |
| ③ Alarm Output | |
| ④ Aux Output | |

| Alarm Output | |
|---------------------------------|--|
| ① Setting1 01 02 03 04 0MD 0TRK | |
| ② Setting2 01 02 03 04 0MD 0TRK | |
| ③ Timer 1 OFF | |
| ④ Timer 1 OFF | |

Setting 1,2 :

Enables selecting an Alarm Output method.

- 1, 2, 3, 4, and MD on the menu selection indicate the alarm input port and motion detection input. Up to 4 alarm inputs can be set for each MD (Motion Detection) and TRK (Auto Track). 1 alarm output port can be used for more than 2 alarm inputs along with ones for MD and TRK.

* The TRK function becomes activated only if the Zone mode under Zone Settings under Auto Track 2 is set to Alarm.

Timer :

Enables selecting an Alarm Output method.

- On : Retains an alarm output for a set duration from a minimum of 1 second to a maximum of 60 hours upon the alarm occurrence.
- Momentary : Retains an alarm output only until the alarm is canceled.

* The Alarm Output is equipped with a relay circuit. The operation of the alarm output port is as shown in the diagram below.

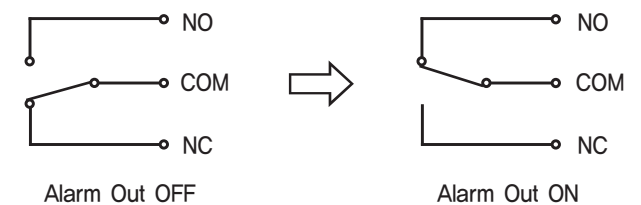

Notes

- Connecting the power connector and GND incorrectly to the NC/NO and COM ports may cause a short circuit and fire, damaging the camera.
- The maximum power capacity of the built-in relay is 30VDC/2A, 125VAC/0.5A, and 250VAC/0.25A. Operating the camera beyond the capacity may decrease the camera's lifespan and damage it.

Functional Description

25.3. Aux Output

► Main Menu/Alarm Setting/Aux Output

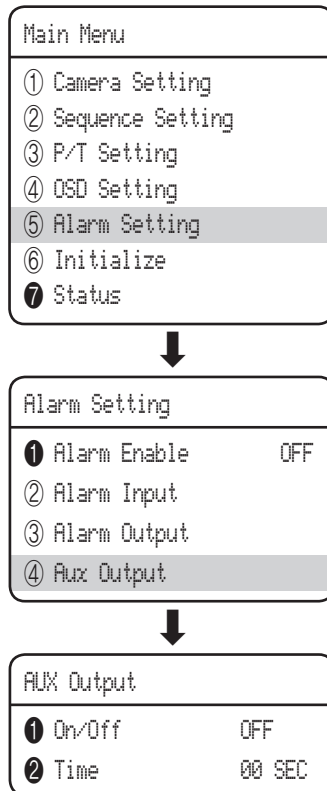

AUX Output menu is to operate the camera's peripheral devices such as lamps and sirens through the controller and switches as well as through network communications.

☞ On/Off :

- Cancels or activates the Aux function.

☞ Time :

Enables setting up a duration for the Aux output when the Aux command is transmitted from the controller. A duration can be selected from a minimum of 1 second to a maximum of 60 minutes.

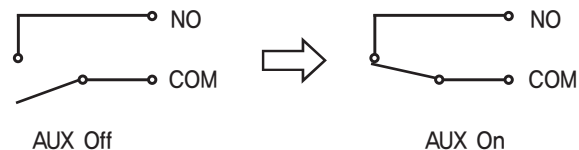

Notes

- Connecting the power connector and GND incorrectly to the Aux terminal's NO and COM ports may cause a short circuit and fire, damaging the camera.
- The maximum power capacity of the built-in relay is 30VDC/2A, 125VAC/0.5A, and 250VAC/0.25A. Operating the camera beyond the capacity may decrease the camera's lifespan and damage it.

Functional Description

Initialize

26. Initialization Menu

► Main Menu/Initialize

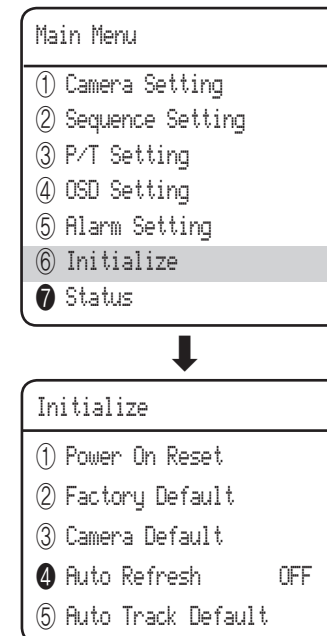

☞ Power On Reset :

Restarts the camera.

☞ Factory Default :

Enables resetting the camera to its factory default settings. When the mode is selected, all custom data such as preset locations is deleted from the camera.

Use this function if it is necessary to reset the settings of the camera.

☞ Camera Default :

This mode can be used if the camera module has been replaced and you want to keep the camera's existing settings for the new module.

To do reset the camera, first replace the old module with a new camera module. When the replacement is properly installed, turn on the module, then execute this command.

☞ Auto Refresh :

Enables optimizing the status of the camera's built-in electric circuits and components on a regular basis. (A regular operation can be scheduled.)

This mode can be used to maintain and repair the current settings of the camera when anomalous operations occur: e.g. The camera happened to directly face a light source, or the settings have been canceled after the camera repeatedly rotated in all four directions for a long time to monitor a specific location.

The default setting is Off.

- Off, 1~7 Days: Selecting Off disables Auto Refresh and but automatically executes it after 1~7 Days days has passed. action once the refresh is complete.

Functional Description

* Auto Refresh takes approximately 10 seconds to finish. If Auto Refresh activates in the middle of a sequence action, the camera pauses the sequence action and performs an Auto Refresh, then resumes the sequence action once the refresh is complete.

Auto Track Default :

Enables resetting the Auto Track settings.

Operating Your Camera

Status

27. Status

▶ Main Menu/Status

| Main Menu | |
|-----------|------------------|
| ① | Camera Setting |
| ② | Sequence Setting |
| ③ | P/T Setting |
| ④ | OSD Setting |
| ⑤ | Alarm Setting |
| ⑥ | Initialize |
| ⑦ | Status |



| Camera Status | |
|---------------|----------------|
| CAM MODEL | = 37PC |
| CAM VERSION | = 2.3 |
| DOME VERSION | = 0.10 |
| CON PROTOCOL | = SAMSUNG TW |
| DOME ID | = 001 |
| CONTROLLER | = Simplex-9600 |
| TRACK VERSION | = 0.10 |

Displays the settings and version of the dome camera.

Cam Model :

Indicates the model name of the camera.

Cam Version :

Indicates the software version of the camera.

Dome Version :

Indicates the version of the camera control board.

CON Protocol :

Indicates the status of the current protocol.

Dome ID :

Dome Camera ID

Controller :

Indicates the settings of the current communications mode.

Track Version :

Indicates the Auto Track software version of the camera.

Product Specification

| | SPD-3700T | SPD-3700 | SPD-3310 | SPD-2700 |
|---------------------------|---|--|--|----------|
| Imaging Device | 1/4 inch, Super HAD color CCD | | | |
| TV Standard | NTSC / PAL | | | |
| Total Pixels | NTSC:811(H) x 508(V) / PAL:795(H) x 596(V) | | | |
| Effective Pixels | NTSC:768(H) x 494(V) / PAL:752(H) x 582(V) | | | |
| Scanning System | 2:1 Interlace | | | |
| Synchronization | Internal | Internal/External(AC Line Lock) | | |
| Horizontal Scan Rate | NTSC:15.734 KHz / PAL:15.625 KHz | | | |
| Vertical Scan Rate | NTSC:59.94 Hz / PAL: 50 Hz | | | |
| Horizontal Resolution | 550 TV Line(Color)/680 TV Line(B/W) | | | |
| Min. Illumination | 0.4 Lux @ F1.6 (Color), 0.001Lux @ F1.6 (Sens-up 256X) 0.02 Lux @ F1.6 (B/W) | | | |
| S/N (Y Signal) | 50 dB | | | |
| Video Output | CVBS:1.0Vp-p/75Ω | | | |
| Zoom Ratio | 37X (Optical), 12X (Digital) | 33X (Optical), 12X (Digital) | 27X(Optical), 12X(Digital) | |
| Focal Length | 3.5~129.5mm (F1.6 ~3.9) | 3.5~115.5mm (F1.6 ~3.6) | 3.5~94.5mm (F1.6~2.9) | |
| Min. Object Distance | 1.9m | | | |
| Angular Field of view | H:55.5°(Wide)~1.59°(Tele) V:42.5°(Wide)~1.19°(Tele) | H:55.5°(Wide) ~1.77°(Tele) V:42.5°(Wide) ~1.33°(Tele) | H:55.5°(Wide) ~2.24°(Tele) V:42.5°(Wide) ~1.79°(Tele) | |
| Focus | AUTO / MANUAL / ONE-SHOT | | | |
| Zoom Speed | 2.5sec | | | |
| IRIS | AUTO/MANUAL | | | |
| Lens Initialization | Built-In | | | |
| Auto Tracking | Built-In | - | | |
| Horizontal Rotation Angle | 360° Endless | | | |
| Horizontal Rotation Speed | Manual:0.024°/sec ~ 120°/sec, Preset 500°/sec | | | |
| Vertical Rotation Angle | -5° ~ 185° | | | |
| Vertical Rotation Speed | Manual:0.024°/sec ~ 120°/sec, Preset 500°/sec | | | |
| Preset Position | 255 | | | |
| Preset Accuracy | ±0.1° | | | |
| Camera ID | 255 | | | |
| Day & Night | AUTO / COLOR / BW | | | |
| Backlight | USER / HLC / OFF | | | |
| Motion Detection | ON/OFF | | | |
| Stabilizer | ON/OFF | | | |
| Privacy Mask | ON/OFF (8 Areas) | | | |
| SSNR | LOW/MEDIUM/HIGH/OFF | | | |

Product Specification

| | | |
|------------------------------------|---|----------|
| Sens-up | On/Off (Selectable limit ~ 256X) | |
| Gain Control | LOW/MEDIUM/HIGH/MANUAL/OFF | |
| White Balance | ATW/INDOOR/OUTDOOR/AWC/MANUAL | |
| Electronic Shutter | AUTO(NTSC:1/60~120,000sec, PAL:1/50~120,000sec)/MANUAL/A.FLK | |
| Serial Com. | RS-422/485 | |
| Protocol | Samsung Techwin, Pelco-D, Pelco-P, Panasonic, Honeywell, AD, Vicon, Samsung Electronics | |
| Alarm | 4 In, 2 Out, 1 Aux | |
| Digital Flip | ON/OFF | |
| Operating Temperature/ Humidity | -10°C to +50°C / 20% to 80% RH | |
| Storage Temperature/ Humidity | -20°C to +60°C / 20% to 95% RH | |
| Input Voltage | AC24V ± 10% | |
| Power Consumption | Max. 15W | Max. 13W |
| External Dimensions (Ø×D) | Ø155×243.4mm | |
| Weight | 2Kg | |

DECLARATION OF CONFORMITY

| | |
|-------------------------------------|--|
| Application of Council Directive(s) | EMC-Directive 92/31 EEC and its amendments |
| Manufacturer's Name | SAMSUNG TECHWIN CO., LTD |
| Manufacturer's Address | SAMSUNG TECHWIN CO., LTD 42, SUNGJU-DONG CHANGWON-CITY, KYUNGNAM, KOREA, 641-716 |
| European Representative Name | |
| European Representative Address | |
| Equipment Type/Environment | Dome Camera |
| Model Name | SPD-3700T/3700/3310/2700 |
| Beginning Serial NO. | S8110001 |
| Year of Manufacture | 2008.11.29 |
| Conformance to | EN 55022 : 2006 EN 50130-4 : 2003 |

We, the undersigned, hereby declare that the equipment specified above conforms to the above Directive(s).

| | | |
|--------------|--------------------------|--------------------------------|
| Manufacturer | SAMSUNG TECHWIN CO., LTD | Legal Representative in Europe |
| Signature | <i>Han Seug Kim</i> | Signature |
| Full Name | HAN SEUG KIM | Full Name |
| Position | QUALITY CONTROL MANAGER | Position |
| Place | CHANGWON, KOREA | Place |
| Date | 2008.11.29 | Date |

MEMO

SAMSUNG TECHWIN



SALES NETWORK

· **SAMSUNG TECHWIN CO.,LTD.**

145-3, Sangdaewon1-dong, Jungwon-gu, Seongnam-si, Gyeonggi-do, 462-703, Korea
TEL : +82-31-740-8151~8 FAX : +82-31-740-8145

· **SAMSUNG TECHWIN AMERICA Inc.**

1480 Charles Willard St. Carson, CA 90746, UNITED STATES
TEL : +1-310-632-1234 FAX : +1-310-632-2195

· **SAMSUNG TECHWIN EUROPE CO., LTD.**

Samsung House, 1000Hillswood Drive, Hillswood Business
Park Chertsey,Surrey,UNITED KINGDOM KT16 OPS
TEL : +44-1932-45-5308 FAX : +44-1932-45-5325

www.samsungtechwin.com
www.samsungcctv.com

S.No:Z6806096601A
VAN 09. 01