

SAMSUNG TECHWIN

SYSTEM CONTROLLER

User Manual

SPC-6000

A large, stylized graphic of the Samsung logo. The word "SAMSUNG" is rendered in a bold, black, sans-serif font with a slight 3D effect. It is centered within a complex, abstract background of white, glowing, and overlapping curved lines and swirls on a dark background, creating a sense of motion and energy.

SAMSUNG

The official Samsung logo, consisting of the word "SAMSUNG" in a white, bold, sans-serif font, enclosed within a black, horizontally-oriented oval shape.

SAMSUNG

System Controller

User Manual

Copyright

©2010 Samsung Techwin Co., Ltd. All rights reserved.

Trademark

 SAMSUNG TECHWIN is the registered logo of Samsung Techwin Co., Ltd.

The name of this product is the registered trademark of Samsung Techwin Co., Ltd.

Other trademarks mentioned in this manual are the registered trademark of their respective company.

Restriction

Samsung Techwin Co., Ltd shall reserve the copyright of this document. Under no circumstances, this document shall be reproduced, distributed or changed, partially or wholly, without formal authorization of Samsung Techwin.

Disclaimer

Samsung Techwin makes the best to verify the integrity and correctness of the contents in this document, but no formal guarantee shall be provided. Use of this document and the subsequent results shall be entirely on the user's own responsibility.

Samsung Techwin reserves the right to change the contents of this document without prior notice.

Warranty

If the product does not operate properly in normal conditions, please let us know. Samsung Techwin will resolve the problem for free of charge. The warranty period is 3 years. However, the followings are excluded:

- If the system behaves abnormally because you run a program irrelevant to the system operation.
- Deteriorated performance or natural worn-out in process of time

IMPORTANT SAFETY INSTRUCTIONS

1. Read these instructions.
2. Keep these instructions.
3. Heed all warnings.
4. Follow all instructions.
5. Do not use this apparatus near water.
6. Clean only with dry cloth.
7. Do not block any ventilation openings, Install in accordance with the manufacturer's instructions.
8. Do not install near any heat sources such as radiators, heat registers, stoves, or other apparatus (including amplifiers) that produce heat.
9. Do not defeat the safety purpose of the polarized or grounding-type plug. A polarized plug has two blades with one wider than the other. A grounding type plug has two blades and a third grounding prong. The wide blade or the third prong are provided for your safety, If the provided plug does not fit into your outlet, consult an electrician for replacement of the obsolete outlet.
10. Protect the power cord from being walked on or pinched particularly at plugs, convenience receptacles, and the point where they exit from the apparatus.
11. Only use attachments/ accessories specified by the manufacturer.
12. Use only with the cart, stand, tripod, bracket, or table specified by the manufacturer, or sold with the apparatus. When a cart is used, use caution when moving the cart/apparatus combination to avoid injury from tip-over.
13. Unplug this apparatus during lightning storms or when unused for long periods of time.
14. Refer all servicing to qualified service personnel. Servicing is required when the apparatus has been damaged in any way, such as power-supply cord or plug is damaged, liquid has been spilled or objects have fallen into the apparatus, the apparatus has been exposed to rain or moisture, does not operate normally, or has been dropped.



overview

WARNING

TO REDUCE THE RISK OF FIRE OR ELECTRIC SHOCK, DO NOT EXPOSE THIS PRODUCT TO RAIN OR MOISTURE. DO NOT INSERT ANY METALLIC OBJECT THROUGH THE VENTILATION GRILLS OR OTHER OPENINGS ON THE EQUIPMENT.

Apparatus shall not be exposed to dripping or splashing and that no objects filled with liquids, such as vases, shall be placed on the apparatus.

CAUTION

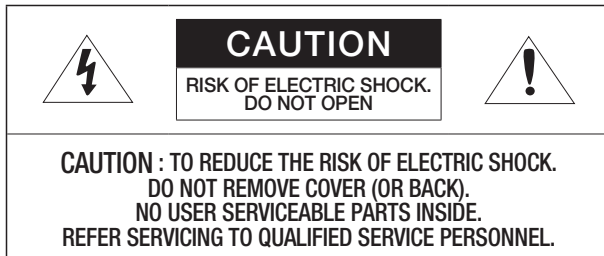

EXPLANATION OF GRAPHICAL SYMBOLS











The lightning flash with arrowhead symbol, within an equilateral triangle, is intended to alert the user to the presence of “dangerous voltage” within the product’s enclosure that may be of sufficient magnitude to constitute a risk of electric shock to persons.

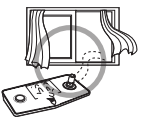

The exclamation point within an equilateral triangle is intended to alert the user to the presence of important operating and maintenance (servicing) instructions in the literature accompanying the product.

Please read the following recommend safety precautions carefully.

<p>Do not Place this apparatus on an uneven surface.</p> 	<p>Do not install on a surface where it is exposed to direct sunlight, near heating equipment or heavy cold area.</p> 
<p>Do not place this apparatus near.</p> 	<p>Do not attempt to service this apparatus yourself.</p> 
<p>Do not place a glass of water on the product.</p> 	<p>Do not install near any magnetic sources.</p> 
<p>Do not block any ventilation openings.</p> 	<p>Do not place heavy items on the product.</p> 

User's Manual is a guidance book on how to use the product.

Below is a key to the following signs that are used in this manual.

- Reference : Providing useful information for the user.
- Notice : If the instructions are not followed correctly damage to the goods or person may occur.
- ※ For safety please read this manual for the before using of goods and keep it in the safe place.

overview



This equipment has been tested and found to comply with the limits for a Class A digital device, pursuant to part 15 of the FCC Rules. These limits are designed to provide reasonable protection against harmful interference when the equipment is operated in a commercial environment.

This equipment generates, uses, and can radiate radio frequency energy and, if not installed and used in accordance with the instruction manual, may cause harmful interference to radio communications. Operation of this equipment in a residential area is likely to cause harmful interference in which case the user will be required to correct the interference at his own expense.



Samsung Techwin cares for the environment at all product manufacturing stages, and is taking measures to provide customers with more environmentally friendly products.

The Eco mark represents Samsung Techwin's devotion to creating environmentally friendly products, and indicates that the product satisfies the EU RoHS Directive.



Correct Disposal of This Product (Waste Electrical & Electronic Equipment)

(Applicable in the European Union and other European countries with separate collection systems)

This marking on the product, accessories or literature indicates that the product and its electronic accessories (e.g. charger, headset, USB cable) should not be disposed of with other household waste at the end of their working life. To prevent possible harm to the environment or human health from uncontrolled waste disposal, please separate these items from other types of waste and recycle them responsibly to promote the sustainable reuse of material resources.

Household users should contact either the retailer where they purchased this product, or their local government office, for details of where and how they can take these items for environmentally safe recycling.

Business users should contact their supplier and check the terms and conditions of the purchase contract. This product and its electronic accessories should not be mixed with other commercial wastes for disposal.

CONTENTS

OVERVIEW

3

- 3 Important Safety Instructions
- 9 Key Features
- 10 What's Included
- 11 System Controller at a Glance

INSTALLATION

14

- 14 Precautions
- 15 Before Installation
- 15 Adjusting the Screen Angle of the System Controller
- 16 Switching the Layout of Joystick and Jog Shuttle

CONNECTING TO AN EXTERNAL DEVICE

17

- 17 To Connect a RS-485 Device
- 23 Connecting to other System Controller

USING THE MENU

24

- 24 Getting Started
- 24 Controlling the PTZ Camera
- 30 Controlling DVR
- 32 Controlling MATRIX

overview

MENU SETTING

34

- 34 To Access the Main Menu
- 34 PTZ setting
- 35 DVR Setting
- 35 Controller Setting
- 40 Firmware Update
- 42 To Check the Controller Information

APPENDIX

43

- 43 Specifications
- 44 Q & A
- 45 GPL/LGPL Software License

KEY FEATURES

SPC-6000 system controller enables you to control external devices such as PTZ camera, DVR, MATRIX using RS-485 communications.

It provides a user-friendly interface with onscreen menu, touch screen and joystick.

- Long-distance remote control
- With RS-485 communications, the control distance is a maximum of 1km.
- Integrated system control
- With a single system controller, you can control all cameras (receiver unit), DVRs and MATRIX.
- Multiple system controllers can be connection.
- You can control different sites and connect up to 16 controllers simultaneously.
- Switch the joystick and jog shuttle module positions.
- For the user's convenience, the positions of the joystick and jog shuttle module can be switched between left and right.
- User-friendly interface

The operation status of the system control is displayed on the screen; the touch-screen enables you to select a menu with ease; the joystick makes your control simple and easy.

❖ Compatibility List

- Camera
- DVR
SRD-XXXX series, SHR-8/7/6XXX series, SHR-604X series, SVR-1670
- PC Based DVR
SPR-7XXX series, SPR-9XXX series

❖ Adapter Specifications

- Voltage : 1) Input (AC) : 100~240V
2) Output (DC) : 12V
- Capacity (output current) : 4A
- Standard load at low speeds : 48W
- Temperature : 1) Operating Temperature : 0 ~+40℃
2) Storage : -20 ~+60℃

overview

WHAT'S INCLUDED

Unpack the product package and place the product on the floor or a flat surface.
Check if the following components are all included in the product package.



Main Unit

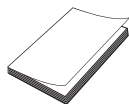

User Manual

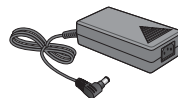

Power Adaptor 1EA



Power Cable 1EA

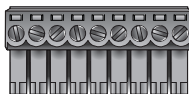

Terminal Block 1EA

SYSTEM CONTROLLER AT A GLANCE

Front Side

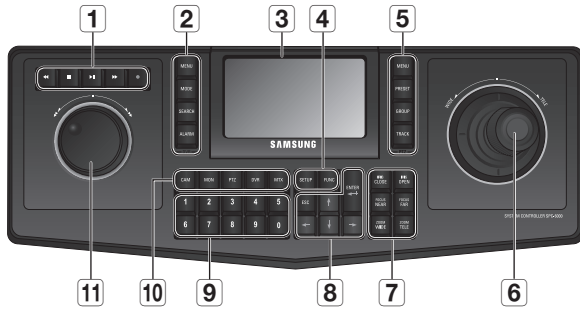



Item	Description
1 DVR Play Bar	Play/Pause, Fast Forward/Fast Backward, Stop, Record
2 DVR Control Bar	Access the selected menu, search, select a split mode, or control the alarm.
3 LCD Display	Display the operation status and the setup menu of the system controller.
4 SETUP Bar	In a combination with the [FUNC] button, you can access the Setup menu.
5 Camera Operation Bar	Access the selected PTZ menu, or execute Preset, Group or Track.
6 Joystick Controller	You can manipulate the Pan/Tilt operation up or down in connection with the PTZ camera or receiver unit. Turn the joystick clockwise or counter clockwise to control zooming. You can control the direction of the connected controller from the menu screen of the controller.

overview

Item	Description	
7 Camera Lens Bar	IRIS	Control Iris (CLOSE/OPEN)
	FOCUS	Adjust the focus (NEAR/FAR)
	ZOOM	Zoom In/Out (WIDE/TELE)
8 Navigate, ENTER, ESC	Navigate	Navigate through menu items.
	ENTER	Move to a desired item using the navigation buttons and select it.
	ESC	Cancel the current operation.
9 Number (0-9) Buttons	Used to specify numeric characters for camera, monitor, DVR or Preset settings.	
10 Controller Selection Bar	Used to select a camera, monitor or DVR.	
11 Jog Shuttle	Jog	Used to search for forward /reverse frame in DVR play mode.
	Shuttle	Forward/Reverse /Play/FF/REW in DVR play mode.

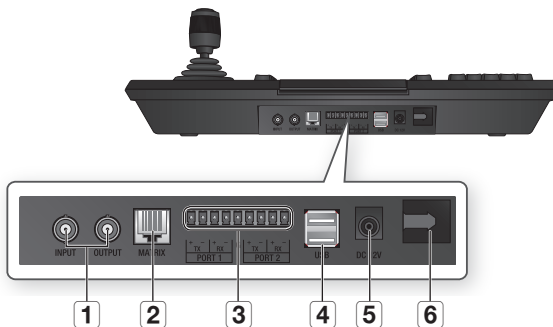
Rear Side



Item	Description	
1 Video In/Out	Video input/output port	
2 MATRIX	Matrix connection port	
3 RS-485	PORT 1	Connected to a controller such as camera or DVR through RS-485 communications.
	PORT 2	Connect to other SPC-6000 system controller.
4 USB Port	Used for backup of the system controller settings or upgrading the firmware.	
5 Power	DC 12V input port (— —⊖ — ⊕)	
6 Cable Hook	To prevent the power cable from being loose.  ■ Be sure to use the cable hook when installing and using the controller.	

-  ■ The MATRIX port contains the power line so you don't need to supply DC 12V separately if using the MATRIX port.
- The MATRIX port contains a single line controlling the main and subsidiary control signals.
- The MATRIX signal is of TTL level.

installation

PRECAUTIONS

Before you install the product, read through and comply with the following instructions.

- The product is designed for indoor use only.
 - Keep it away from water or moisture.
 - Do not put excessive force on it.
 - Do not pull out the power cable forcibly.
 - Do not dismantle it at your own.
 - Use only the rated I/O range.
 - Use only the provided power cable.
 - Use the power plug containing the earth wire if available.
 - Install the system controller on a flat table.
 - The layout of the main unit and the wiring system are critical for a proper system operation.
 - If the devices are too close with each other or in a poor-ventilating environment, the system may not work properly.
Inaccessibility to the system makes the repair difficult or even impossible.
 - To prevent a system failure or to reduce the system shutdown, make enough room for ventilation and close the cover firmly.
 - Do not dismantle the system controller at will as a high voltage runs inside the system controller.
- Operation Temperature : 0°C ~ 40°C
 - Storage Temperature : -20°C ~ 60°C
 - Operation Humidity : 10%~70% RH
 - Storage Humidity : 10% ~ 90% RH
 - Power Consumption : DC 12V, Max 4W (— — (— — +)

BEFORE INSTALLATION

- You must turn off the product before installing it.
- A severe impact or vibration may cause a system failure.
- Keep it away from a strong magnetic field or electric interference, or wireless devices such as radio or TV set.
- Keep the installation site clean and dust-free all the time while or after you have installed the product.
- Place it on an unsealed, flat surface at an optimal temperature.
Install it at least 15cm away from the wall.
- Do not close the ventilation hole or put a conductive object in it.
- Do not expose it to the direct sunlight. Keep the accessories or tools out of people's reach in an attempt to prevent a risk of physical damage.
- Leaving an abnormal smoke or smell as it is may lead to a fire or electric shock.
If this is the case, turn off the product immediately and contact us for a technical assistance.
- Take an appropriate action if you find: damp floor, unearthed power extension cord, peeled-off power cable, or absence of safety grounding.



- Use a dry cloth to wipe it out. If badly dirty or stained, use a cloth soaked into neutral detergent to wipe it out.
Do not use volatile solvents such as alcohol, benzene or thinner that may damage the product surface.
- Do not operate the LCD monitor at a high temperature; recommended to use the screen saver for power conservation.

ADJUSTING THE SCREEN ANGLE OF THE SYSTEM CONTROLLER

You can pull the screen forward for a better view.



installation

SWITCHING THE LAYOUT OF JOYSTICK AND JOG SHUTTLE

For convenience you can switch the position of joystick and jog shuttle module.

- ! To switch between left and right, turn off the system controller and switch the modules manually. Or, press <Change> in the controller setup menu and switch the modules manually. (▶ page 38)

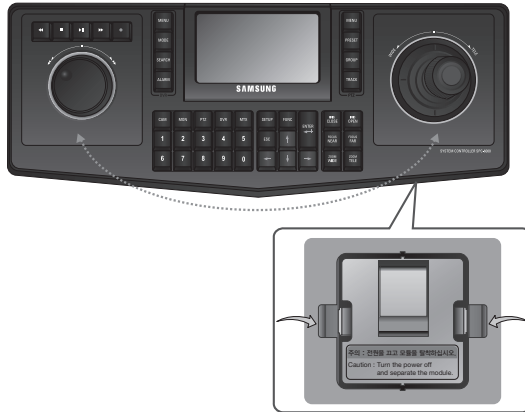

<Bottom>

1. Press down both hooks on the bottom of the system controller to remove the module.
2. Remove both joystick and jog shuttle modules from the controller and switch the position. When done, insert them until you hear a click.



connecting to an external device

SPC-6000 system controller can be used in connection with an external device such as camera or DVR.

TO CONNECT A RS-485 DEVICE

With the system controller, you can control the PTZ camera or DVR that supports RS-485 communication protocols.

1. Connect the rear PORT 1 with RS-485 port of the PTZ camera or DVR.
2. According to the external device connected, select Half Duplex or Full Duplex connection.
 - ✍️ ■ For the Half Duplex system, use TX +/- terminals.
 - For RS-485 communications, pay special attention to the polarity (+/-).
 - Use the provided terminal block in the product package.
 - Check if the RS-485 device is compatible with SPC-6000.

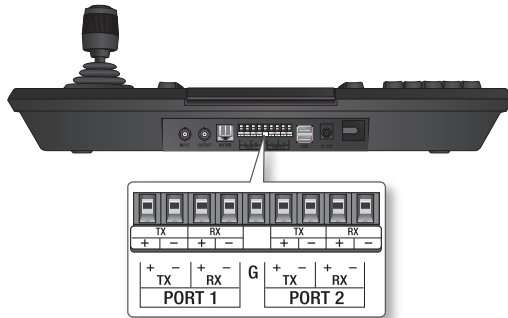

connecting to an external device

If connecting the keyboard without using MATRIX

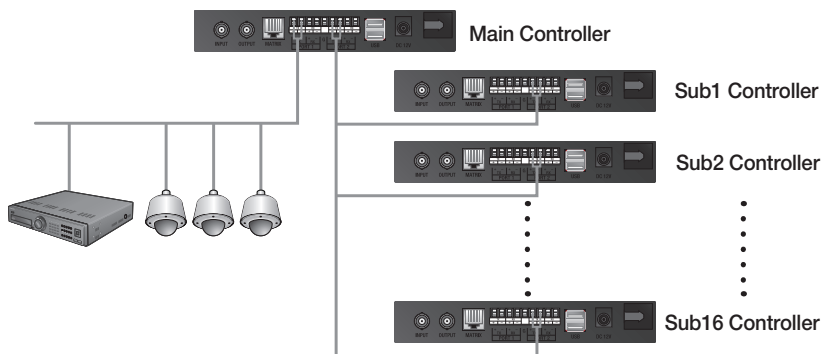

If connecting the keyboard using MATRIX

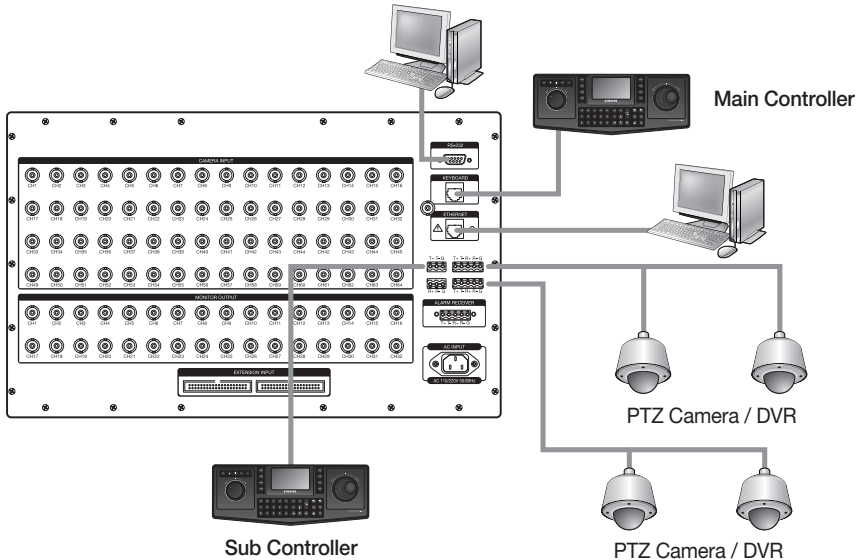

1. Connect the **[MATRIX]** port of the main controller to the **[KEYBOARD]** port of the matrix. The MATRIX port contains the power line so you don't need to supply DC 12V separately.
2. Connect TX+ and TX- of the sub controller to T+ and T- of the matrix, respectively.
 - The baud rate between sub controllers in sync with MATRIX will be fixed to 9600 bps.
 - The MATRIX ID is fixed to <SUB 09>.
3. Connect DVR and PTZ camera to MATRIX.

connecting to an external device

Connecting the PTZ Camera

By connecting RS-485 port on the rear of the PTZ camera with PORT 1 of SPC-6000, you can control the camera.

- Depending on the camera, the polarity may differ.
For more information, refer to the user manual of the PTZ camera.

For the half duplex system

- Connect RX (+) of RS-485 port of the PTZ camera with TX (+) of PORT 1 of SPC-6000.
- Connect RX (-) of RS-485 port of the PTZ camera with TX (-) of PORT 1 of SPC-6000

For the full duplex system

- Connect RX (+) of RS-485 port of the PTZ camera with TX (+) of PORT 1 of SPC-6000.
- Connect RX (-) of RS-485 port of the PTZ camera with TX (-) of PORT 1 of SPC-6000.
- Connect TX (+) of RS-485 port of the PTZ camera with RX (+) of PORT 1 of SPC-6000.
- Connect TX (-) of RS-485 port of the PTZ camera with RX (-) of PORT 1 of SPC-6000.

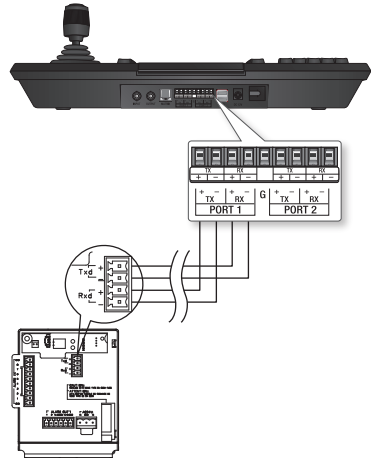

Connecting SRD-16XX/8XX series, SHR-8/7/6XXX series or SVR-1670 with DVR

Connect between DVR and SPC-6000 using RS-485 port on the rear of the DVR.

For the half duplex system

- Connect TX (+) of RS-485 port of the DVR with TX (+) of PORT 1 of SPC-6000.
- Connect TX (-) of RS-485 port of the DVR with TX (-) of PORT 1 of SPC-6000.

For the full duplex system

- Connect TX (+) of RS-485 port of the DVR with RX (+) of PORT 1 of SPC-6000.
- Connect TX (-) of RS-485 port of the DVR with RX (-) of PORT 1 of SPC-6000.
- Connect RX (+) of RS-485 port of the DVR with TX (+) of PORT 1 of SPC-6000.
- Connect RX (-) of RS-485 port of the DVR with TX (-) of PORT 1 of SPC-6000.

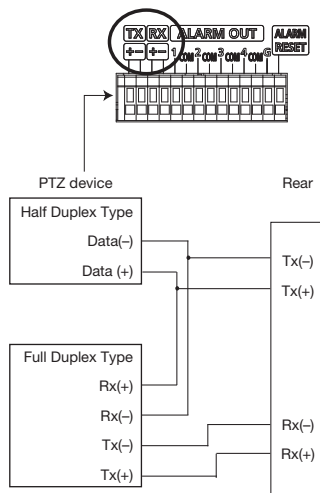

connecting to an external device

Connecting SRD-4XX or SHR-604X series with DVR

Connect RS-485 port on the rear of SRD-4XX or SHR-604X series with SPC-6000.

❖ For the half duplex system

- Connect TX (+) of SRD-4XX or SHR-604X with TX (+) of PORT 1 of SPC-6000.
- Connect TX (-) of SRD-4XX or SHR-604X with TX (-) of PORT 1 of SPC-6000.

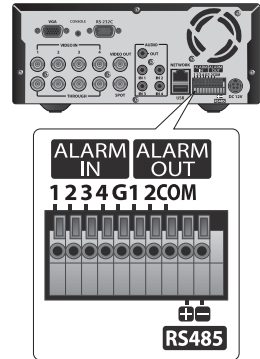

PC-based DVR

- Connect between PC-based DVR and SPC-6000 using RS-485 port on the rear of the DVR.
- Connect SIGNAL (+) of RS-485 port of the PC-based DVR with TX (+) of PORT 1 of SPC-6000.
- Connect SIGNAL (-) of RS-485 port of the PC-based DVR with TX (-) of PORT 1 of SPC-6000.

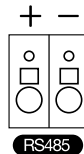

<SPR-9XXX Series>

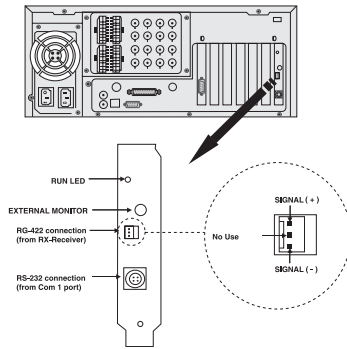

<SPR-7XXX Series>

CONNECTING TO OTHER SYSTEM CONTROLLER

- You can connect up to 16 controllers simultaneously.
- For communication settings of the controller, refer to “Sub List” of “Menu Setting”. (▶ page 37)

For the half duplex system

- Connect TX (+) of PORT 2 of SPC-6000 with TX (+) of PORT 2 of the other SPC-6000.
- Connect TX (-) of PORT 2 of SPC-6000 with TX (-) of PORT 2 of the other SPC-6000.

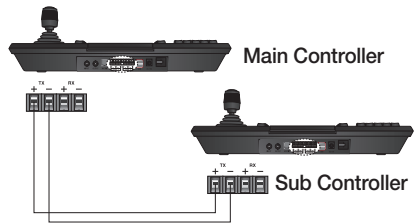

For the full duplex system

- Connect TX (+) of PORT 2 of the main controller SPC-6000 with RX (+) of PORT 2 of the sub controller SPC-6000.
- Connect TX (-) of PORT 2 of the main controller SPC-6000 with RX (-) of PORT 2 of the sub controller SPC-6000.
- Connect RX (+) of PORT 2 of the main controller SPC-6000 with TX (+) of PORT 2 of the sub controller SPC-6000.
- Connect RX (-) of PORT 2 of the main controller SPC-6000 with TX (-) of PORT 2 of the sub controller SPC-6000.

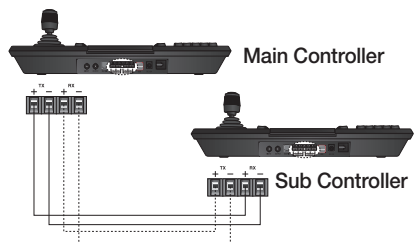

- You must use PORT 2 if you want to connect to other system controller.

using the menu

GETTING STARTED

1. Turn on all system component devices.



2. When you connect the power adapter to the rear port of the system controller, the login dialog appears.
3. Use the number pad to enter the password and press [ENTER].
The main menu of the PTZ control system appears.
 - The default password is "4321".



CONTROLLING THE PTZ CAMERA

To enter PTZ control mode

Press [PTZ] of the controller.

To select a camera

1. Use the number buttons to enter the number of the camera of your choice.
2. Press [CAM] or [ENTER].



PAN/TILT Control

You can use the controller joystick to adjust the pan/tilt angle of the camera.
The farther from the center of the joystick is, the faster the moving speed becomes.

ZOOM

Turn the joystick clockwise, or press **[ZOOM TELE]** to control the zoom-in operation of the camera.
Turn the joystick counter clockwise, or press **[ZOOM TELE]** to control the zoom-out operation of the camera.

FOCUS

Press **[FOCUS FAR]** or **[FOCUS NEAR]** on the controller to fit the camera focus.

IRIS

Press **[IRIS OPEN]** or **[IRIS CLOSE]** on the controller to adjust the brightness of the camera video.

PRESET

Move the camera to a pre-determined point.

To set a preset

1. Select a camera that you want to set a preset for.
2. Use the joystick to move the camera to a desired point.
3. Press **[SETUP]** and enter a desired number using the number buttons.
Then, press **[PRESET]**.

To execute the preset

1. Select a camera.
2. Enter a desired number(s) using the number buttons and press **[PRESET]**.
3. The preset will be executed.



- For SCP-3430, SCP-2430, SCP-3250 and SCP-2250 PTZ dome series, a maximum of 512 presets are supported only if Samsung E protocol is selected.

using the menu

SWING

You can move the camera between two preset points to monitor the course.

Swing setup

1. Select <SWING> from the menu screen.
2. Press <SETTING>.

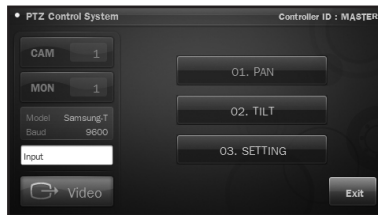

3. Use the number buttons to select PAN/TILT and specify the start preset and end preset.
4. Specify the speed and dwell time.
5. Press <Save>.

To execute the swing

1. Select <SWING> from the menu screen.
2. Use the number buttons to select PAN or TILT for the swing type.
3. The swing function will be executed.



GROUP

You can make a group of multiple presets before calling them in sequence.

To set a group

1. Select <GROUP/SCAN> from the menu screen.
2. Select <Group Setting>.
3. Enter a group number and press [ENTER].
4. Specify the speed and dwell time.
5. Press <Save>.



To execute the group function

1. Select <GROUP/SCAN> from the menu screen.
2. Select <Group Executing>.
3. Enter a group number and press [ENTER].
4. The group function will be executed.

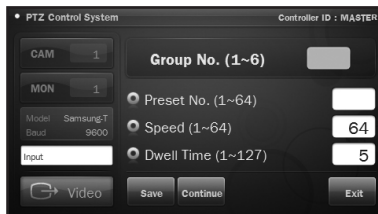

using the menu

TOUR

You can make a tour of at least one group before executing the groups in sequence.

To set a tour

1. Select <TOUR> from the menu screen.
2. Select <Tour Setting>.
3. Each time you press the number of a group that you want to add to the tour, the group will be added to the tour.
 - You can add up to 6 groups to a tour.
4. Press <Save> to apply your settings.



To execute the tour function

1. Select <TOUR> from the menu screen.
2. Select <Tour Executing>.
3. The tour function will be executed.

TRACE

With the joystick or camera buttons, you can instruct the controller to record the camera movement for a specific time and repeat the movement.

To set a trace

1. Select <TRACE/PATTERN> from the menu screen.
2. Select <RECORD>.
3. Specify a trace number to record.
4. With the joystick or camera buttons, control the camera movement as you wish.

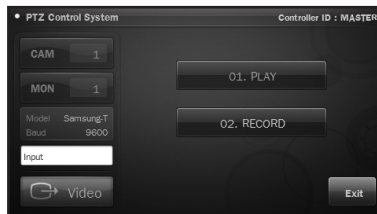

To execute a trace

1. Select <TRACE/PATTERN> from the menu screen.
2. Select <PLAY>.
3. Specify a trace number to execute.
4. The trace function will be executed.

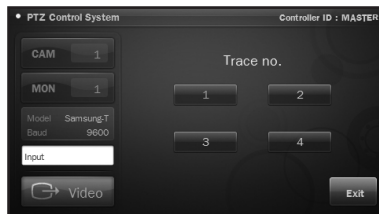

Auto Focus

1. Select <A/F> from the menu screen.
2. The auto focus feature will be activated.

RESET

1. Select <RESET> from the menu screen.
2. The camera will be reset.



TARGET LOCK

1. Select <TARGET LOCK> from the menu screen.
There appears a rectangle box on the camera video.
2. Move to an object to track down and press [ENTER].
 - This is applied only to a camera that supports the tracking function.

TRACK

1. Select <TRACK> from the menu screen.
2. The track function will be executed.
 - This is applied only to a camera that supports the tracking function.

using the menu

CONTROLLING DVR

Depending on the model, the DVR may have different features available. For details, refer to the applicable user manual.

- An improper setting may cause a problem using the DVR.

To select a DVR

1. Press [DVR].
2. Use the number buttons to enter a DVR number (0~255) and press [ENTER].



3. The main menu screen appears. It differs depending on the model.

- For a DVR that supports SRD protocols, the menu screen displays only menu items available.
- If you connect a DVR that supports SRD protocols, the PTZ settings will be made automatically.



To select a DVR channel

1. Use the number buttons to enter the number for a desired DVD channel.
2. Press [CAM].

To control the DVR menu

1. To control the menus of the selected DVR, press [MENU] in the DVR control bar.
2. Use the direction buttons to move to a desired menu item and press [ENTER].

To control the PTZ device that is connected to DVR

Depending on the DVR model, you may not control the PTZ device that is connected to the DVR. If this is the case, press [PTZ] to switch from DVR control mode to camera control mode.

To control the PTZ device in DVR mode

1. Press [PTZ] in the bottom right corner of the DVR menu screen.
2. Use the joystick to control the PTZ camera in connection with the DVR.
For details, refer to the user manual of the DVR.

DVR login

You must access the DVR menu with the right user account.

- Select <Input> to deactivate the input box. Now you can use only the number buttons to switch the channel or enter the password for the DVR without using the [CAM] button. Select <Input> again to return to the previous mode.



using the menu

CONTROLLING MATRIX

To control monitor and camera in Matrix mode

You can control the monitor and camera in Matrix mode.

1. Press [MTX].
2. Select a monitor number and press [MON].
3. Select a camera number and press [CAM].
The selected monitor will play the video of the selected camera.



To play the current video on the previous monitor

Enter a number for the camera to select.

1. Press the camera number in the Matrix setup screen and press [CAM].
2. The previous monitor will play the video of the currently selected camera.

Auto Select

You can make a schedule of operations in the Matrix setup menu.

1. Select a monitor number in the Matrix setup menu and press [MON].
2. From the menu screen, press <Auto Select Set>.



3. When the <Auto Select Set> screen appears, select a monitor and a camera to connect and specify the dwell time.
4. When camera #1 settings are completed, press <Continue> and specify the dwell time for camera #2.
5. When completing the dwell time setting, press <Save>.

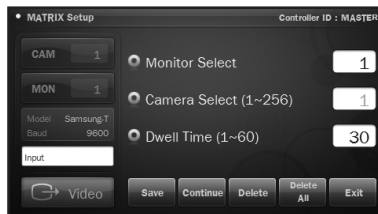

RUN / HOLD

RUN/HOLD will run or hold the Auto Select setting that you have made.

Press the combination of <All> + <RUN> to run Auto Select as you set.

Press the combination of <All> + <HOLD> to stop operating Auto Select and wait for your input.

- 
■ To instruct an operation for an individual monitor, press a combination of "monitor number" + <RUN> or "monitor number" + <HOLD>.

Alarm Play

If the sensor is triggered in Alarm Play mode, the siren will sound if the alarm unit has set the siren to ON, or you can control external devices using the indicators if the alarm unit has set the indicator control output.

To release the alarm of the alarm unit, press <Alarm Play> again.

menu setting

TO ACCESS THE MAIN MENU

1. Press a combination of [FUNC] + [SETUP] on the controller.
2. When the setup system screen appears, select a desired menu item.



PTZ SETTING

From the PTZ setup screen, you can specify the protocol and baud rate.

1. Press <PTZ> from the setup main screen.
2. Use the direction buttons or joystick to move to a desired menu.
3. You can change the settings using [ZOOM WIDE] or [ZOOM TELE].
4. When you have completed the settings of protocol and baud rate, press <Save>.
5. To exit the PTZ Setup screen, press <OK> or [ESC].



- Before moving to a different page, save your settings.

DVR SETTING

From the DVR setup screen, you can specify the DVR type and baud rate.

1. From the setup main screen, press <DVR>.
2. Use the direction buttons or joystick to select a camera number and specify the DVR type.
3. Specify the baud rate.
4. When done, press <Save>.
5. To exit the DVR Setup screen, press <OK> or [ESC].



- Before moving to a different page, save your settings.

CONTROLLER SETTING

Controller ID

You can select RS-485 or RS-422 for the communication system.

1. Select RS-485 or RS-422 for the communication system between controller and external devices.
2. Press the port button to specify the port ID.

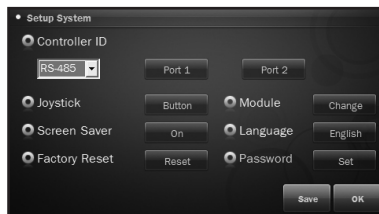

menu setting

PORT 1 ID

You can specify the controller ID if communicating with other devices.

1. Press **[Port 1]** from the control ID setup screen.
2. Specify the ID and press **<Save>**.

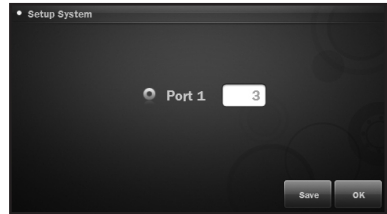

PORT 2 ID

You can specify the main or sub controller for communications between controllers, and also set the use of matrix and sub list.

1. Press **[Port 2]** from the control ID setup screen.
2. Use the direction buttons to select a desired item and select a communication system between controllers.
 - You must set the sub list in a multi-controller environment.
3. When done, press **<Save>**.

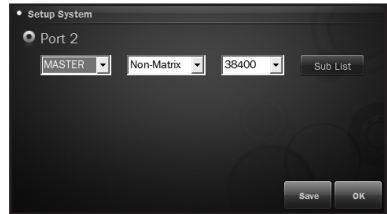

Sub List

For a communication system featuring the main and sub controllers, you must set the <Sub List>.

1. Press <Sub List>.
2. Use the direction buttons to select a desired item and configure the settings using [ZOOM WIDE] or [ZOOM TELE].
 - The MATRIX ID is fixed to <SUB 09>.
3. When done, press <Save>.
4. To exit the <Sub List> screen, press [OK] or [ESC].

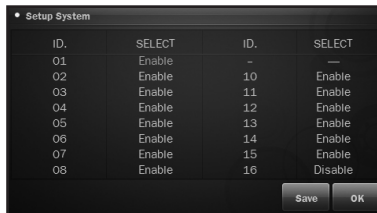

Joystick Button Operation

You can set the operation for the joystick button.

1. Press the joystick <Button>.
2. From the joystick button operation screen, select a function button for the selected joystick button.
3. Check the current setting, press <Exit>.

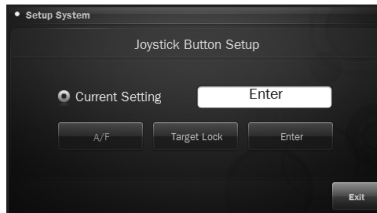

Screen Saver

You can set to activate the screen saver if you do not intend to use the controller for an extended time.

1. If you want to display a logo screen, set the screen saver to <On>.
2. To apply the changes, press <OK>; To cancel your setting, press <Exit>.

menu setting

Factory Default

You can return the current settings to the factory default.

1. Press **<Reset>**.
2. Press **<OK>**.
The current settings will return to the factory default.
3. To exit the menu, press **<Exit>**.



To switch between modules

You can switch the position between jog shuttle and joystick from left to right or vice versa.

1. Press **<Change>**.
2. From the Change Module screen that appears, you can switch the position between jog shuttle and joystick.
3. To exit the screen, press **<Exit>**.

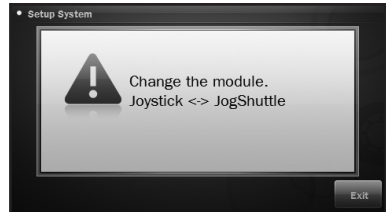

Language

You can select a preferred language for the user interface.

1. Press **<Language>**.
2. From the Language selection screen that appears, use the direction buttons or joystick to select a preferred language.
 - The language will be changed to the selected one immediately.
3. To exit the language selection screen, press **<Exit>**.



Password

You can enable or disable the controller's password.

1. Press the password <Set> button.
2. To enable the password, set it to <On>. If not, set it to <Off>.
3. Provide the current password.
4. To apply the changes, press <OK>; To cancel your setting, press <Exit>.



To change the password

You can change the password.

1. Press the password <Set> button.
2. Provide the current password.
3. Provide a new password.
4. To apply the changes, press <OK>; To cancel your setting, press <Exit>.



- The default password is "4321".

menu setting

FIRMWARE UPDATE

You can update the current firmware using the firmware files in the USB memory.

To update the controller firmware

You can download the latest firmware files and update the controller.

1. Connect the USB memory containing the latest firmware files to the system controller.
 2. From the menu setup screen, press **<Update>**.
 3. Press **<Update Controller Firmware>**.
 4. From the update screen, press **<OK>**.
The update status will be displayed in the progress bar.
 5. Wait until the system restarts after the update.
-  ■ Do not disconnect the USB memory or power cable during the update. Otherwise, it may fail to update the firmware or cause a system failure.



To backup the controller settings

If you want to change the controller or replace the camera, you can save the settings of the controller as a file and load the controller settings into a new camera.

1. From the menu setup screen, press **<Update>**.
2. Press **<Backup Controller Setting>**.
3. Press **<OK>**.
The backup process begins.



- Do not disconnect the USB memory or power cable during the backup. Otherwise, it may fail to backup the controller settings.



To restore the controller settings

If you have set the controller improperly or reset it, you can upload the current settings to a different controller.

1. From the menu setup screen, press **<Update>**.
2. Press **<Restore Controller Setting>**.
3. Press **<OK>**.
The restoration process begins.



- Do not disconnect the USB memory or power cable during the restoration. Otherwise, it may fail to restore the controller settings.



menu setting

TO CHECK THE CONTROLLER INFORMATION

You can check the model name and software version of the system controller.

Status Screen

You can check the controller status.

1. From the menu setup screen, press <Status>.
2. Check the controller status.



appendix

SPECIFICATIONS

Item	Description
Communication System	RS-485 / 422 (remote control range: max. 1km) TTL (for controlling the matrix)
Units to control	Max. 255
Baud Rate	2,400 ~ 38,400 bps
Compatibility	PTZ / DVR / MATRIX / RECEIVER
Protocol (PTZ)	Samsung-T, Samsung-E, PELCO-D, PELCO-P, Panasonic, Vicon, AD, Honeywell, ELMO, BOSCH, GE
Protocol (DVR)	SVR, SRD, SRP
Protocol (MATRIX)	SMX-25632
Protocol (RECEIVER)	Samsung-T
Multilingual Support	English, Spanish, French, Italian, German, Turkish, Polish, Russian, Portuguese, Swedish, Dutch, Czech, Serbian, Korean, Chinese, Japanese
LCD Display	5" TFT LCD + Touch LCD
USB Port	Backup / Restore, S/W Update
Video Port	BNC Video Input, Loop-Through Output
Joystick	PTZ control (3 axial twist zoom)
Jog Shuttle	Control DVD playback
Power	DC 12V, Max 4W
Operation Temperature	0°C ~ 40°C
Operation Humidity	10 ~ 70% (Non-condensing)
Dimensions	459.1(W) x 59.1(H) x 177.9(D) mm
Weight	Approx. 1.5 kg (adapter excluded)

appendix

Q & A

Problem	Action
I cannot communicate with the system controller.	<ul style="list-style-type: none">• Check if the RS-485 communication cable is connected properly.• Check if the address of the system controller is specified properly.• For specifying the address, refer to “Controller Setting” from “Menu Setting”. (▶ page 35)
The USB memory is not recognized properly.	<ul style="list-style-type: none">• Check if the USB memory works properly.• Use only one USB memory and try again.



- The LCD panel of the system controller is a consumable part. To purchase the panel, contact the retailer or service center.

GPL/LGPL SOFTWARE LICENSE

The software included in this product contains copyrighted software that is licensed under the GPL/LGPL. You may obtain the complete Corresponding Source code from us for a period of three years after our last shipment of this product by sending email to help.cctv@samsung.com

If you want to obtain the complete Corresponding Source code in the physical medium such as CD-ROM, the cost of physically performing source distribution might be charged.

- GPL S/W
 - Linux Kernel, QT, Busybox, Sysvinit, dosfstools, Uboot, Bash, initutils
 - LGPL S/W
 - gLibc
-

GNU GENERAL PUBLIC LICENSE

Version 2, June 1991

Copyright (C)1989, 1991 Free Software Foundation, Inc.

51 Franklin Street, Fifth Floor, Boston, MA 02110-1301, USA

Everyone is permitted to copy and distribute verbatim copies of this license document, but changing it is not allowed.

Preamble

The licenses for most software are designed to take away your freedom to share and change it. By contrast, the GNU General Public License is intended to guarantee your freedom to share and change free software-- to make sure the software is free for all its users.

This General Public License applies to most of the Free Software Foundation's software and to any other program whose authors commit to using it. (Some other Free Software Foundation software is covered by the GNU Lesser General Public License instead.) You can apply it to your programs, too.

When we speak of free software, we are referring to freedom, not price.

Our General Public Licenses are designed to make sure that you have the freedom to distribute copies of free software (and charge for this service if you wish), that you receive source code or can get it if you want it, that you can change the software or use pieces of it in new free programs ; and that you know you can do these things.

To protect your rights, we need to make restrictions that forbid anyone to deny you these rights or to ask you to surrender the rights. These restrictions translate to certain responsibilities for you if you distribute copies of the software, or if you modify it.

For example, if you distribute copies of such a program, whether gratis or for a fee, you must give the recipients all the rights that you have.

You must make sure that they, too, receive or can get the source code. And you must show them these terms so they know their rights.

We protect your rights with two steps :

(1)copyright the software, and (2)offer you this license which gives you legal permission to copy, distribute and/or modify the software.

Also, for each author's protection and ours, we want to make certain that everyone understands that there is no warranty for this free software.

If the software is modified by someone else and passed on, we want its recipients to know that what they have is not the original, so that any problems introduced by others will not reflect on the original authors' reputations.

Finally, any free program is threatened constantly by software patents. We wish to avoid the danger that redistributors of a free program will individually obtain patent licenses, in effect making the program proprietary. To prevent this, we have made it clear that any patent must be licensed for everyone's free use or not licensed at all.

The precise terms and conditions for copying, distribution and modification follow.

TERMS AND CONDITIONS FOR COPYING, DISTRIBUTION AND MODIFICATION

Version 2, June 1991 Copyright (C) 1989, 1991 Free Software Foundation, Inc. 51 Franklin S

0. This License applies to any program or other work which contains a notice placed by the copyright holder saying it may be distributed under the terms of this General Public License. The "Program", below, refers to any such program or work, and a "work based on the Program" means either the Program or any derivative work under copyright law : that is to say, a work containing the Program or a portion of it, either verbatim or with modifications and/or translated into another language. (Hereinafter, translation is included without limitation in the term "modification".) Each licensee is addressed as "you".

Activities other than copying, distribution and modification are not covered by this License ; they are outside its scope. The act of running the Program is not restricted, and the output from the Program is covered only if its contents constitute a work based on the Program (independent of having been made by running the Program). Whether that is true depends on what the Program does.

1. You may copy and distribute verbatim copies of the Program's source code as you receive it, in any medium, provided that you conspicuously and appropriately publish on each copy an appropriate copyright notice and disclaimer of warranty; keep intact all the notices that refer to this License and to the absence of any warranty ; and give any other recipients of the Program a copy of this License along with the Program. You may charge a fee for the physical act of transferring a copy, and you may at your option offer warranty protection in exchange for a fee.
2. You may modify your copy or copies of the Program or any portion of it, thus forming a work based on the Program, and copy and distribute such modifications or work under the terms of Section 1 above, provided that you also meet all of these conditions :
 - a) You must cause the modified files to carry prominent notices stating that you changed the files and the date of any change.
 - b) You must cause any work that you distribute or publish, that in whole or in part contains or is derived from the Program or any part thereof, to be licensed as a whole at no charge to all third parties under the terms of this License.
 - c) If the modified program normally reads commands interactively when run, you must cause it, when started running for such interactive use in the most ordinary way, to print or display an announcement including an appropriate copyright notice and a notice that there is no warranty (or else, saying that you provide a warranty) and that users may redistribute the program under these conditions, and telling the user how to view a copy of this License. (Exception: if the Program itself is interactive but does not normally print such an announcement, your work based on the Program is not required to print an announcement.)

These requirements apply to the modified work as a whole. If identifiable sections of that work are not derived from the Program, and can be reasonably considered independent and separate works in themselves, then this License, and its terms, do not apply to those sections when you distribute them as separate works. But when you distribute the same sections as part of a whole which is a work based on the Program, the distribution of the whole must be on the terms of this License, whose permissions for other licensees extend to the entire whole, and thus to each and every part regardless of who wrote it.

Thus, it is not the intent of this section to claim rights or contest your rights to work written entirely by you ; rather, the intent is to exercise the right to control the distribution of derivative or collective works based on the Program. In addition, mere aggregation of another work not based on the Program with the Program (or with a work based on the Program) on a volume of a storage or distribution medium does not bring the other work under the scope of this License.

3. You may copy and distribute the Program (or a work based on it, under Section 2) in object code or executable form under the terms of Sections 1 and 2 above provided that you also do one of the following :

- a) Accompany it with the complete corresponding machine-readable source code, which must be distributed under the terms of Sections 1 and 2 above on a medium customarily used for software interchange ;
or,
- b) Accompany it with a written offer, valid for at least three years, to give any third party, for a charge no more than your cost of physically performing source distribution, a complete machine-readable copy of the corresponding source code, to be distributed under the terms of Sections 1 and 2 above on a medium

customarily used for software interchange ;
or,

- c) Accompany it with the information you received as to the offer to distribute corresponding source code. (This alternative is allowed only for noncommercial distribution and only if you received the program in object code or executable form with such an offer, in accord with Subsection b above.)

The source code for a work means the preferred form of the work for making modifications to it. For an executable work, complete source code means all the source code for all modules it contains, plus any associated interface definition files, plus the scripts used to control compilation and installation of the executable. However, as a special exception, the source code distributed need not include anything that is normally distributed (in either source or binary form) with the major components (compiler, kernel, and so on) of the operating system on which the executable runs, unless that component itself accompanies the executable.

If distribution of executable or object code is made by offering access to copy from a designated place, then offering equivalent access to copy the source code from the same place counts as distribution of the source code, even though third parties are not compelled to copy the source along with the object code.

4. You may not copy, modify, sublicense, or distribute the Program except as expressly provided under this License. Any attempt otherwise to copy, modify, sublicense or distribute the Program is void, and will automatically terminate your rights under this License.

However, parties who have received copies, or rights, from you under this License will not have their licenses terminated so long as such parties remain in full compliance.

5. You are not required to accept this License, since you have not signed it.

However, nothing else grants you permission to modify or distribute the Program or its derivative works.

These actions are prohibited by law if you do not accept this License. Therefore, by modifying or distributing the Program (or any work based on the Program), you indicate your acceptance of this License to do so, and all its terms and conditions for copying, distributing or modifying the Program or works based on it.

6. Each time you redistribute the Program (or any work based on the Program), the recipient automatically receives a license from the original licensor to copy, distribute or modify the Program subject to these terms and conditions. You may not impose any further restrictions on the recipients' exercise of the rights granted herein.

You are not responsible for enforcing compliance by third parties to this License.

7. If, as a consequence of a court judgment or allegation of patent infringement or for any other reason (not limited to patent issues), conditions are imposed on you (whether by court order, agreement or otherwise) that contradict the conditions of this License, they do not excuse you from the conditions of this License. If you cannot distribute so as to satisfy simultaneously your obligations under this License and any other pertinent obligations, then as a consequence you may not distribute the Program at all.

For example, if a patent license would not permit royalty-free redistribution of the Program by all those who receive copies directly or indirectly through you, then the only way you could satisfy both it and this License would be to refrain entirely from distribution of the Program.

If any portion of this section is held invalid or unenforceable under any particular circumstance,

the balance of the section is intended to apply and the section as a whole is intended to apply in other circumstances. It is not the purpose of this section to induce you to infringe any patents or other property right claims or to contest validity of any such claims; this section has the sole purpose of protecting the integrity of the free software distribution system, which is implemented by public license practices. Many people have made generous contributions to the wide range of software distributed through that system in reliance on consistent application of that system; it is up to the author/donor to decide if he or she is willing to distribute software through any other system and a licensee cannot impose that choice.

This section is intended to make thoroughly clear what is believed to be a consequence of the rest of this License.

8. If the distribution and/or use of the Program is restricted in certain countries either by patents or by copyrighted interfaces, the original copyright holder who places the Program under this License may add an explicit geographical distribution limitation excluding those countries, so that distribution is permitted only in or among countries not thus excluded. In such case, this License incorporates the limitation as if written in the body of this License.

9. The Free Software Foundation may publish revised and/or new versions of the General Public License from time to time. Such new versions will be similar in spirit to the present version, but may differ in detail to address new problems or concerns.

Each version is given a distinguishing version number. If the Program specifies a version number of this License which applies to it and "any later version", you have the option of following the terms and conditions either of that version or of any later version published by the Free Software Foundation. If the Program does not specify a version number of this License, you may choose

any version ever published by the Free Software Foundation.

10. If you wish to incorporate parts of the Program into other free programs whose distribution conditions are different, write to the author to ask for permission. For software which is copyrighted by the Free Software Foundation, write to the Free Software Foundation ; we sometimes make exceptions for this. Our decision will be guided by the two goals of preserving the free status of all derivatives of our free software and of promoting the sharing and reuse of software generally.

NO WARRANTY

11. BECAUSE THE PROGRAM IS LICENSED FREE OF CHARGE, THERE IS NO WARRANTY FOR THE PROGRAM, TO THE EXTENT PERMITTED BY APPLICABLE LAW. EXCEPT WHEN OTHERWISE STATED IN WRITING THE COPYRIGHT HOLDERS AND/OR OTHER PARTIES PROVIDE THE PROGRAM "AS IS" WITHOUT WARRANTY OF ANY KIND, EITHER EXPRESSED OR IMPLIED, INCLUDING, BUT NOT LIMITED TO, THE IMPLIED WARRANTIES OF MERCHANTABILITY AND FITNESS FOR A PARTICULAR PURPOSE. THE ENTIRE RISK AS TO THE QUALITY AND PERFORMANCE OF THE PROGRAM IS WITH YOU. SHOULD THE PROGRAM PROVE DEFECTIVE, YOU ASSUME THE COST OF ALL NECESSARY SERVICING, REPAIR OR CORRECTION.
12. IN NO EVENT UNLESS REQUIRED BY APPLICABLE LAW OR AGREED TO IN WRITING WILL ANY COPYRIGHT HOLDER, OR ANY OTHER PARTY WHO MAY MODIFY AND/OR REDISTRIBUTE DAMAGES, INCLUDING ANY GENERAL, SPECIAL, INCIDENTAL OR CONSEQUENTIAL DAMAGES ARISING OUT OF THE USE OR INABILITY TO USE THE PROGRAM

(INCLUDING BUT NOT LIMITED TO LOSS OF DATA OR DATA BEING RENDERED INACCURATE OR LOSSES SUSTAINED BY YOU OR THIRD PARTIES OR A FAILURE OF THE PROGRAM TO OPERATE WITH ANY OTHER PROGRAMS), EVEN IF SUCH HOLDER OR OTHER PARTY HAS BEEN ADVISED OF THE POSSIBILITY OF SUCH DAMAGES.

END OF TERMS AND CONDITIONS

How to Apply These Terms to Your New Programs

If you develop a new program, and you want it to be of the greatest possible use to the public, the best way to achieve this is to make it free software which everyone can redistribute and change under these terms.

To do so, attach the following notices to the program. It is safest to attach them to the start of each source file to most effectively convey the exclusion of warranty ; and each file should have at least the "copyright" line and a pointer to where the full notice is found.

one line to give the program's name and an idea of what it does.

Copyright (C)yyyy name of author

This program is free software ; you can redistribute it and/or modify it under the terms of the GNU General Public License as published by the Free Software Foundation ; either version 2 of the License, or (at your option) any later version.

This program is distributed in the hope that it will be useful, but WITHOUT ANY WARRANTY ; without even the implied warranty of MERCHANTABILITY or FITNESS FOR A PARTICULAR PURPOSE. See the GNU General Public License for more details.

You should have received a copy of the GNU General Public License along with this program ; if not, write to the Free Software Foundation, Inc.,51 Franklin Street, Fifth Floor, Boston, MA 02110-1301, USA.

Also add information on how to contact you by electronic and paper mail. If the program is interactive, make it output a short notice like this when it starts in an interactive mode :

Gnomovision version 69,

Copyright (C) year name of author

Gnomovision comes with ABSOLUTELY NO

WARRANTY ; for details type 'show w'. This is free software, and you are welcome to redistribute it under certain conditions ; type 'show c' for details.

The hypothetical commands 'show w' and 'show c' should show the appropriate parts of the General Public License. Of course, the commands you use may be called something other than 'show w' and 'show c' ; they could even be mouse-clicks or menu items-- whatever suits your program.

You should also get your employer (if you work as a programmer)or your school, if any, to sign a "copyright disclaimer" for the program,if necessary. Here is a sample ; alter the names:

Yoyodyne, Inc.,hereby disclaims all copyright interest in the program 'Gnomovision' (which makes passes at compilers) written by James Hacker.

signature of Ty Coon, 1 April 1989 Ty Coon,
President of Vice This General Public License
does not permit incorporating your program
into proprietary programs. If your program is a
subroutine library, you may consider it more useful
to permit linking proprietary applications with the
library. If this is what you want to do, use the **GNU
Lesser General Public License** instead of this
License.

GNU GENERAL PUBLIC LICENSE

Version 3, 29 June 2007

Copyright © 2007 Free Software Foundation, Inc.
<<http://fsf.org/>>

Everyone is permitted to copy and distribute verbatim copies of this license document, but changing it is not allowed.

Preamble

The GNU General Public License is a free, copyleft license for software and other kinds of works. The licenses for most software and other practical works are designed to take away your freedom to share and change the works. By contrast, the GNU General Public License is intended to guarantee your freedom to share and change all versions of a program--to make sure it remains free software for all its users.

We, the Free Software Foundation, use the GNU General Public License for most of our software; it applies also to any other work released this way by its authors.

You can apply it to your programs, too.

When we speak of free software, we are referring to freedom, not price. Our General Public Licenses are designed to make sure that you have the freedom to distribute copies of free software (and charge for them if you wish), that you receive source code or can get it if you want it, that you can change the software or use pieces of it in new free programs, and that you know you can do these things.

To protect your rights, we need to prevent others from denying you these rights or asking you to surrender the rights. Therefore, you have certain responsibilities if you distribute copies of the software, or if you modify it: responsibilities to respect the freedom of others.

For example, if you distribute copies of such a program, whether gratis or for a fee, you must

pass on to the recipients the same freedoms that you received. You must make sure that they, too, receive or can get the source code. And you must show them these terms so they know their rights.

Developers that use the GNU GPL protect your rights with two steps: (1) assert copyright on the software, and (2) offer you this License giving you legal permission to copy, distribute and/or modify it.

For the developers' and authors' protection, the GPL clearly explains that there is no warranty for this free software. For both users' and authors' sake, the GPL requires that modified versions be marked as changed, so that their problems will not be attributed erroneously to authors of previous versions.

Some devices are designed to deny users access to install or run modified versions of the software inside them, although the manufacturer can do so. This is fundamentally incompatible with the aim of protecting users' freedom to change the software. The systematic pattern of such abuse occurs in the area of products for individuals to use, which is precisely where it is most unacceptable. Therefore, we have designed this version of the GPL to prohibit the practice for those products. If such problems arise substantially in other domains, we stand ready to extend this provision to those domains in future versions of the GPL, as needed to protect the freedom of users.

Finally, every program is threatened constantly by software patents. States should not allow patents to restrict development and use of software on general-purpose computers, but in those that do, we wish to avoid the special danger that patents applied to a free program could make it effectively proprietary. To prevent this, the GPL assures that patents cannot be used to render the program non-free.

The precise terms and conditions for copying, distribution and modification follow.

TERMS AND CONDITIONS

0. Definitions.

"This License" refers to version 3 of the GNU General Public License.

"Copyright" also means copyright-like laws that apply to other kinds of works, such as semiconductor masks.

"The Program" refers to any copyrightable work licensed under this License. Each licensee is addressed as "you". "Licensees" and "recipients" may be individuals or organizations.

To "modify" a work means to copy from or adapt all or part of the work in a fashion requiring copyright permission, other than the making of an exact copy. The resulting work is called a "modified version" of the earlier work or a work "based on" the earlier work.

A "covered work" means either the unmodified Program or a work based on the Program.

To "propagate" a work means to do anything with it that, without permission, would make you directly or secondarily liable for infringement under applicable copyright law, except executing it on a computer or modifying a private copy. Propagation includes copying, distribution (with or without modification), making available to the public, and in some countries other activities as well.

To "convey" a work means any kind of propagation that enables other parties to make or receive copies. Mere interaction with a user through a computer network, with no transfer of a copy, is not conveying.

An interactive user interface displays "Appropriate Legal Notices" to the extent that it includes a convenient and prominently visible feature that (1) displays an appropriate copyright notice, and (2) tells the user that there is no warranty for the work (except to the extent that warranties are provided), that licensees may convey the work under this License, and how to view a copy of this License. If the interface presents a list of user commands or options, such as a menu, a prominent item in the list meets this criterion.

1. Source Code.

The “source code” for a work means the preferred form of the work for making modifications to it. “Object code” means any non-source form of a work.

A “Standard Interface” means an interface that either is an official standard defined by a recognized standards body, or, in the case of interfaces specified for a particular programming language, one that is widely used among developers working in that language.

The “System Libraries” of an executable work include anything, other than the work as a whole, that (a) is included in the normal form of packaging a Major Component, but which is not part of that Major Component, and (b) serves only to enable use of the work with that Major Component, or to implement a Standard Interface for which an implementation is available to the public in source code form. A “Major Component”, in this context, means a major essential component (kernel, window system, and so on) of the specific operating system (if any) on which the executable work runs, or a compiler used to produce the work, or an object code interpreter used to run it.

The “Corresponding Source” for a work in object code form means all the source code needed to generate, install, and (for an executable work) run the object code and to modify the work, including scripts to control those activities. However, it does not include the work’s System Libraries, or general-purpose tools or generally available free programs which are used unmodified in performing those activities but which are not part of the work. For example, Corresponding Source includes interface definition files associated with source files for the work, and the source code for shared libraries and dynamically linked subprograms that the work is specifically designed to require, such as by intimate data communication or control flow between those subprograms and other parts of the work.

The Corresponding Source need not include anything that users can regenerate automatically from other parts of the Corresponding Source.

The Corresponding Source for a work in source code form is that same work.

2. Basic Permissions.

All rights granted under this License are granted for the term of copyright on the Program, and are irrevocable provided the stated conditions are met. This License explicitly affirms your unlimited permission to run the unmodified Program. The output from running a covered work is covered by this License only if the output, given its content, constitutes a covered work. This License acknowledges your rights of fair use or other equivalent, as provided by copyright law.

You may make, run and propagate covered works that you do not convey, without conditions so long as your license otherwise remains in force. You may convey covered works to others for the sole purpose of having them make modifications exclusively for you, or provide you with facilities for running those works, provided that you comply with the terms of this License in conveying all material for which you do not control copyright. Those thus making or running the covered works for you must do so exclusively on your behalf, under your direction and control, on terms that prohibit them from making any copies of your copyrighted material outside their relationship with you.

Conveying under any other circumstances is permitted solely under the conditions stated below. Sublicensing is not allowed; section 10 makes it unnecessary.

3. Protecting Users' Legal Rights From Anti-Circumvention Law.

No covered work shall be deemed part of an effective technological measure under any applicable law fulfilling obligations under article 11 of the WIPO copyright treaty adopted on 20 December 1996, or similar laws prohibiting or restricting circumvention of such measures.

When you convey a covered work, you waive any legal power to forbid circumvention of technological measures to the extent such circumvention is effected by exercising rights under this License with respect to the covered work, and you disclaim any intention to limit operation or modification of the work as a means of enforcing, against the work’s users, your

or third parties' legal rights to forbid circumvention of technological measures.

4. Conveying Verbatim Copies.

You may convey verbatim copies of the Program's source code as you receive it, in any medium, provided that you conspicuously and appropriately publish on each copy an appropriate copyright notice; keep intact all notices stating that this License and any non-permissive terms added in accord with section 7 apply to the code; keep intact all notices of the absence of any warranty; and give all recipients a copy of this License along with the Program.

You may charge any price or no price for each copy that you convey, and you may offer support or warranty protection for a fee.

5. Conveying Modified Source Versions.

You may convey a work based on the Program, or the modifications to produce it from the Program, in the form of source code under the terms of section 4, provided that you also meet all of these conditions:

- a) The work must carry prominent notices stating that you modified it, and giving a relevant date.
- b) The work must carry prominent notices stating that it is released under this License and any conditions added under section 7. This requirement modifies the requirement in section 4 to "keep intact all notices".
- c) You must license the entire work, as a whole, under this License to anyone who comes into possession of a copy. This License will therefore apply, along with any applicable section 7 additional terms, to the whole of the work, and all its parts, regardless of how they are packaged. This License gives no permission to license the work in any other way, but it does not invalidate such permission if you have separately received it.
- d) If the work has interactive user interfaces, each must display Appropriate Legal Notices; however, if the Program has interactive interfaces that do not display Appropriate Legal Notices, your work need not make them do so.

A compilation of a covered work with other separate

and independent works, which are not by their nature extensions of the covered work, and which are not combined with it such as to form a larger program, in or on a volume of a storage or distribution medium, is called an "aggregate" if the compilation and its resulting copyright are not used to limit the access or legal rights of the compilation's users beyond what the individual works permit. Inclusion of a covered work in an aggregate does not cause this License to apply to the other parts of the aggregate.

6. Conveying Non-Source Forms.

You may convey a covered work in object code form under the terms of sections 4 and 5, provided that you also convey the machine-readable Corresponding Source under the terms of this License, in one of these ways:

- a) Convey the object code in, or embodied in, a physical product (including a physical distribution medium), accompanied by the Corresponding Source fixed on a durable physical medium customarily used for software interchange.
- b) Convey the object code in, or embodied in, a physical product (including a physical distribution medium), accompanied by a written offer, valid for at least three years and valid for as long as you offer spare parts or customer support for that product model, to give anyone who possesses the object code either (1) a copy of the Corresponding Source for all the software in the product that is covered by this License, on a durable physical medium customarily used for software interchange, for a price no more than your reasonable cost of physically performing this conveying of source, or (2) access to copy the Corresponding Source from a network server at no charge.
- c) Convey individual copies of the object code with a copy of the written offer to provide the corresponding Source. This alternative is allowed only occasionally and noncommercially, and only if you received the object code with such an offer, in accord with subsection 6b.
- d) Convey the object code by offering access from a designated place (gratis or for a charge), and offer equivalent access to the Corresponding Source

in the same way through the same place at no further charge. You need not require recipients to copy the Corresponding Source along with the object code. If the place to copy the object code is a network server, the Corresponding Source may be on a different server (operated by you or a third party) that supports equivalent copying facilities, provided you maintain clear directions next to the object code saying where to find the Corresponding Source. Regardless of what server hosts the Corresponding Source, you remain obligated to ensure that it is available for as long as needed to satisfy these requirements.

- e) Convey the object code using peer-to-peer transmission, provided you inform other peers where the object code and Corresponding Source of the work are being offered to the general public at no charge under subsection 6d.

A separable portion of the object code, whose source code is excluded from the Corresponding Source as a System Library, need not be included in conveying the object code work.

A "User Product" is either (1) a "consumer product", which means any tangible personal property which is normally used for personal, family, or household purposes, or (2) anything designed or sold for incorporation into a dwelling. In determining whether a product is a consumer product, doubtful cases shall be resolved in favor of coverage. For a particular product received by a particular user, "normally used" refers to a typical or common use of that class of product, regardless of the status of the particular user or of the way in which the particular user actually uses, or expects or is expected to use, the product. A product is a consumer product regardless of whether the product has substantial commercial, industrial or non-consumer uses, unless such uses represent the only significant mode of use of the product.

"Installation Information" for a User Product means any methods, procedures, authorization keys, or other information required to install and execute modified versions of a covered work in that User Product from a modified version of its Corresponding Source. The information must suffice to ensure that

the continued functioning of the modified object code is in no case prevented or interfered with solely because modification has been made.

If you convey an object code work under this section in, or with, or specifically for use in, a User Product, and the conveying occurs as part of a transaction in which the right of possession and use of the User Product is transferred to the recipient in perpetuity or for a fixed term (regardless of how the transaction is characterized), the Corresponding Source conveyed under this section must be accompanied by the Installation Information. But this requirement does not apply if neither you nor any third party retains the ability to install modified object code on the User Product (for example, the work has been installed in ROM).

The requirement to provide Installation Information does not include a requirement to continue to provide support service, warranty, or updates for a work that has been modified or installed by the recipient, or for the User Product in which it has been modified or installed. Access to a network may be denied when the modification itself materially and adversely affects the operation of the network or violates the rules and protocols for communication across the network.

Corresponding Source conveyed, and Installation Information provided, in accord with this section must be in a format that is publicly documented (and with an implementation available to the public in source code form), and must require no special password or key for unpacking, reading or copying.

7. Additional Terms.

"Additional permissions" are terms that supplement the terms of this License by making exceptions from one or more of its conditions. Additional permissions that are applicable to the entire Program shall be treated as though they were included in this License, to the extent that they are valid under applicable law. If additional permissions apply only to part of the Program, that part may be used separately under those permissions, but the entire Program remains governed by this License without regard to the additional permissions.

When you convey a copy of a covered work, you may at your option remove any additional permissions from that copy, or from any part of it. (Additional permissions may be written to require their own removal in certain cases when you modify the work.) You may place additional permissions on material, added by you to a covered work, for which you have or can give appropriate copyright permission.

Notwithstanding any other provision of this License, for material you add to a covered work, you may (if authorized by the copyright holders of that material) supplement the terms of this License with terms:

- a) Disclaiming warranty or limiting liability differently from the terms of sections 15 and 16 of this License; or
- b) Requiring preservation of specified reasonable legal notices or author attributions in that material or in the Appropriate Legal Notices displayed by works containing it; or
- c) Prohibiting misrepresentation of the origin of that material, or requiring that modified versions of such material be marked in reasonable ways as different from the original version; or
- d) Limiting the use for publicity purposes of names of licensors or authors of the material; or
- e) Declining to grant rights under trademark law for use of some trade names, trademarks, or service marks; or
- f) Requiring indemnification of licensors and authors of that material by anyone who conveys the material (or modified versions of it) with contractual assumptions of liability to the recipient, for any liability that these contractual assumptions directly impose on those licensors and authors.

All other non-permissive additional terms are considered “further restrictions” within the meaning of section 10. If the Program as you received it, or any part of it, contains a notice stating that it is governed by this License along with a term that is a further restriction, you may remove that term. If a license document contains a further restriction but permits relicensing or conveying under this License, you may add to a covered work material governed by

the terms of that license document, provided that the further restriction does not survive such relicensing or conveying.

If you add terms to a covered work in accord with this section, you must place, in the relevant source files, a statement of the additional terms that apply to those files, or a notice indicating where to find the applicable terms.

Additional terms, permissive or non-permissive, may be stated in the form of a separately written license, or stated as exceptions; the above requirements apply either way.

8. Termination.

You may not propagate or modify a covered work except as expressly provided under this License. Any attempt otherwise to propagate or modify it is void, and will automatically terminate your rights under this License (including any patent licenses granted under the third paragraph of section 11).

However, if you cease all violation of this License, then your license from a particular copyright holder is reinstated (a) provisionally, unless and until the copyright holder explicitly and finally terminates your license, and (b) permanently, if the copyright holder fails to notify you of the violation by some reasonable means prior to 60 days after the cessation.

Moreover, your license from a particular copyright holder is reinstated permanently if the copyright holder notifies you of the violation by some reasonable means, this is the first time you have received notice of violation of this License (for any work) from that copyright holder, and you cure the violation prior to 30 days after your receipt of the notice.

Termination of your rights under this section does not terminate the licenses of parties who have received copies or rights from you under this License. If your rights have been terminated and not permanently reinstated, you do not qualify to receive new licenses for the same material under section 10.

9. Acceptance Not Required for Having Copies.

You are not required to accept this License in order to receive or run a copy of the Program. Ancillary

propagation of a covered work occurring solely as a consequence of using peer-to-peer transmission to receive a copy likewise does not require acceptance. However, nothing other than this License grants you permission to propagate or modify any covered work. These actions infringe copyright if you do not accept this License. Therefore, by modifying or propagating a covered work, you indicate your acceptance of this License to do so.

10. Automatic Licensing of Downstream Recipients.

Each time you convey a covered work, the recipient automatically receives a license from the original licensors, to run, modify and propagate that work, subject to this License. You are not responsible for enforcing compliance by third parties with this License.

An “entity transaction” is a transaction transferring control of an organization, or substantially all assets of one, or subdividing an organization, or merging organizations. If propagation of a covered work results from an entity transaction, each party to that transaction who receives a copy of the work also receives whatever licenses to the work the party's predecessor in interest had or could give under the previous paragraph, plus a right to possession of the Corresponding Source of the work from the predecessor in interest, if the predecessor has it or can get it with reasonable efforts.

You may not impose any further restrictions on the exercise of the rights granted or affirmed under this License. For example, you may not impose a license fee, royalty, or other charge for exercise of rights granted under this License, and you may not initiate litigation (including a cross-claim or counterclaim in a lawsuit) alleging that any patent claim is infringed by making, using, selling, offering for sale, or importing the Program or any portion of it.

11. Patents.

A “contributor” is a copyright holder who authorizes use under this License of the Program or a work on which the Program is based. The work thus licensed is called the contributor's “contributor version”.

A contributor's “essential patent claims” are all patent claims owned or controlled by the contributor, whether already acquired or hereafter acquired, that would be infringed by some manner, permitted by this License, of making, using, or selling its contributor version, but do not include claims that would be infringed only as a consequence of further modification of the contributor version. For purposes of this definition, “control” includes the right to grant patent sublicenses in a manner consistent with the requirements of this License.

Each contributor grants you a non-exclusive, worldwide, royalty-free patent license under the contributor's essential patent claims, to make, use, sell, offer for sale, import and otherwise run, modify and propagate the contents of its contributor version.

In the following three paragraphs, a “patent license” is any express agreement or commitment, however denominated, not to enforce a patent (such as an express permission to practice a patent or covenant not to sue for patent infringement). To “grant” such a patent license to a party means to make such an agreement or commitment not to enforce a patent against the party.

If you convey a covered work, knowingly relying on a patent license, and the Corresponding Source of the work is not available for anyone to copy, free of charge and under the terms of this License, through a publicly available network server or other readily accessible means, then you must either (1) cause the Corresponding Source to be so available, or (2) arrange to deprive yourself of the benefit of the patent license for this particular work, or (3) arrange, in a manner consistent with the requirements of this License, to extend the patent license to downstream recipients. “Knowingly relying” means you have actual knowledge that, but for the patent license, your conveying the covered work in a country, or your recipient's use of the covered work in a country, would infringe one or more identifiable patents in that country that you have reason to believe are valid.

If, pursuant to or in connection with a single transaction or arrangement, you convey, or propagate by procuring conveyance of, a covered

work, and grant a patent license to some of the parties receiving the covered work authorizing them to use, propagate, modify or convey a specific copy of the covered work, then the patent license you grant is automatically extended to all recipients of the covered work and works based on it.

A patent license is “discriminatory” if it does not include within the scope of its coverage, prohibits the exercise of, or is conditioned on the non-exercise of one or more of the rights that are specifically granted under this License. You may not convey a covered work if you are a party to an arrangement with a third party that is in the business of distributing software, under which you make payment to the third party based on the extent of your activity of conveying the work, and under which the third party grants, to any of the parties who would receive the covered work from you, a discriminatory patent license

- (a) in connection with copies of the covered work conveyed by you (or copies made from those copies), or
- (b) primarily for and in connection with specific products or compilations that contain the covered work, unless you entered into that arrangement, or that patent license was granted, prior to 28 March 2007.

Nothing in this License shall be construed as excluding or limiting any implied license or other defenses to infringement that may otherwise be available to you under applicable patent law.

12. No Surrender of Others' Freedom.

If conditions are imposed on you (whether by court order, agreement or otherwise) that contradict the conditions of this License, they do not excuse you from the conditions of this License. If you cannot convey a covered work so as to satisfy simultaneously your obligations under this License and any other pertinent obligations, then as a consequence you may not convey it at all. For example, if you agree to terms that obligate you to collect a royalty for further conveying from those to whom you convey the Program, the only way you could satisfy both those terms and this License would be to refrain entirely from conveying the Program.

13. Use with the GNU Affero General Public License.

Notwithstanding any other provision of this License, you have permission to link or combine any covered work with a work licensed under version 3 of the GNU Affero General Public License into a single combined work, and to convey the resulting work. The terms of this License will continue to apply to the part which is the covered work, but the special requirements of the GNU Affero General Public License, section 13, concerning interaction through a network will apply to the combination as such.

14. Revised Versions of this License.

The Free Software Foundation may publish revised and/ or new versions of the GNU General Public License from time to time. Such new versions will be similar in spirit to the present version, but may differ in detail to address new problems or concerns.

Each version is given a distinguishing version number. If the Program specifies that a certain numbered version of the GNU General Public License “or any later version” applies to it, you have the option of following the terms and conditions either of that numbered version or of any later version published by the Free Software Foundation. If the Program does not specify a version number of the GNU General Public License, you may choose any version ever published by the Free Software Foundation.

If the Program specifies that a proxy can decide which future versions of the GNU General Public License can be used, that proxy’s public statement of acceptance of a version permanently authorizes you to choose that version for the Program.

Later license versions may give you additional or different permissions. However, no additional obligations are imposed on any author or copyright holder as a result of your choosing to follow a later version.

15. Disclaimer of Warranty.

THERE IS NO WARRANTY FOR THE PROGRAM, TO THE EXTENT PERMITTED BY APPLICABLE LAW. EXCEPT WHEN OTHERWISE STATED IN WRITING THE COPYRIGHT HOLDERS AND/OR

OTHER PARTIES PROVIDE THE PROGRAM "AS IS" WITHOUT WARRANTY OF ANY KIND, EITHER EXPRESSED OR IMPLIED, INCLUDING, BUT NOT LIMITED TO, THE IMPLIED WARRANTIES OF MERCHANTABILITY AND FITNESS FOR A PARTICULAR PURPOSE. THE ENTIRE RISK AS TO THE QUALITY AND PERFORMANCE OF THE PROGRAM IS WITH YOU. SHOULD THE PROGRAM PROVE DEFECTIVE, YOU ASSUME THE COST OF ALL NECESSARY SERVICING, REPAIR OR CORRECTION.

16. Limitation of Liability.

IN NO EVENT UNLESS REQUIRED BY APPLICABLE LAW OR AGREED TO IN WRITING WILL ANY COPYRIGHT HOLDER, OR ANY OTHER PARTY WHO MODIFIES AND/OR CONVEYS THE PROGRAM AS PERMITTED ABOVE, BE LIABLE TO YOU FOR DAMAGES, INCLUDING ANY GENERAL, SPECIAL, INCIDENTAL OR CONSEQUENTIAL DAMAGES ARISING OUT OF THE USE OR INABILITY TO USE THE PROGRAM (INCLUDING BUT NOT LIMITED TO LOSS OF DATA OR DATA BEING RENDERED INACCURATE OR LOSSES SUSTAINED BY YOU OR THIRD PARTIES OR A FAILURE OF THE PROGRAM TO OPERATE WITH ANY OTHER PROGRAMS), EVEN IF SUCH HOLDER OR OTHER PARTY HAS BEEN ADVISED OF THE POSSIBILITY OF SUCH DAMAGES.

17. Interpretation of Sections 15 and 16.

If the disclaimer of warranty and limitation of liability provided above cannot be given local legal effect according to their terms, reviewing courts shall apply local law that most closely approximates an absolute waiver of all civil liability in connection with the Program, unless a warranty or assumption of liability accompanies a copy of the Program in return for a fee.

END OF TERMS AND CONDITIONS

GNU LESSER GENERAL PUBLIC LICENSE

Version 2.1, February 1999

Copyright (C) 1991, 1999 Free Software Foundation, Inc. 51 Franklin Street, Fifth Floor, Boston, MA 02110-1301

USA Everyone is permitted to copy and distribute verbatim copies of this license document, but changing it is not allowed.

[This is the first released version of the Lesser GPL. It also counts as the successor of the GNU Library Public License, version 2, hence the version number 2.1.]

Preamble

The licenses for most software are designed to take away your freedom to share and change it. By contrast, the GNU General Public Licenses are intended to guarantee your freedom to share and change free software to make sure the software is free for all its users.

This license, the Lesser General Public License, applies to some specially designated software packages-typically libraries-of the Free Software Foundation and other authors who decide to use it. You can use it too, but we suggest you first think carefully about whether this license or the ordinary General Public License is the better strategy to use in any particular case, based on the explanations below.

When we speak of free software, we are referring to freedom of use, not price. Our General Public Licenses are designed to make sure that you have the freedom to distribute copies of free software (and charge for this service if you wish); that you receive source code or can get it if you want it; that you can change the software and use pieces of it in new free programs; and that you are informed that you can do these things.

To protect your rights, we need to make restrictions that forbid distributors to deny you these rights or to ask you to surrender these rights. These restrictions translate to certain responsibilities for you if you distribute copies of the library or if you modify it.

For example, if you distribute copies of the library, whether gratis or for a fee, you must give the recipients all the rights that we gave you. You must make sure that they, too, receive or can get the source code. If you link other code with the library, you must provide complete object files to the recipients, so that they can relink them with the library after making changes to the library and recompiling it. And you must show them these terms so they know their rights.

We protect your rights with a two-step method: (1) we copyright the library, and (2) we offer you this license, which gives you legal permission to copy, distribute and/or modify the library.

To protect each distributor, we want to make it very clear that there is no warranty for the free library. Also, if the library is modified by someone else and passed on, the recipients should know that what they have is not the original version, so that the original author's reputation will not be affected by problems that might be introduced by others.

Finally, software patents pose a constant threat to the existence of any free program. We wish to make sure that a company cannot effectively restrict the users of a free program by obtaining a restrictive license from a patent holder. Therefore, we insist that any patent license obtained for a version of the library must be consistent with the full freedom of use specified in this license.

Most GNU software, including some libraries, is covered by the ordinary GNU General Public License. This license, the GNU Lesser General Public License, applies to certain designated libraries, and is quite different from the ordinary

General Public License. We use this license for certain libraries in order to permit linking those libraries into non-free programs.

When a program is linked with a library, whether statically or using a shared library, the combination of the two is legally speaking a combined work, a derivative of the original library. The ordinary General Public License therefore permits such linking only if the entire combination fits its criteria of freedom. The Lesser General Public License permits more lax criteria for linking other code with the library.

We call this license the "Lesser" General Public License because it does Less to protect the user's freedom than the ordinary General Public License. It also provides other free software developers Less of an advantage over competing non-free programs. These disadvantages are the reason we use the ordinary General Public License for many libraries. However, the Lesser license provides advantages in certain special circumstances.

For example, on rare occasions, there may be a special need to encourage the widest possible use of a certain library, so that it becomes a de-facto standard. To achieve this, non-free programs must be allowed to use the library. A more frequent case is that a free library does the same job as widely used non-free libraries. In this case, there is little to gain by limiting the free library to free software only, so we use the Lesser General Public License.

In other cases, permission to use a particular library in non-free programs enables a greater number of people to use a large body of free software. For example, permission to use the GNU C Library in non-free programs enables many more people to use the whole GNU operating system, as well as its variant, the GNU/ Linux operating system.

Although the Lesser General Public License is Less protective of the users' freedom, it does ensure that the user of a program that is linked with the

Library has the freedom and the wherewithal to run that program using a modified version of the Library.

The precise terms and conditions for copying, distribution and modification follow. Pay close attention to the difference between a “work based on the library” and a “work that uses the library”. The former contains code derived from the library, whereas the latter must be combined with the library in order to run.

TERMS AND CONDITIONS FOR COPYING, DISTRIBUTION AND MODIFICATION

0. This License Agreement applies to any software library or other program which contains a notice placed by the copyright holder or other authorized party saying it may be distributed under the terms of this Lesser General Public License (also called “this License”). Each licensee is addressed as “you”.

A “library” means a collection of software functions and/ or data prepared so as to be conveniently linked with application programs (which use some of those functions and data) to form executables.

The “Library”, below, refers to any such software library or work which has been distributed under these terms. A “work based on the Library” means either the Library or any derivative work under copyright law: that is to say, a work containing the Library or a portion of it, either verbatim or with modifications and/or translated straightforwardly into another language. (Hereinafter, translation is included without limitation in the term “modification”.)

“Source code” for a work means the preferred form of the work for making modifications to it. For a library, complete source code means all the source code for all modules it contains, plus any associated interface definition files, plus the scripts used to control compilation and installation of the library.

Activities other than copying, distribution and modification are not covered by this License; they are outside its scope. The act of running a program using the Library is not restricted, and output from such a program is covered only if its contents constitute a work based on the Library (independent of the use of the Library in a tool for writing it). Whether that is true depends on what the Library does and what the program that uses the Library does.

1. You may copy and distribute verbatim copies of the Library’s complete source code as you receive it, in any medium, provided that you conspicuously and appropriately publish on each copy an appropriate copyright notice and disclaimer of warranty; keep intact all the notices that refer to this License and to the absence of any warranty; and distribute a copy of this License along with the Library.

You may charge a fee for the physical act of transferring a copy, and you may at your option offer warranty protection in exchange for a fee.

2. You may modify your copy or copies of the Library or any portion of it, thus forming a work based on the Library, and copy and distribute such modifications or work under the terms of Section 1 above, provided that you also meet all of these conditions:

a) The modified work must itself be a software library. b) You must cause the files modified to carry prominent notices stating that you changed the files and the date of any change. c) You must cause the whole of the work to be licensed at no charge to all third parties under the terms of this License. d) If a facility in the modified Library refers to a function or a table of data to be supplied by an application program that uses the facility, other than as an argument passed when the facility is invoked, then you must make a good faith effort to ensure that, in the event an application does not supply such function or table, the facility still operates, and performs whatever part of its

purpose remains meaningful. (For example, a function in a library to compute square roots has a purpose that is entirely well-defined independent of the application. Therefore, Subsection 2d requires that any application-supplied function or table used by this function must be optional: if the application does not supply it, the square root function must still compute square roots.) These requirements apply to the modified work as a whole. If identifiable sections of that work are not derived from the Library, and can be reasonably considered independent and separate works in themselves, then this License, and its terms, do not apply to those sections when you distribute them as separate works. But when you distribute the same sections as part of a whole which is a work based on the Library, the distribution of the whole must be on the terms of this License, whose permissions for other licensees extend to the entire whole, and thus to each and every part regardless of who wrote it.

Thus, it is not the intent of this section to claim rights or contest your rights to work written entirely by you; rather, the intent is to exercise the right to control the distribution of derivative or collective works based on the Library.

In addition, mere aggregation of another work not based on the Library with the Library (or with a work based on the Library) on a volume of a storage or distribution medium does not bring the other work under the scope of this License.

3. You may opt to apply the terms of the ordinary GNU General Public License instead of this License to a given copy of the Library. To do this, you must alter all the notices that refer to this License, so that they refer to the ordinary GNU General Public License, version 2, instead of to this License. (If a newer version than version 2 of the ordinary GNU General Public License has appeared, then you can specify that version instead if you wish.) Do not make any other change in these notices.

Once this change is made in a given copy, it is irreversible for that copy, so the ordinary GNU General Public License applies to all subsequent copies and derivative works made from that copy.

This option is useful when you wish to copy part of the code of the Library into a program that is not a library.

4. You may copy and distribute the Library (or a portion or derivative of it, under Section 2) in object code or executable form under the terms of Sections 1 and 2 above provided that you accompany it with the complete corresponding machine-readable source code, which must be distributed under the terms of Sections 1 and 2 above on a medium customarily used for software interchange.

If distribution of object code is made by offering access to copy from a designated place, then offering equivalent access to copy the source code from the same place satisfies the requirement to distribute the source code, even though third parties are not compelled to copy the source along with the object code.

5. A program that contains no derivative of any portion of the Library, but is designed to work with the Library by being compiled or linked with it, is called a “work that uses the Library”. Such a work, in isolation, is not a derivative work of the Library, and therefore falls outside the scope of this License.

However, linking a “work that uses the Library” with the Library creates an executable that is a derivative of the Library (because it contains portions of the Library), rather than a “work that uses the library”.

The executable is therefore covered by this License. Section 6 states terms for distribution of such executables.

When a “work that uses the Library” uses material from a header file that is part of the Library, the object code for the work may be a derivative work

of the Library even though the source code is not. Whether this is true is especially significant if the work can be linked without the Library, or if the work is itself a library. The threshold for this to be true is not precisely defined by law.

If such an object file uses only numerical parameters, data structure layouts and accessors, and small macros and small inline functions (ten lines or less in length), then the use of the object file is unrestricted, regardless of whether it is legally a derivative work. (Executables containing this object code plus portions of the Library will still fall under Section 6.)

Otherwise, if the work is a derivative of the Library, you may distribute the object code for the work under the terms of Section 6. Any executables containing that work also fall under Section 6, whether or not they are linked directly with the Library itself.

6. As an exception to the Sections above, you may also combine or link a “work that uses the Library” with the Library to produce a work containing portions of the Library, and distribute that work under terms of your choice, provided that the terms permit modification of the work for the customer’s own use and reverse engineering for debugging such modifications.

You must give prominent notice with each copy of the work that the Library is used in it and that the Library and its use are covered by this License. You must supply a copy of this License. If the work during execution displays copyright notices, you must include the copyright notice for the Library among them, as well as a reference directing the user to the copy of this License. Also, you must do one of these things:

a) Accompany the work with the complete corresponding machine-readable source code for the Library including whatever changes were used in the work (which must be distributed under Sections 1 and 2 above); and, if the work

is an executable linked with the Library, with the complete machine readable “work that uses the Library”, as object code and/or source code, so that the user can modify the Library and then relink to produce a modified executable containing the modified Library. (It is understood that the user who changes the contents of definitions files in the Library will not necessarily be able to recompile the application to use the modified definitions.)

b) Use a suitable shared library mechanism for linking with the Library. A suitable mechanism is one that

(1) uses at run time a copy of the library already present on the user’s computer system, rather than copying library functions into the executable, and (2) will operate properly with a modified version of the library, if the user installs one, as long as the modified version is interface-compatible with the version that the work was made with.

c) Accompany the work with a written offer, valid for at least three years, to give the same user the materials specified in Subsection 6a, above, for a charge no more than the cost of performing this distribution.

d) If distribution of the work is made by offering access to copy from a designated place, offer equivalent access to copy the above specified materials from the same place.

e) Verify that the user has already received a copy of these materials or that you have already sent this user a copy.

For an executable, the required form of the “work that uses the Library” must include any data and utility programs needed for reproducing the executable from it. However, as a special exception, the materials to be distributed need not include anything that is normally distributed (in either source or binary form) with the major components (compiler, kernel, and so on) of the operating system on which the executable runs,

unless that component itself accompanies the executable.

It may happen that this requirement contradicts the license restrictions of other proprietary libraries that do not normally accompany the operating system. Such a contradiction means you cannot use both them and the Library together in an executable that you distribute.

7. You may place library facilities that are a work based on the Library side-by-side in a single library together with other library facilities not covered by this License, and distribute such a combined library, provided that the separate distribution of the work based on the Library and of the other library facilities is otherwise permitted, and provided that you do these two things:
 - a) Accompany the combined library with a copy of the same work based on the Library, uncombined with any other library facilities. This must be distributed under the terms of the Sections above.
 - b) Give prominent notice with the combined library of the fact that part of it is a work based on the Library, and explaining where to find the accompanying uncombined form of the same work.
8. You may not copy, modify, sublicense, link with, or distribute the Library except as expressly provided under this License. Any attempt otherwise to copy, modify, sublicense, link with, or distribute the Library is void, and will automatically terminate your rights under this License. However, parties who have received copies, or rights, from you under this License will not have their licenses terminated so long as such parties remain in full compliance.
9. You are not required to accept this License, since you have not signed it. However, nothing else grants you permission to modify or distribute the Library or its derivative works.

These actions are prohibited by law if you do not accept this License. Therefore, by modifying or distributing the Library (or any work based on the Library), you indicate your acceptance of this License to do so, and all its terms and conditions for copying, distributing or modifying the Library or works based on it.

10. Each time you redistribute the Library (or any work based on the Library), the recipient automatically receives a license from the original licensor to copy, distribute, link with or modify the Library subject to these terms and conditions. You may not impose any further restrictions on the recipients' exercise of the rights granted herein. You are not responsible for enforcing compliance by third parties with this License.
11. If, as a consequence of a court judgment or allegation of patent infringement or for any other reason (not limited to patent issues), conditions are imposed on you (whether by court order, agreement or otherwise) that contradict the conditions of this License, they do not excuse you from the conditions of this License. If you cannot distribute so as to satisfy simultaneously your obligations under this License and any other pertinent obligations, then as a consequence you may not distribute the Library at all. For example, if a patent license would not permit royalty free redistribution of the Library by all those who receive copies directly or indirectly through you, then the only way you could satisfy both it and this License would be to refrain entirely from distribution of the Library.

If any portion of this section is held invalid or unenforceable under any particular circumstance, the balance of the section is intended to apply, and the section as a whole is intended to apply in other circumstances.

It is not the purpose of this section to induce you to infringe any patents or other property right claims or to contest validity of any such claims; this section has the sole purpose of protecting the integrity of the free software distribution system which is implemented by public license practices. Many people have made generous contributions to the wide range of software distributed through that system in reliance on consistent application of that system; it is up to the author/donor to decide if he or she is willing to distribute software through any other system and a licensee cannot impose that choice.

This section is intended to make thoroughly clear what is believed to be a consequence of the rest of this License.

12. If the distribution and/or use of the Library is restricted in certain countries either by patents or by copyrighted interfaces, the original copyright holder who places the Library under this License may add an explicit geographical distribution limitation excluding those countries, so that distribution is permitted only in or among countries not thus excluded. In such case, this License incorporates the limitation as if written in the body of this License.

13. The Free Software Foundation may publish revised and/or new versions of the Lesser General Public License from time to time. Such new versions will be similar in spirit to the present version, but may differ in detail to address new problems or concerns.

Each version is given a distinguishing version number. If the Library specifies a version number of this License which applies to it and “any later version”, you have the option of following the terms and conditions either of that version or of any later version published by the Free Software Foundation. If the Library does not specify a license version number, you may choose any version ever published by the Free Software Foundation.

14. If you wish to incorporate parts of the Library into other free programs whose distribution conditions are incompatible with these, write to the author to ask for permission. For software which is copyrighted by the Free Software Foundation, write to the Free Software Foundation; we sometimes make exceptions for this. Our decision will be guided by the two goals of preserving the free status of all derivatives of our free software and of promoting the sharing and reuse of software generally.

NO WARRANTY

15. BECAUSE THE LIBRARY IS LICENSED FREE OF CHARGE, THERE IS NO WARRANTY FOR THE LIBRARY, TO THE EXTENT PERMITTED BY APPLICABLE LAW. EXCEPT WHEN OTHERWISE STATED IN WRITING THE COPYRIGHT HOLDERS AND/OR OTHER PARTIES PROVIDE THE LIBRARY “AS IS” WITHOUT WARRANTY OF ANY KIND, EITHER EXPRESSED OR IMPLIED, INCLUDING, BUT NOT LIMITED TO, THE IMPLIED WARRANTIES OF MERCHANTABILITY AND FITNESS FOR A PARTICULAR PURPOSE. THE ENTIRE RISK AS TO THE QUALITY AND PERFORMANCE OF THE LIBRARY IS WITH YOU. SHOULD THE LIBRARY PROVE DEFECTIVE, YOU ASSUME THE COST OF ALL NECESSARY SERVICING, REPAIR OR CORRECTION.

16. IN NO EVENT UNLESS REQUIRED BY APPLICABLE LAW OR AGREED TO IN WRITING WILL ANY COPYRIGHT HOLDER, OR ANY OTHER PARTY WHO MAY MODIFY AND/OR REDISTRIBUTE THE LIBRARY AS PERMITTED ABOVE, BE LIABLE TO YOU FOR DAMAGES, INCLUDING ANY GENERAL, SPECIAL, INCIDENTAL OR CONSEQUENTIAL DAMAGES ARISING OUT OF THE USE OR INABILITY TO USE THE LIBRARY (INCLUDING BUT NOT LIMITED TO LOSS OF DATA OR

DATA BEING RENDERED INACCURATE OR LOSSES SUSTAINED BY YOU OR THIRD PARTIES OR A FAILURE OF THE LIBRARY TO OPERATE WITH ANY OTHER SOFTWARE), EVEN IF SUCH HOLDER OR OTHER PARTY HAS BEEN ADVISED OF THE POSSIBILITY OF SUCH DAMAGES.

END OF TERMS AND CONDITIONS

How to Apply These Terms to Your New Libraries

If you develop a new library, and you want it to be of the greatest possible use to the public, we recommend making it free software that everyone can redistribute and change. You can do so by permitting redistribution under these terms (or, alternatively, under the terms of the ordinary General Public License).

To apply these terms, attach the following notices to the library. It is safest to attach them to the start of each source file to most effectively convey the exclusion of warranty; and each file should have at least the “copyright” line and a pointer to where the full notice is found. one line to give the library’s name and an idea of what it does.

Copyright (C) year name of author

This library is free software; you can redistribute it and/ or modify it under the terms of the GNU Lesser General Public License as published by the Free Software Foundation; either version 2.1 of the License, or (at your option) any later version.

This library is distributed in the hope that it will be useful, but WITHOUT ANY WARRANTY; without even the implied warranty of MERCHANTABILITY or FITNESS FOR A PARTICULAR PURPOSE. See the GNU Lesser General Public License for more details.

You should have received a copy of the GNU Lesser General Public License along with this library; if not, write to the Free Software

Foundation, Inc., 51 Franklin Street, Fifth Floor, Boston, MA 02110-1301 USA Also add information on how to contact you by electronic and paper mail.

You should also get your employer (if you work as a programmer) or your school, if any, to sign a “copyright disclaimer” for the library, if necessary. Here is a sample; alter the names:

Yoyodyne, Inc., hereby disclaims all copyright interest in the library ‘Frob’ (a library for tweaking knobs) written by James Random Hacker.

signature of Ty Coon, 1 April 1990 Ty Coon,
President of Vice.



SALES NETWORK

SAMSUNG TECHWIN CO., LTD.

Samsungtechwin R&D Center, 701, Sampyeong-dong, Bundang-gu, Seongnam-si, Gyeonggi-do, Korea, 463-400
TEL : +82-70-7147-8740~60 FAX : +82-31-8018-3745

SAMSUNG TECHWIN AMERICA Inc.

1480 Charles Willard St, Carson, CA 90746, UNITED STATES
Tol Free : +1-877-213-1222 FAX : +1-310-632-2195
www.samsungcctvusa.com

SAMSUNG TECHWIN EUROPE LTD.

Samsung House, 1000 Hillswood Drive, Hillswood Business
Park Chertsey, Surrey, UNITED KINGDOM KT16 0PS
TEL : +44-1932-45-5300 FAX : +44-1932-45-5325

www.samsungtechwin.com
www.samsungsecurity.com

Z6809131701A