

Network Video Recorder

User Manual

UD.6L0202D1509A02

Regulatory information

FCC information

FCC compliance: This equipment has been tested and found to comply with the limits for a digital device, pursuant to part 15 of the FCC Rules. These limits are designed to provide reasonable protection against harmful interference when the equipment is operated in a commercial environment. This equipment generates, uses, and can radiate radio frequency energy and, if not installed and used in accordance with the instruction manual, may cause harmful interference to radio communications. Operation of this equipment in a residential area is likely to cause harmful interference in which case the user will be required to correct the interference at his own expense.

FCC conditions

This device complies with part 15 of the FCC Rules. Operation is subject to the following two conditions:

1. This device may not cause harmful interference.
2. This device must accept any interference received, including interference that may cause undesired operation.

EU Conformity Statement



This product and - if applicable - the supplied accessories too are marked with "CE" and comply therefore with the applicable harmonized European standards listed under the Low Voltage Directive 2006/95/EC, the EMC Directive 2004/108/EC, the RoHS Directive 2011/65/EU.



2012/19/EU (WEEE directive): Products marked with this symbol cannot be disposed of as unsorted municipal waste in the European Union. For proper recycling, return this product to your local supplier upon the purchase of equivalent new equipment, or dispose of it at designated collection points. For more information see: www.recyclethis.info.



2006/66/EC (battery directive): This product contains a battery that cannot be disposed of as unsorted municipal waste in the European Union. See the product documentation for specific battery information. The battery is marked with this symbol, which may include lettering to indicate cadmium (Cd), lead (Pb), or mercury (Hg). For proper recycling, return the battery to your supplier or to a designated collection point. For more information see: www.recyclethis.info.

Preventive and Cautionary Tips

Before connecting and operating your device, please be advised of the following tips:

- Ensure unit is installed in a well-ventilated, dust-free environment.
- Unit is designed for indoor use only.
- Keep all liquids away from the device.
- Ensure environmental conditions meet factory specifications.
- Ensure unit is properly secured to a rack or shelf. Major shocks or jolts to the unit as a result of dropping it may cause damage to the sensitive electronics within the unit.
- Use the device in conjunction with an UPS if possible.
- Power down the unit before connecting and disconnecting accessories and peripherals.
- A factory recommended HDD should be used for this device.
- Improper use or replacement of the battery may result in hazard of explosion. Replace with the same or equivalent type only. Dispose of used batteries according to the instructions provided by the battery manufacturer.

Trademarks and Registered Trademarks

- Windows and Windows mark are trademarks or registered trademarks of Microsoft Corporation in the United States and/or other countries.
- HDMI, HDMI mark and High-Definition Multimedia Interface are trademarks or registered trademarks of HDMI Licensing LLC.
- The products contained in this manual are authorized by HDMI Licensing LLC with the use right of the HDMI technology.



- VGA is the trademark of IBM.
- UPnP™ is a certification mark of the UPnP™ Implementers Corporation.
- Other names of companies and product contained in this manual may be trademarks or registered trademarks of their respective owners.

Thank you for purchasing our product. If there is any question or request, please do not hesitate to contact dealer. The figures in the manual are for reference only.

This manual is applicable to the models listed in the following table.

Series	Model	Type
9600NI-ST	DS-9608NI-ST DS-9616NI-ST DS-9632NI-ST DS-9664NI-ST	Network Video Recorder
9600NI-RT	DS-9608NI-RT DS-9616NI-RT DS-9632NI-RT DS-9664NI-RT	Network Video Recorder
9600NI-XT	DS-9616NI-XT DS-9632NI-XT DS-9664NI-XT	Network Video Recorder
8600NI-ST	DS-8608NI-ST DS-8616NI-ST DS-8632NI-ST DS-8664NI-ST	Network Video Recorder
7700NI-ST	DS-7708NI-ST DS-7716NI-ST DS-7732NI-ST DS-7764NI-ST	Network Video Recorder
7700NI-SP	DS-7708NI-SP DS-7716NI-SP DS-7732NI-SP	Network Video Recorder
7600NI-ST	DS-7608NI-ST DS-7616NI-ST DS-7632NI-ST	Network Video Recorder
7600NI-SP	DS-7608NI-SP DS-7616NI-SP DS-7632NI-SP	Network Video Recorder

Product Key Features

General

- Connectable to network cameras, network dome and encoders.
- Connectable to the third-party network cameras like ACTI, Arecont, AXIS, Bosch, Brickcom, Canon, PANASONIC, Pelco, SAMSUNG, SANYO, SONY, Vivotek and ZAVIO, and cameras that adopt ONVIF or PSIA protocol.
- Connectable to the smart IP cameras.
- PAL/NTSC adaptive video inputs.
- Each channel supports dual-stream.
- Up to 64 network cameras can be connected for DS-9600NI-ST&RT&XT, DS-8600NI-ST and DS-7700NI-ST series NVR, and 32 network cameras for DS-7600NI-ST&SP and DS-7700NI-SP series.
- Independent configuration for each channel, including resolution, frame rate, bit rate, image quality, etc.
- The quality of the input and output record is configurable.

Local Monitoring

- Simultaneous HDMI, VGA and CVBS outputs.
- HDMI output and VGA output at up to 1920×1080 resolution.
- Multiple screen display in live view is supported, and the display sequence of channels is adjustable.
- Live view screen can be switched in group. Manual switch and auto-switch are provided and the auto-switch interval is configurable.
- Quick setting menu is provided for live view.
- Motion detection, video tampering, video exception alert and video loss alert functions.
- Privacy mask.
- Multiple PTZ protocols supported; PTZ preset, patrol and pattern.
- Zooming in by clicking the mouse and PTZ tracing by dragging mouse.

HDD Management

- For 9600NI-XT series, up to 16 SATA hard disks and 2 eSATA disks can be connected. For 7600NI-ST/SP series, 2 SATA hard disks and 1 eSATA disks can be connected. For 7700NI-ST/SP series, 4 SATA hard disks and 1 eSATA disk can be connected. And up to 8 SATA hard disks and 1 eSATA disk can be connected for other models. (Each disk with a maximum of 4TB storage capacity.)
- 8 network disks (8 NAS disks, or 7 NAS disks+1 IP SAN disk) can be connected.
- Support eSATA disks for recording or backup.
- Support S.M.A.R.T. and bad sector detection. (Not supported with DS-9600NI-RT series NVR.)
- HDD group management.
- Support HDD standby function.
- HDD property: redundancy, read-only, read/write (R/W).
- HDD quota management; different capacity can be assigned to different channel.
- Hot-swappable HDD supporting RAID0, RAID1, RAID5 and RAID10 storage scheme. And 8 virtual disks can be configured. (Only for the DS-9600NI-RT series NVR.)
- Hot-swappable HDD supporting RAID0, RAID1, RAID5 and RAID10 storage scheme, and can be enabled and disabled on your demand. And 16 arrays can be configured. (Only for the DS-9600NI-ST&XT and DS-8600NI-ST series NVR.)
- Support disk clone to the eSATA disk.

Recording, Capture and Playback

- Holiday recording schedule configuration.
- Continuous and event video recording parameters.
- Multiple recording types: manual, continuous, alarm, motion, motion | alarm, motion & alarm.
- 8 recording time periods with separated recording types.
- Pre-record and post-record for alarm, motion detection for recording, and pre-record time for schedule and manual recording.
- Searching record files and captured pictures by events (alarm input/motion detection).
- Tag adding for record files, searching and playing back by tags.
- Locking and unlocking record files.
- Local redundant recording and capture.
- Provide new playback interface with easy and flexible operation.
- Searching and playing back record files by channel number, recording type, start time, end time, etc.
- Smart search for the selected area in the video.
- Zooming in when playback.
- Reverse playback of multi-channel.
- Supports pause, play reverse, speed up, speed down, skip forward, and skip backward when playback, and locating by dragging the mouse.
- Up to 16-ch synchronous playback at 4CIF real time.
- Manual capture, continuous capture of video images and playback of captured pictures.

Backup

- Export video data by USB, SATA or eSATA device.
- Export video clips when playback.
- Management and maintenance of backup devices.
- Either Normal or Hot Spare working mode is configurable to constitute an N+1 hot spare system.

Alarm and Exception

- Configurable arming time of alarm input/output.
- Alarm for video loss, motion detection, tampering, abnormal signal, video input/output standard mismatch, illegal login, network disconnected, IP confliction, abnormal record/capture, HDD error, and HDD full, etc.
- Alarm triggers full screen monitoring, audio alarm, notifying surveillance center, sending email and alarm output.
- Automatic restore when system is abnormal.

Other Local Functions

- Operable by front panel, mouse, remote control, and control keyboard.
- Three-level user management; admin user is allowed to create many operating accounts and define their operating permission, which includes the limit to access any channel.
- Operation, alarm, exceptions and log recording and searching.
- Manually triggering and clearing alarms.
- Import and export of device configuration information.

Network Functions

- 2 self-adaptive 10M/100M/1000M network interfaces, and various working modes are configurable: multi-address, load balance, network fault tolerance, etc. (Two NIC are only for the DS-9600NI-ST/RT/XT and DS-8600NI-ST series NVR.)
- 8 independent PoE network interfaces are provided for DS-7600NI-SP series and up to 16 independent PoE network interfaces are provided for DS-7700NI-SP series.

- IPv6 is supported.
- TCP/IP protocol, PPPoE, DHCP, DNS, DDNS, NTP, SADP, SMTP, SNMP, NFS, and iSCSI are supported.
- TCP, UDP and RTP for unicast.
- Auto/Manual port mapping by UPnP™.
- Remote web browser access by HTTPS ensures high security.
- Remote reverse playback via RTSP.
- Support accessing by the platform via ONVIF.
- Remote search, playback, download, locking and unlocking of the record files, and support downloading files broken transfer resume.
- Remote parameters setup; remote import/export of device parameters.
- Remote viewing of the device status, system logs and alarm status.
- Remote keyboard operation.
- Remote locking and unlocking of control panel and mouse.
- Remote HDD formatting and program upgrading.
- Remote system restart and shutdown.
- RS-232, RS-485 transparent channel transmission.
- Alarm and exception information can be sent to the remote host
- Remotely start/stop recording.
- Remotely start/stop alarm output.
- Remote PTZ control.
- Remote JPEG capture.
- Virtual host function is provided to get access and manage the IP camera directly.
- Two-way audio and voice broadcasting.
- Embedded WEB server.

Development Scalability:

- SDK for Windows and Linux system.
- Source code of application software for demo.
- Development support and training for application system.

TABLE OF CONTENTS

Product Key Features	5
Chapter 1 Introduction	12
1.1 Front Panel	13
1.2 IR Remote Control Operations	20
1.3 USB Mouse Operation	22
1.4 Input Method Description.....	23
1.5 Rear Panel	24
Chapter 2 Getting Started	27
2.1 Starting Up and Shutting Down the NVR.....	28
2.2 Using the Wizard for Basic Configuration.....	30
2.3 Adding and Connecting the IP Cameras	35
2.3.1 Adding the Online IP Cameras.....	35
2.3.2 Editing the Connected IP Cameras and Configuring Customized Protocols	38
2.3.3 Editing IP Cameras Connected to the PoE Interfaces	40
Chapter 3 Live View	43
3.1 Introduction of Live View	44
3.2 Operations in Live View Mode.....	45
3.2.1 Front Panel Operation on Live View.....	45
3.2.2 Using the Mouse in Live View.....	46
3.2.3 Using an Auxiliary Monitor	47
3.2.4 Quick Setting Toolbar in Live View Mode	47
3.3 Adjusting Live View Settings	50
3.4 Channel-zero Encoding	52
3.5 User Logout.....	53
Chapter 4 PTZ Controls	54
4.1 Configuring PTZ Settings.....	55
4.2 Setting PTZ Presets, Patrols & Patterns.....	57
4.2.1 Customizing Presets.....	57
4.2.2 Calling Presets	57
4.2.3 Customizing Patrols.....	58
4.2.4 Calling Patrols	59
4.2.5 Customizing Patterns	60
4.2.6 Calling Patterns.....	60
4.2.7 Customizing Linear Scan Limit	61
4.2.8 Calling Linear Scan	62
4.2.9 One-touch Park	62
4.3 PTZ Control Panel.....	64
Chapter 5 Recording and Capture Settings	65
5.1 Configuring Parameters.....	66
5.2 Configuring Recording/Capture Schedule.....	69
5.3 Configuring Motion Detection Recording and Capture.....	73
5.4 Configuring Alarm Triggered Recording and Capture.....	75

5.5	Manual Recording and Continuous Capture.....	77
5.6	Configuring Holiday Recording and Capture.....	79
5.7	Configuring Redundant Recording and Capture.....	81
5.8	Configuring HDD Group for Recording and Capture.....	83
5.9	Files Protection.....	84
5.9.1	Locking the Recording Files.....	84
5.9.2	Setting HDD Property to Read-only.....	86
Chapter 6	Playback.....	88
6.1	Playing Back Record Files.....	89
6.1.1	Playing Back by Channel.....	89
6.1.2	Playing Back by Time.....	91
6.1.3	Playing Back by Event Search.....	93
6.1.4	Playing Back by Tag.....	95
6.1.5	Smart Playback.....	98
6.1.6	Playing Back by System Logs.....	100
6.1.7	Playing Back External File.....	102
6.2	Auxiliary Functions of Playback.....	103
6.2.1	Playing Back Frame by Frame.....	103
6.2.2	Digital Zoom.....	103
6.2.3	Reverse Playback of Multi-channel.....	104
6.3	Picture Playback.....	105
Chapter 7	Backup.....	107
7.1	Backing up Record Files.....	108
7.1.1	Quick Export.....	108
7.1.2	Backing up by Normal Video Search.....	109
7.1.3	Backing up by Event Search.....	116
7.1.4	Backing up Video Clips.....	118
7.2	Backing up Pictures.....	121
7.3	Managing Backup Devices.....	123
7.4	Hot Spare Device Backup.....	126
7.4.1	Setting Hot Spare Device.....	126
7.4.2	Setting Working Device.....	127
7.4.3	Managing Hot Spare System.....	127
Chapter 8	Alarm Settings.....	130
8.1	Setting Motion Detection Alarm.....	131
8.2	Setting Sensor Alarms.....	133
8.3	Detecting Video Loss Alarm.....	136
8.4	Detecting Video Tampering Alarm.....	138
8.5	Detecting VCA Alarm.....	140
8.6	Handling Exceptions Alarm.....	142
8.7	Setting Alarm Response Actions.....	143
8.8	Triggering or Clearing Alarm Output Manually.....	146
Chapter 9	Network Settings.....	147
9.1	Configuring General Settings.....	148

9.2	Configuring Advanced Settings	150
9.2.1	Configuring PPPoE Settings	150
9.2.2	Configuring DDNS	150
9.2.3	Configuring NTP Server	154
9.2.4	Configuring SNMP	154
9.2.5	Configuring Remote Alarm Host	155
9.2.6	Configuring Multicast	156
9.2.7	Configuring RTSP	156
9.2.8	Configuring Server and HTTP Ports	156
9.2.9	Configuring HTTPS Port	157
9.2.10	Configuring Email	159
9.2.11	Configuring NAT	160
9.2.12	Configuring High-speed Download	163
9.2.13	Configuring Virtual Host	164
9.2.14	Configuring Telnet	165
9.3	Checking Network Traffic	166
9.4	Configuring Network Detection	167
9.4.1	Testing Network Delay and Packet Loss	167
9.4.2	Exporting Network Packet	167
9.4.3	Checking the Network Status	168
9.4.4	Checking Network Statistics	169
Chapter 10	RAID (Only for DS-9600NI-RT series NVR)	171
10.1	Configuring Array and Virtual Disk	172
10.1.1	One-touch Configuration	173
10.1.2	Manually Creating Array and Virtual Disk	174
10.2	Rebuilding Array	179
10.2.1	Automatically Rebuilding Array	179
10.2.2	Manually Rebuilding Array	180
10.3	Repairing Virtual Disk	182
10.4	Deleting Array / Virtual Disk	183
10.4.1	Deleting the Virtual Disk	183
10.4.2	Deleting the Array	183
10.5	Upgrading Firmware	185
Chapter 11	RAID (Only for DS-9600NI-ST&XT and DS-8600NI-ST series NVR)	187
11.1	Configuring Array	188
11.1.1	Enable RAID	188
11.1.2	One-touch Configuration	189
11.1.3	Manually Creating Array	190
11.2	Rebuilding Array	193
11.2.1	Automatically Rebuilding Array	193
11.2.2	Manually Rebuilding Array	194
11.3	Deleting Array	196
11.4	Checking and Editing Firmware	197
Chapter 12	HDD Management	198

12.1	Initializing HDDs	199
12.2	Managing Network HDD	201
12.3	Managing eSATA	203
12.4	Managing HDD Group	204
12.4.1	Setting HDD Groups.....	204
12.4.2	Setting HDD Property	205
12.5	Configuring Quota Mode.....	207
12.6	Configuring Disk Clone	209
12.7	Checking HDD Status	211
12.8	HDD Detection.....	213
12.9	Configuring HDD Error Alarms	215
Chapter 13	Camera Settings	216
13.1	Configuring OSD Settings.....	217
13.2	Configuring Privacy Mask.....	218
13.3	Configuring Video Parameters	219
Chapter 14	NVR Management and Maintenance	220
14.1	Viewing System Information.....	221
14.1.1	Viewing Device Information.....	221
14.1.2	Viewing Camera Information.....	221
14.1.3	Viewing Record Information	221
14.1.4	Viewing Alarm Information	222
14.1.5	Viewing Network Information	222
14.1.6	Viewing HDD Information	223
14.2	Searching & Export Log Files	224
14.3	Importing/Exporting IP Camera Info.....	227
14.4	Importing/Exporting Configuration Files	228
14.5	Upgrading System	229
14.5.1	Upgrading by Local Backup Device	229
14.5.2	Upgrading by FTP	229
14.6	Restoring Default Settings.....	231
Chapter 15	Others.....	232
15.1	Configuring RS-232 Serial Port.....	233
15.2	Configuring General Settings	234
15.3	Configuring DST Settings	235
15.4	Configuring More Settings for Device Parameters.....	236
15.5	Managing User Accounts.....	237
15.5.1	Adding a User	237
15.5.2	Deleting a User	239
15.5.3	Editing a User	239
Appendix	241
Glossary		242
Troubleshooting		243
Summary of Changes		249
List of Compatible IP Cameras		250

Chapter 1 Introduction

1.1 Front Panel

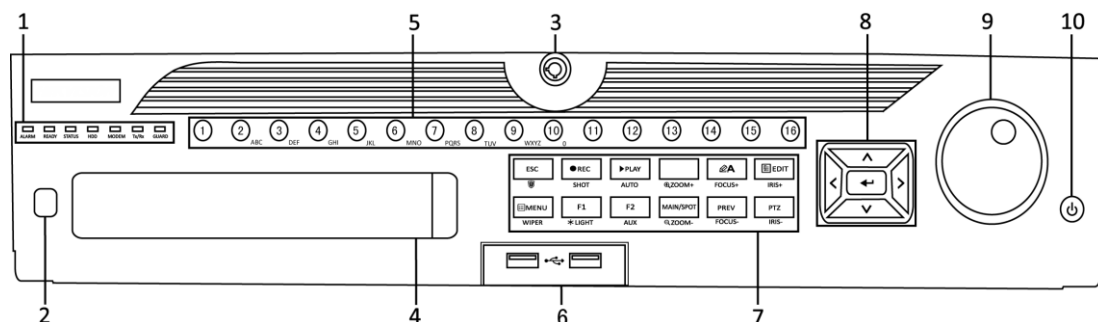

Figure 1. 1 DS-9600NI-ST/RT

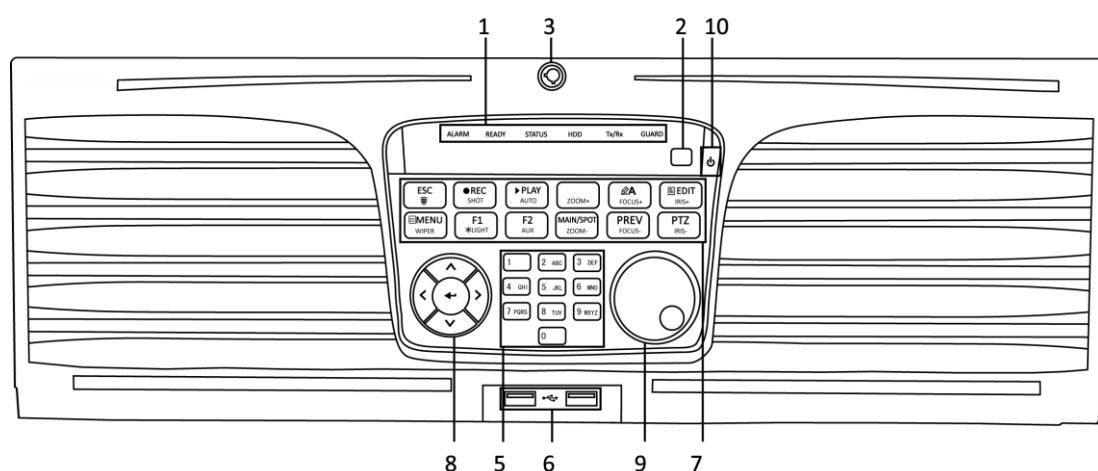

Figure 1. 2 DS-9600NI-XT

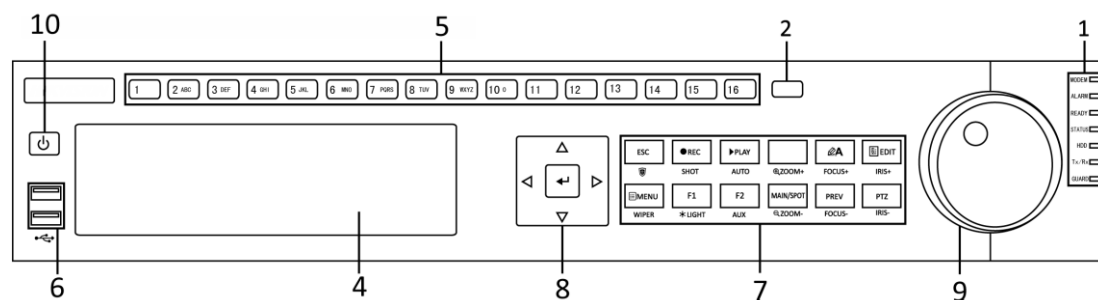

Figure 1. 3 DS-8600NI-ST

Table 1. 1 Description of Control Panel Buttons

No.	Name	Function Description
1	ALARM	Turns red when a sensor alarm is detected.
	READY	Ready indicator is normally blue, indicating that the device is functioning properly.
	STATUS	Turns blue when device is controlled by an IR remote.

No.	Name	Function Description	
		Turns red when controlled by a keyboard and purple when IR remote and keyboard is used at the same time.	
		HDD	Blinks red when data is being read from or written to HDD.
		MODEM (Not for DS-9600NI-XT)	Reserved for future usage.
		TX/RX	Blinks blue when network connection is functioning properly.
		GUARD	Guard indicator turns blue when the device is in armed status; at this time, an alarm is enabled when an event is detected.
The indicator turns off when the device is unarmed. The arm/disarm status can be changed by pressing and holding on the ESC button for more than 3 seconds in live view mode.			
2	IR Receiver	Receiver for IR remote	
3	Front Panel Lock (for DS-9600NI-ST/RT/XT series)	You can lock or unlock the panel by the key.	
4	DVD-R/W	Slot for DVD-R/W.	
5	Alphanumeric Buttons	Switch to the corresponding channel in Live view or PTZ Control mode.	
		Input numbers and characters in Edit mode.	
		Switch between different channels in Playback mode.	
		The light of the button is blue when the corresponding channel is recording; it is red when the channel is in network transmission status; it is pink when the channel is recording and transmitting.	
6	USB Interfaces	Universal Serial Bus (USB) ports for additional devices such as USB mouse and USB Hard Disk Drive (HDD).	
7	Composite Keys	ESC	Back to the previous menu.
			Press the button for 3 seconds to arm/disarm the pre-configured linkage actions for events when you in the Live View mode.
		REC/SHOT	Enter the Manual Record setting menu.
			In PTZ control settings, press the button and then you can call a PTZ preset by pressing Numeric button.
			It is also used to turn audio on/off in the Playback mode.
		PLAY/AUTO	The button is used to enter the Playback mode.
			It is also used to auto scan in the PTZ Control menu.
		ZOOM+	Zoom in the PTZ camera in the PTZ Control setting.
		A/FOCUS+	Adjust focus in the PTZ Control menu.
			It is also used to switch between input methods (upper and lowercase alphabet, symbols and numeric input).
		EDIT/IRIS+	Edit text fields. When editing text fields, it will also function as a Backspace button to delete the character in front of the cursor.
			On checkbox fields, pressing the button will <i>tick</i> the checkbox.
			In PTZ Control mode, the button adjusts the iris of the camera.
			In Playback mode, it can be used to generate video clips for backup.
			Enter/exit the folder of USB device and eSATA HDD.

No.	Name	Function Description	
		MAIN/SPOT/ZOO	Switch between main and spot output.
		M-	In PTZ Control mode, it can be used to zoom out the image.
		F1/ LIGHT	Select all items on the list when used in a list field.
			In PTZ Control mode, it will turn on/off PTZ light (if applicable).
			In Playback mode, it is used to switch between play and reverse play.
		F2/AUX	Cycle through tab pages.
			In synchronous playback mode, it is used to switch between channels.
		MENU/WIPER	Press the button will help you return to the Main menu (after successful login).
			Press and hold the button for 5 seconds will turn off audible key beep.
			In PTZ Control mode, the MENU/WIPER button will start wiper (if applicable).
			In Playback mode, it is used to show/hide the control interface.
		PREV/FOCUS-	Switch between single screen and multi-screen mode.
			In PTZ Control mode, it is used to adjust the focus in conjunction with the A/FOCUS+ button.
		PTZ/IRIS-	Enter the PTZ Control mode.
In the PTZ Control mode, it is used to adjust the iris of the PTZ camera.			
8	Control Buttons	DIRECTION	The DIRECTION buttons are used to navigate between different fields and items in menus.
			In the Playback mode, the Up and Down button is used to speed up and slow down recorded video. The Left and Right button will select the next and previous record files.
			In Live View mode, these buttons can be used to cycle through channels.
			In PTZ control mode, it can control the movement of the PTZ camera.
	ENTER	The ENTER button is used to confirm selection in any of the menu modes.	
		It can also be used to <i>tick</i> checkbox fields.	
		In Playback mode, it can be used to play or pause the video.	
		In single-frame Playback mode, pressing the button will advance the video by a single frame.	
		In Auto-switch mode, it can be used to stop /start auto switch.	
9	JOG SHUTTLE Control	Move the active selection in a menu. It will move the selection up and down.	
		In Live View mode, it can be used to cycle through different channels.	
		In the Playback mode: For DS-9600NI-ST/RT/XT series, the ring is used to jump 30s forward/backward in video files. For DS-8600NI-ST series, the outer ring is used to speed up or slow	

No.	Name	Function Description
		down the record files and the inner ring is used to jump 30s forward/backward in records files.
		In PTZ control mode, it can control the movement of the PTZ camera.
10	POWER ON/OFF	Power on/off switch.

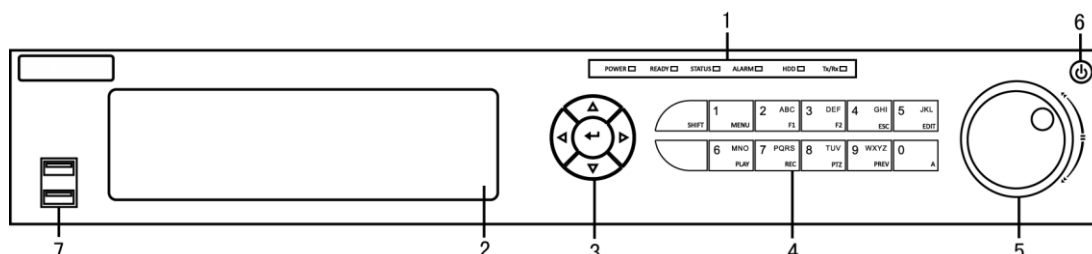

Figure 1. 4 DS-7700NI-ST/SP

Table 1. 2 Description of Control Panel Buttons

No.	Name	Function Description	
1	Status Indicators	POWER	Turns green when NVR is powered up.
		READY	The indicator is green when the device is running normally.
		STATUS	The light is green when the IR remote control is enabled; The light is red when the function of the composite keys (SHIFT) are used; The light is out when none of the above condition is met.
		ALARM	The light is red when there is an alarm occurring.
		HDD	Blinks red when HDD is reading/writing.
		Tx/Rx	Blinks green when network connection is functioning normally.
2	DVD-R/W	Slot for DVD-R/W.	
3	Control Buttons	DIRECTION	In menu mode, the direction buttons are used to navigate between different fields and items and select setting parameters.
			In playback mode, the Up and Down buttons are used to speed up and slow down record playing, and the Left and Right buttons are used to move the recording 30s forwards or backwards.
			In the image setting interface, the up and down button can adjust the level bar of the image parameters.
			In live view mode, these buttons can be used to switch channels.
		ENTER	The Enter button is used to confirm selection in menu mode; or used to check checkbox fields and ON/OFF switch.
	In playback mode, it can be used to play or pause the video.		
	In single-frame play mode, pressing the Enter button will play the video by a single frame.		
	In auto sequence view mode, the buttons can be used to pause or resume auto sequence.		
4	Composite Keys	SHIFT	Switch between the numeric or letter input and functions of the composite keys. (Input letter or numbers when the light is out;

No.	Name	Function Description
		Realize functions when the light is red.)
	1/MENU	Enter numeral "1"; Access the main menu interface.
	2/ABC/F1	Enter numeral "2"; Enter letters "ABC"; The F1 button when used in a list field will select all items in the list. In PTZ Control mode, it will turn on/off PTZ light and when the image is zoomed in, the key is used to zoom out.
	3/DEF/F2	Enter numeral "3"; Enter letters "DEF"; The F2 button is used to change the tab pages. In PTZ control mode, it zooms in the image.
	4/GHI/ESC	Enter numeral "4"; Enter letters "GHI"; Exit and back to the previous menu.
	5/JKL/EDIT	Enter numeral "5"; Enter letters "JKL"; Delete characters before cursor; Check the checkbox and select the ON/OFF switch; Start/stop record clipping in playback.
	6/MNO/PLAY	Enter numeral "6"; Enter letters "MNO"; Playback, for direct access to playback interface.
	7/PQRS/REC	Enter numeral "7"; Enter letters "PQRS"; Open the manual record interface.
	8/TUV/PTZ	Enter numeral "8"; Enter letters "TUV"; Access PTZ control interface.
	9/WXYZ/PRE V	Enter numeral "9"; Enter letters "WXYZ"; Multi-channel display in live view.
	0/A	Enter numeral "0"; Shift the input methods in the editing text field. (Upper and lowercase, alphabet, symbols or numeric input). Double press the button to switch the main and auxiliary output.
5	JOG SHUTTLE Control	Move the active selection in a menu. It will move the selection up and down. In Live View mode, it can be used to cycle through different channels. In the Playback mode, it can be used to jump 30s forward/backward in video files. In PTZ control mode, it can control the movement of the PTZ camera.

No.	Name	Function Description
6	POWER ON/OFF	Power on/off switch.
7	USB Interfaces	Universal Serial Bus (USB) ports for additional devices such as USB mouse and USB Hard Disk Drive (HDD).

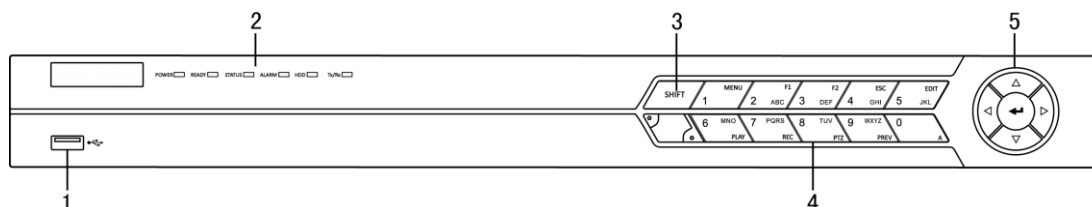

Figure 1. 5 DS-7600NI-ST/SP

Table 1. 3 Description of Control Panel Buttons

No.	Name	Function Description	
1	USB Interface	Connects USB mouse or USE flash memory devices.	
2	Status Indicators	POWER	Turns green when NVR is powered up.
		READY	The LED is green when the device is running normally.
		STATUS	The light is green when the IR remote control is enabled; The light is red when the function of the composite keys (SHIFT) are used; The light is out when none of the above condition is met.
		ALARM	The light is red when there is an alarm occurring.
		HDD	Blinks red when HDD is reading/writing.
		Tx/Rx	Blinks green when network connection is functioning normally.
3	SHIFT	Switch between the numeric or letter input and functions of the composite keys. (Input letter or numbers when the light is out; Realize functions when the light is red.)	
4	Composite Keys	SHIFT	Switch between the numeric or letter input and functions of the composite keys. (Input letter or numbers when the light is out; Realize functions when the light is red.)
		1/MENU	Enter numeral "1";
			Access the main menu interface.
		2/ABC/F1	Enter numeral "2";
			Enter letters "ABC";
			The F1 button when used in a list field will select all items in the list.
			In PTZ Control mode, it will turn on/off PTZ light and when the image is zoomed in, the key is used to zoom out.
		3/DEF/F2	Enter numeral "3";
			Enter letters "DEF";
			The F2 button is used to change the tab pages.
In PTZ control mode, it zooms in the image.			
4/GHI/ESC	Enter numeral "4";		

No.	Name	Function Description			
5	Control Buttons		Enter letters "GHI";		
			Exit and back to the previous menu.		
		5/JKL/EDIT	Enter numeral "5";		
			Enter letters "JKL";		
			Delete characters before cursor;		
			Check the checkbox and select the ON/OFF switch;		
			Start/stop record clipping in playback.		
		6/MNO/PLAY	Enter numeral "6";		
			Enter letters "MNO";		
			Playback, for direct access to playback interface.		
		7/PQRS/REC	Enter numeral "7";		
			Enter letters "PQRS";		
			Open the manual record interface.		
		8/TUV/PTZ	Enter numeral "8";		
			Enter letters "TUV";		
			Access PTZ control interface.		
		9/WXYZ/PRE V	Enter numeral "9";		
			Enter letters "WXYZ";		
			Multi-channel display in live view.		
		0/A	Enter numeral "0";		
			Shift the input methods in the editing text field. (Upper and lowercase, alphabet, symbols or numeric input).		
			Double press the button to switch the main and auxiliary output.		
		5	Control Buttons	DIRECTION	In menu mode, the direction buttons are used to navigate between different fields and items and select setting parameters.
					In playback mode, the Up and Down buttons are used to speed up and slow down record playing, and the Left and Right buttons are used to move the recording 30s forwards or backwards.
					In the image setting interface, the up and down button can adjust the level bar of the image parameters.
					In live view mode, these buttons can be used to switch channels.
				ENTER	The Enter button is used to confirm selection in menu mode; or used to check checkbox fields and ON/OFF switch.
In playback mode, it can be used to play or pause the video.					
In single-frame play mode, pressing the Enter button will play the video by a single frame.					
In auto sequence view mode, the buttons can be used to pause or resume auto sequence.					

1.2 IR Remote Control Operations

The NVR may also be controlled with the included IR remote control, shown in Figure 1. 6.



Batteries (2×AAA) must be installed before operation.

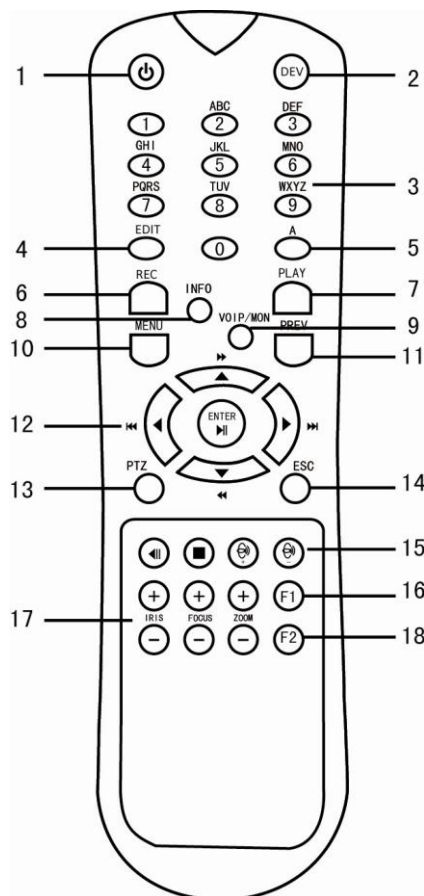

Figure 1. 6 Remote Control

The keys on the remote control closely resemble the ones on the front panel. See Table 1. 4.

Table 1. 4 Description of the Soft Keyboard Icons

No.	Name	Description
1	POWER	Power on/off the device.
2	DEV	Enables/Disables Remote Control.
3	Alphanumeric Buttons	Same as Alphanumeric buttons on front panel.
4	EDIT Button	Same as EDIT/IRIS+ button on front panel.
5	A Button	Same as A/FOCUS+ button on front panel.
6	REC Button	Same as REC/SHOT button on front panel.
7	PLAY Button	Same as the PLAY/AUTO button on front panel.
8	INFO Button	Reserved.
9	VOIP/MON Button	Same as the MAIN/SPOT/ZOOM- button on front panel.
10	MENU Button	Same as the MENU/WIPER button on front panel.

No.	Name	Description
11	PREV Button	Same as the PREV/FOCUS- button on front panel.
12	DIRECTION/ENTER Buttons	Same as the DIRECTION/ENTER buttons on front panel.
13	PTZ Button	Same as the PTZ/IRIS- button on front panel.
14	ESC Button	Same as the ESC button on front panel.
15	RESERVED	Reserved for future usage.
16	F1 Button	Same as the F1/LIGHT button on front panel.
17	PTZ Control Buttons	Buttons to adjust the iris, focus and zoom of a PTZ camera.
18	F2 Button	Same as the F2/AUX button on front panel.

Troubleshooting Remote Control:



Make sure you have installed batteries properly in the remote control. And you have to aim the remote control at the IR receiver in the front panel.

If there is no response after you press any button on the remote, follow the procedure below to troubleshoot.

Steps:

1. Go to Menu > Settings > General > More Settings by operating the front control panel or the mouse.
2. Check and remember NVR ID#. The default ID# is 255. This ID# is valid for all the IR remote controls.
3. Press the DEV button on the remote control.
4. Enter the NVR ID# you set in step 2.
5. Press the ENTER button on the remote.

If the Status indicator on the front panel turns blue, the remote control is operating properly. If the Status indicator does not turn blue and there is still no response from the remote, please check the following:

1. Batteries are installed correctly and the polarities of the batteries are not reversed.
2. Batteries are fresh and not out of charge.
3. IR receiver is not obstructed.

If the remote still can't function properly, please change a remote and try again, or contact the device provider.

1.3 USB Mouse Operation

A regular 3-button (Left/Right/Scroll-wheel) USB mouse can also be used with this NVR. To use a USB mouse:

1. Plug USB mouse into one of the USB interfaces on the front panel of the NVR.
2. The mouse should automatically be detected. If in a rare case that the mouse is not detected, the possible reason may be that the two devices are not compatible, please refer to the recommended the device list from your provider.

The operation of the mouse:

Table 1. 5 Description of the Mouse Control

Name	Action	Description
Left-Click	Single-Click	Live view: Select channel and show the quick set menu. Menu: Select and enter.
	Double-Click	Live view: Switch between single-screen and multi-screen.
	Click and Drag	PTZ control: pan, tilt and zoom. Video tampering, privacy mask and motion detection: Select target area. Digital zoom-in: Drag and select target area. Live view: Drag channel/time bar.
Right-Click	Single-Click	Live view: Show menu. Menu: Exit current menu to upper level menu.
Scroll-Wheel	Scrolling up	Live view: Previous screen. Menu: Previous item.
	Scrolling down	Live view: Next screen. Menu: Next item.

1.4 Input Method Description



Figure 1.7 Soft Keyboard (1)



Figure 1.8 Soft Keyboard (2)

Description of the buttons on the soft keyboard:

Table 1.6 Description of the Soft Keyboard Icons

Icon	Description	Icon	Description
	Number		English letter
	Lowercase/Uppercase		Backspace
	Switch the keyboard		Space
	Positioning the cursor		Exit
	Symbols		Reserved

1.5 Rear Panel

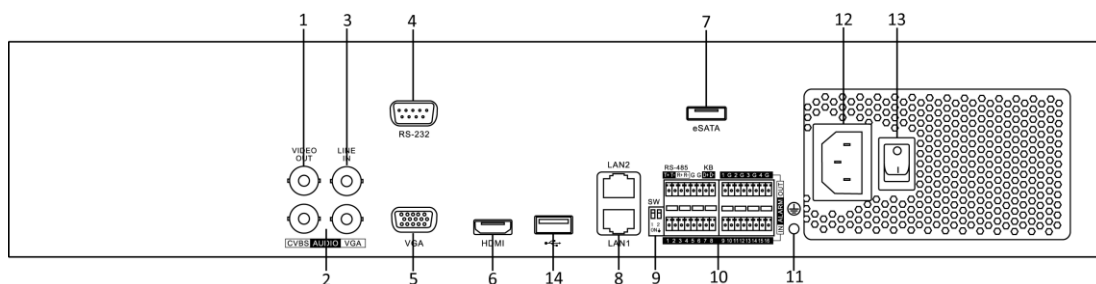

Figure 1.9 DS-9600NI-ST and DS-8600NI-ST

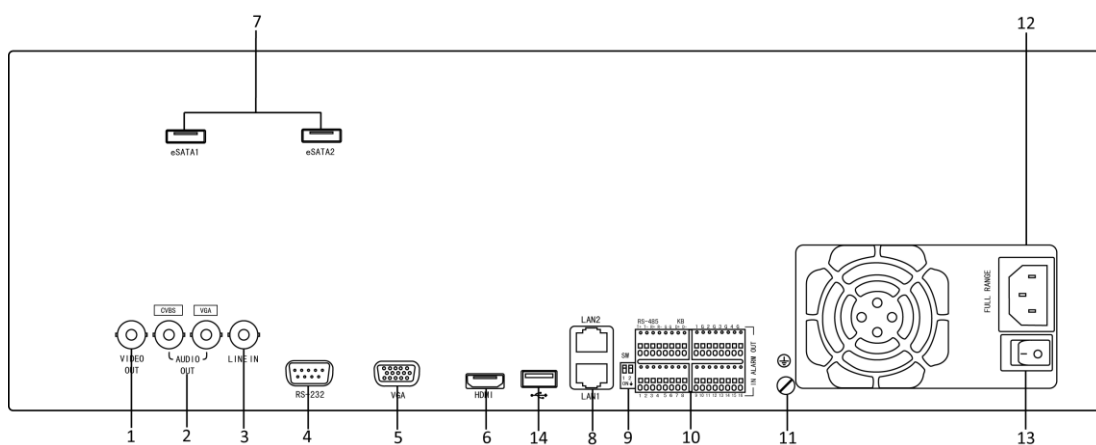

Figure 1.10 DS-9600NI-XT

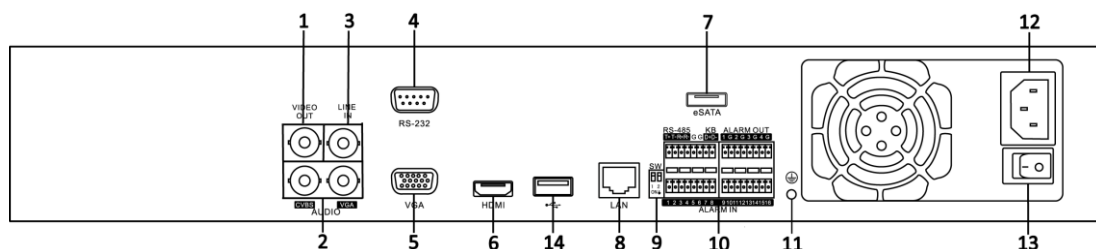

Figure 1.11 DS-7700NI-ST

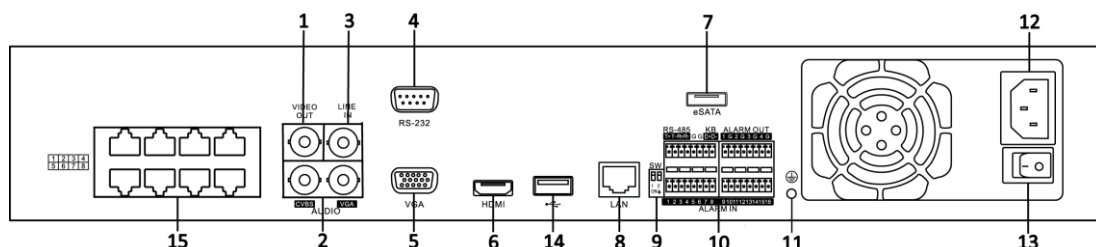

Figure 1.12 DS-7708NI-SP

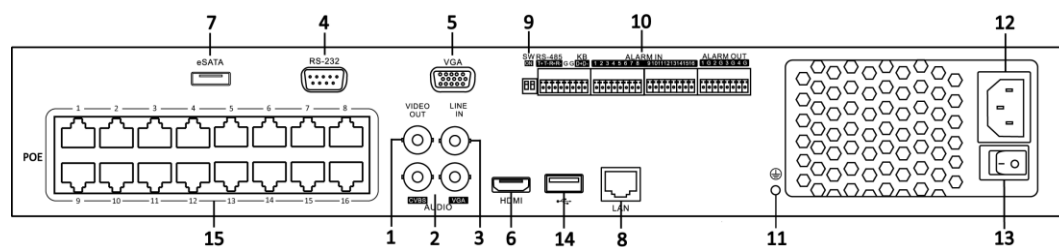

Figure 1. 13 DS-7716 / 7732NI-SP

Table 1. 7 Description of Rear Panel Interfaces

No.	Item	Description
1	VIDEO OUT	BNC connector for video output.
2	CVBS AUDIO OUT	BNC connector for audio output. This connector is synchronized with CVBS video output.
	VGA AUDIO OUT	BNC connector for audio output. This connector is synchronized with VGA video output.
3	LINE IN	BNC connector for audio input.
4	RS-232 Interface	Connector for RS-232 devices.
5	VGA	DB9 connector for VGA output. Display local video output and menu.
6	HDMI	HDMI video output connector.
7	eSATA (Optional)	Connects external SATA HDD, CD/DVD-RM. 2 eSATA interfaces for DS-9600NI-XT.
8	Network Interface	1 network interface provided for DS-7700NI-ST&SP and 2 network interfaces for DS-9600NI-ST/RT/XT and DS-8600NI-ST.
9	Termination Switch	RS-485 termination switch. Up position is not terminated. Down position is terminated with 120Ω resistance.
10	RS-485 Interface	Connector for RS-485 devices.
	Controller Port	D+, D- pin connects to Ta, Tb pin of controller. For cascading devices, the first NVR's D+, D- pin should be connected with the D+, D- pin of the next NVR.
	ALARM IN	Connector for alarm input.
	ALARM OUT	Connector for alarm output.
11	GROUND	Ground (needs to be connected when NVR starts up).
12	AC 100V ~ 240V	AC 100V ~ 240V power supply.
13	POWER	Switch for turning on/off the device.
14	USB interface	Universal Serial Bus (USB) ports for additional devices such as USB mouse and USB Hard Disk Drive (HDD).
15	Network Interfaces with PoE function (supported by DS-7700NI-SP only)	Network interface for the cameras and to provide power over Ethernet.

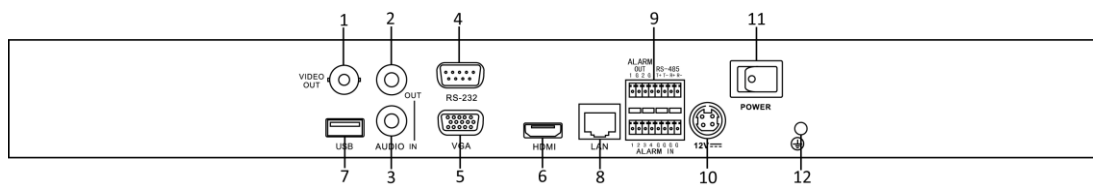

Figure 1. 14 DS-7600NI-ST

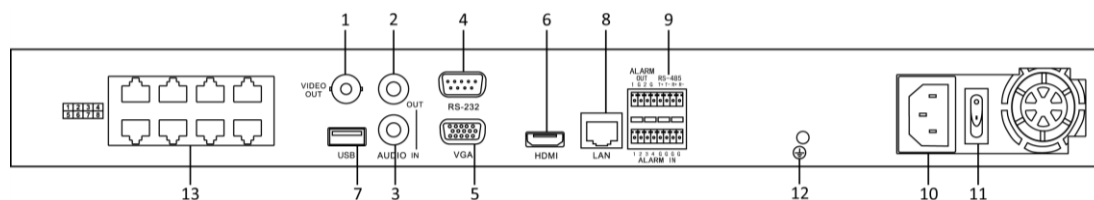

Figure 1. 15 DS-7600NI-SP

Table 1. 8 Description of Rear Panel Interfaces

No.	Item	Description
1	VIDEO OUT	BNC connector for video output.
2	AUDIO OUT	BNC connector for audio output.
3	AUDIO IN	BNC connector for audio input. (Also for voice talk)
4	RS-232 Interface	Connector for RS-232 devices.
5	VGA	DB9 connector for VGA output. Display local video output and menu.
6	HDMI	HDMI video output connector.
7	USB	Connects USB disks and devices.
8	Network Interface	Connector for LAN (Local Area Network).
9	RS-485 Interface	Connector for RS-485 devices.
	ALARM IN	Connector for alarm input.
	ALARM OUT	Connector for alarm output.
10	Power Supply	12VDC power supply for DS-7600NI-ST. 100~240VAC power supply for DS-7600NI-SP.
11	Power Switch	Switch for turning on/off the device.
12	Ground	Ground (needs to be connected when NVR starts up).
13	Network Interfaces with PoE function (supported by DS-7600NI-SP only)	Network interface for the cameras and to provide power over Ethernet.

Chapter 2 Getting Started

2.1 Starting Up and Shutting Down the NVR

Purpose:

Proper startup and shutdown procedures are crucial to expanding the life of the NVR.

Before you start:

Check that the voltage of the extra power supply is the same with the NVR's requirement, and the ground connection is working properly.

Starting up the NVR:

Steps:

1. Check the power supply is plugged into an electrical outlet. It is **HIGHLY** recommended that an Uninterruptible Power Supply (UPS) be used in conjunction with the device. The Power indicator LED on the front panel should be red, indicating the device gets the power supply.
2. Press the **POWER** button on the front panel. The Power indicator LED should turn blue indicating that the unit begins to start up.
3. After startup, the Power indicator LED remains blue. A splash screen with the status of the HDD appears on the monitor. The row of icons at the bottom of the screen shows the HDD status. 'X' means that the HDD is not installed or cannot be detected.

Shutting down the NVR

Steps:

There are two proper ways to shut down the NVR.

- **OPTION 1: Standard shutdown**

1. Enter the Shutdown menu.

Menu > Shutdown

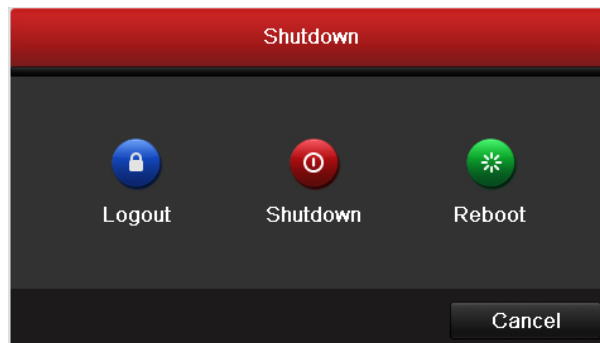

Figure 2. 1 Shutdown Menu

2. Click the **Shutdown** button.

3. Click the **Yes** button.

- **OPTION 2: By operating the front panel**

1. Press and hold the **POWER** button on the front panel for 3 seconds.
2. Enter the administrator's username and password in the dialog box for authentication.
3. Click the **Yes** button.



Do not press the **POWER** button again when the system is shutting down.

Rebooting the NVR

In the Shutdown menu, you can also reboot the NVR.

Steps:

1. Enter the **Shutdown** menu by clicking Menu > Shutdown.
2. Click the **Logout** button to lock the NVR or the **Reboot** button to reboot the NVR.

2.2 Using the Wizard for Basic Configuration

By default, the Setup Wizard starts once the NVR has loaded, as shown in Figure 2. 2.

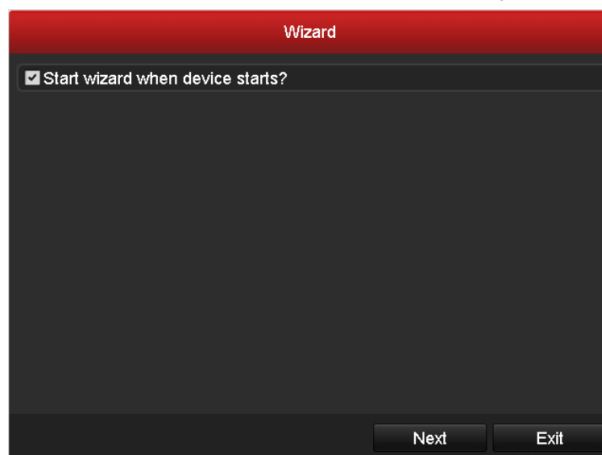

Figure 2. 2 Start Wizard Interface

Operating the Setup Wizard:

1. The Setup Wizard can walk you through some important settings of the NVR. If you don't want to use the Setup Wizard at that moment, click the **Cancel** button. You can also choose to use the Setup Wizard next time by leaving the "Start wizard when the device starts?" checkbox checked.
2. Click **Next** button on the Wizard window to enter the **Login** window, as shown in Figure 2. 3.

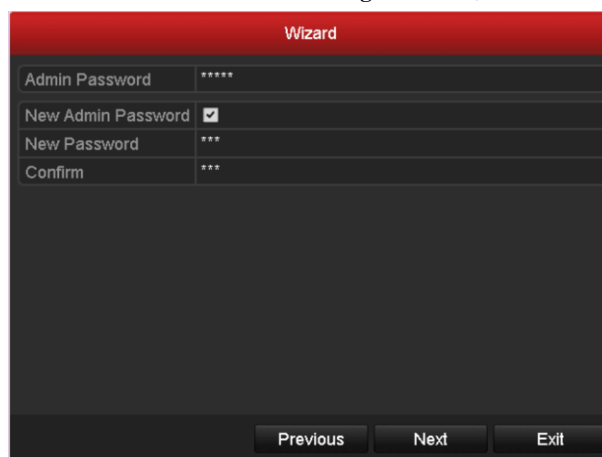

Figure 2. 3 Login Window

3. Enter the admin password. By default, the password is 12345.



You are highly recommended to change the initial password right after the first login to avoid safety problem.

4. To change the admin password, check the **New Admin Password** checkbox. Enter the new password and confirm the password in the given fields.
5. Click the **Next** button to enter the date and time settings window, as shown in Figure 2. 4.



Figure 2. 4 Date and Time Settings

6. After the time settings, click **Next** button which takes you back to the Network Setup Wizard window, as shown in Figure 2. 5.



DS-9600NI-ST/RT/XT and DS-8600NI-ST



DS-7700/7600NI-ST

Wizard	
NIC Type	10M/100M/1000M Self-adaptive
Enable DHCP	<input type="checkbox"/>
IPv4 Address	172 .9 .11 .212
IPv4 Subnet Mask	255 .255 .255 .0
IPv4 Default Gateway	172 .9 .11 .1
Preferred DNS Server	
Alternate DNS Server	
Internal NIC IPv4 Ad...	192 .168 .1 .1

Previous Next Exit

DS-7700/7600NI-SP

Figure 2. 5 Network Configuration



Dual-NIC is only supported in DS-9600NI-ST/RT/XT and DS-8600NI-ST device. And for DS-7700/7600NI-SP series NVR, the internal NIC IPv4 address should be configured for the cameras connecting to the PoE network interface of the NVR.

7. Click **Next** button after you configured the network parameters, which takes you to the RAID configuration window (supported by DS-9600NI-XT series only).

Wizard

Enable RAID

Previous Next Exit

Figure 2. 6 Array Management

8. Click **Next** button to enter the Array Management window (supported by DS-9600NI-RT series, and is also supported by DS-9600NI-XT if you check the checkbox to enable the RAID function in the previous window).

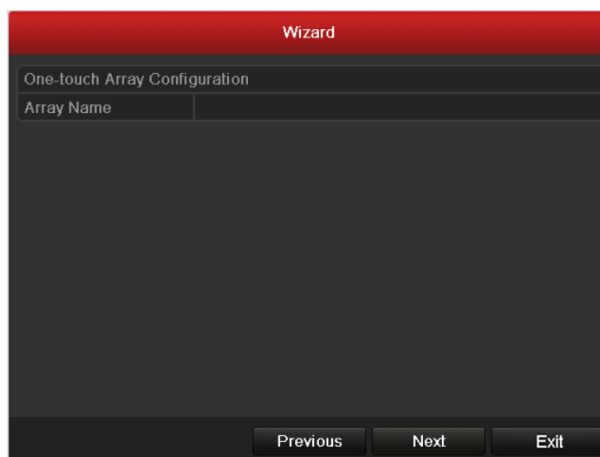

Figure 2. 7 Array Management

9. Click **Next** button after you configured the network parameters, which takes you to the **HDD Management** window, shown in Figure 2. 8.



Figure 2. 8 HDD Management

10. To initialize the HDD, click the **Init** button. Initialization removes all the data saved in the HDD.
11. Click **Next** button. You enter the **Adding IP Camera** interface.
12. Click **Search** to find online IP Camera. Select the IP camera to be added, and click the **Add** button.

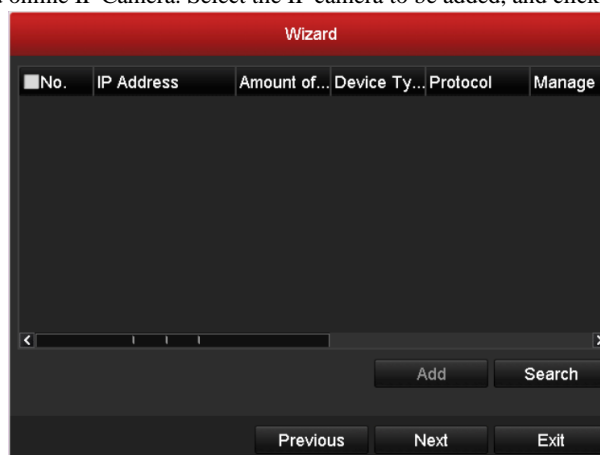

Figure 2. 9 Search for IP Cameras

13. Click **Next** button. Configure the recording for the searched IP Cameras.



Figure 2. 10 Record Settings

14. Click **Copy** to copy the settings to other channels, as shown in Figure 2. 11.



Figure 2. 11 Copy Record Settings

15. Click **OK** to complete the startup Setup Wizard.

2.3 Adding and Connecting the IP Cameras

2.3.1 Adding the Online IP Cameras

Purpose:

The main function of the NVR is to connect the network cameras and record the video got from it. So before you can get a live view or record of the video, you should add the network cameras to the connection list of the device.

Before you start:

Ensure the network connection is valid and correct. For detailed checking and configuring of the network, please see *Chapter Checking Network Traffic* and *Chapter Configuring Network Detection*.

- **OPTION 1:**

Steps:

1. Right-click the mouse when you in the live view mode to show the right-click menu.

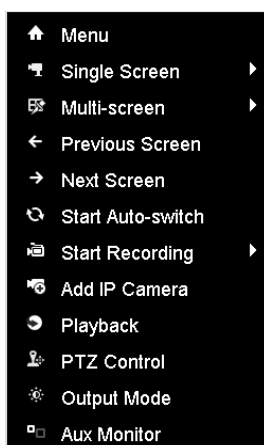



Figure 2. 12 Right-click Menu

2. Select **Add IP Camera** in the pop-up menu to enter the IP Camera Management interface.









Figure 2. 13 Adding IP Camera Interface

- The online cameras with same network segment will be displayed in the camera list. Click the  button to add the camera.

Or you can click the **One-touch Adding** button to add all the detected online IP cameras.

Table 2. 1 Explanation of the icons

Icon	Explanation	Icon	Explanation
	Edit basic parameters of the camera		Add the detected IP camera.
	The camera is connected.		The camera is disconnected; you can click the icon to get the exception information of camera.
	Delete the IP camera		Advanced settings of the camera.
	Update the IP camera		

- To add other IP cameras:

- Click the **Custom Adding** button to pop up the Add IP Camera (Custom) interface.

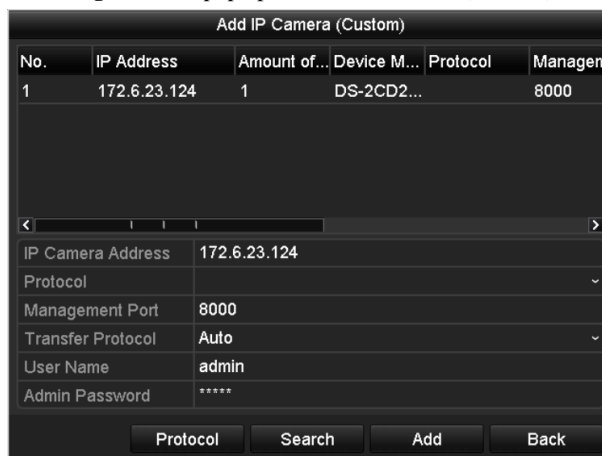

Figure 2. 14 Custom Adding IP Camera Interface

- You can edit the IP address, protocol, management port, and other information of the IP camera to be added.

- Click **Add** to add the camera.

• **OPTION 2:**

Steps:

- Enter the Camera Management interface.

Menu> Camera> Camera



Figure 2. 15 Main Menu

- Repeat the step 3 and 4 of OPTION 1 to add the camera.



Figure 2. 16 IP Camera Management Interface

Table 2. 2 Explanation of the icons

Icon	Explanation	Icon	Explanation
	Edit basic parameters of the camera		Add the detected IP camera.
	The camera is connected; you can click the icon to get the live view of the camera.		The camera is disconnected; you can click the icon to get the exception information of camera.
	Delete the IP camera		Advanced settings of the camera.
	Update the IP camera		

- (For the encoders with multiple channels only) check the checkbox of Channel No. in the pop-up window, as shown in the following figure, and click **OK** to finish adding.



Figure 2. 17 Selecting Multiple Channels

2.3.2 Editing the Connected IP Cameras and Configuring Customized Protocols

After the adding of the IP cameras, the basic information of the camera lists in the page, you can configure the basic setting of the IP cameras.

Steps:

1. Click the  icon to edit the parameters; you can edit the IP address, protocol and other parameters.

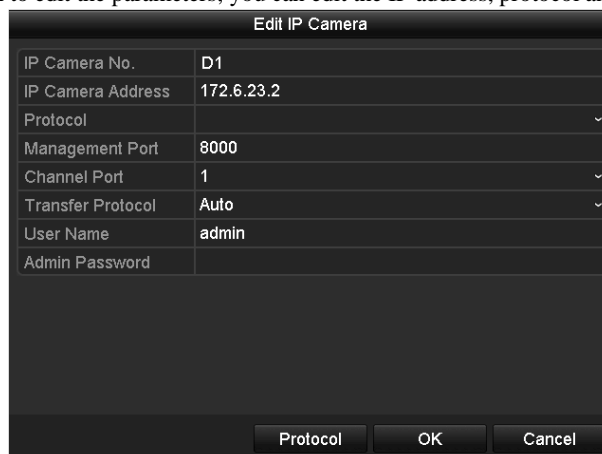

Edit IP Camera	
IP Camera No.	D1
IP Camera Address	172.6.23.2
Protocol	▼
Management Port	8000
Channel Port	1
Transfer Protocol	Auto
User Name	admin
Admin Password	

Figure 2. 18 Edit the Parameters

Channel Port: If the connected device is an encoding device with multiple channels, you can choose the channel to connect by selecting the channel port No. in the dropdown list.

Transfer Protocol: Auto, TCP and UDP are selectable; you can select the transfer protocol according to the network condition.

2. Click **OK** to save the settings and exit the editing interface.

To edit advanced parameters:

Steps:

1. Drag the horizontal scroll bar to the right side and click the  icon.

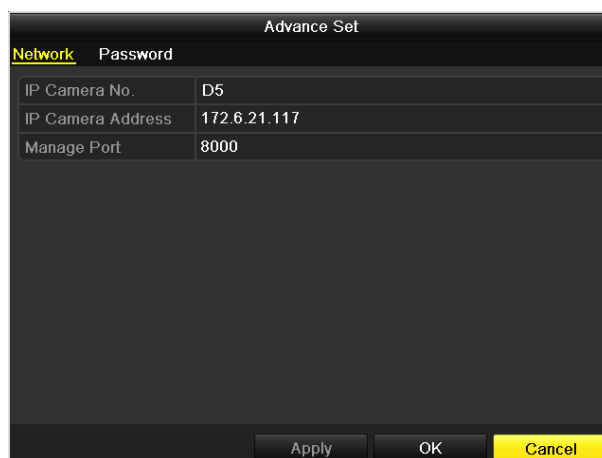

Advance Set	
Network	Password
IP Camera No.	D5
IP Camera Address	172.6.21.117
Manage Port	8000

Figure 2. 19 Network Configuration of the Camera

2. You can edit the network information and the password of the camera.

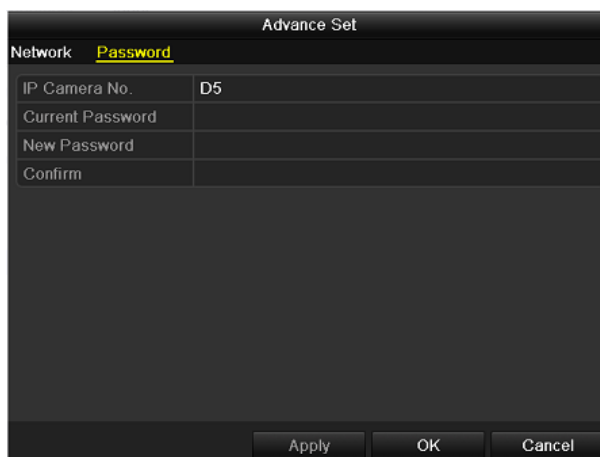

Figure 2. 20 Password Configuration of the Camera

3. Click **Apply** to save the settings and click **OK** to exit the interface.

Configuring the customized protocols

Purpose:

To connect the network cameras which are not configured with the standard protocols, you can configure the customized protocols for them.

Steps:

1. Click the **Protocol** button in the custom adding IP camera interface to enter the protocol management interface.

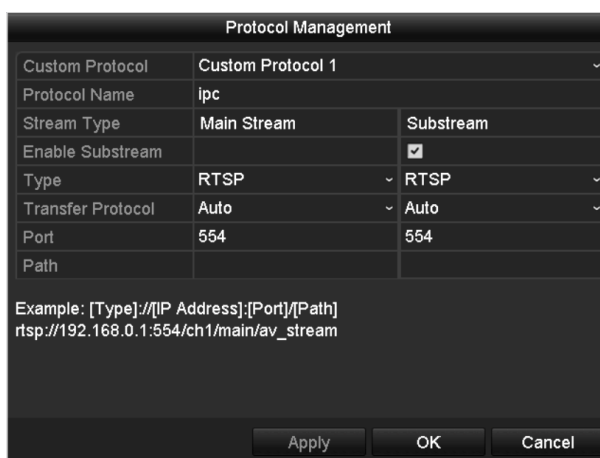

Figure 2. 21 Protocol Management Interface

There are 16 customized protocols provided in the system, you can edit the protocol name; and choose whether to enable the sub-stream.

2. Choose the protocol type of transmission and choose the transfer protocols.



Before customizing the protocol for the network camera, you have to contact the manufacturer of the network camera to consult the URL (uniform resource locator) for getting main stream and sub-stream.

Example: The format of the URL is: [Type]://[IP Address of the network camera]:[Port]/[Path]. E.g.,
rtsp://192.168.1.55:554/ch1/main/av_stream.

- **Protocol Name:** Edit the name for the custom protocol.
- **Enable Substream:** If the network camera does not support sub-stream or the sub-stream is not needed leave the checkbox empty.
- **Type:** The network camera adopting custom protocol must support getting stream through standard RTSP.
- **Transfer Protocol:** Select the transfer protocol for the custom protocol.
- **Port:** Set the port No. for the custom protocol.
- **Path:** Set the resource path for the custom protocol. E.g., ch1/main/av_stream.



The protocol type and the transfer protocols must be supported by the connected network camera. After adding the customized protocols, you can see the protocol name is listed in the dropdown list, please refer to Figure 2. 22.

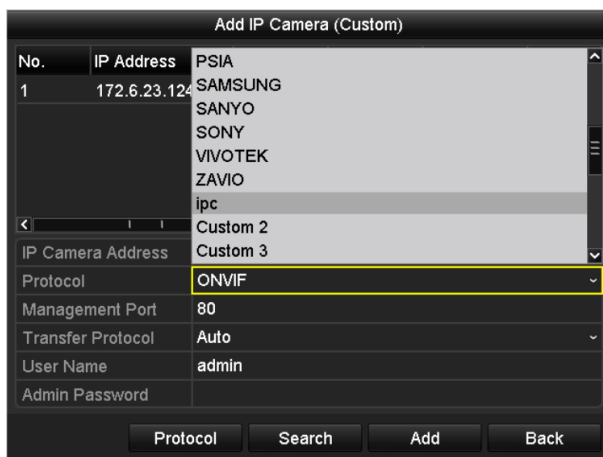

Figure 2. 22 Protocol Setting

3. Choose the protocols you just added to validate the connection of the network camera.

2.3.3 Editing IP Cameras Connected to the PoE Interfaces



This chapter is only applicable for DS-7600/7700NI-SP series NVR.

The PoE interfaces enables the NVR system to pass electrical power safely, along with data, on Ethernet cabling to the connected network cameras.

The DS-7600/7700NI-SP series NVR provides up to 16 PoE interfaces which can connect to 16 network cameras directly; and if you disable the PoE interface, you can also connect to the online network cameras. And the PoE interface supports the Plug-and-Play function.

Example:

As for 7608/7708NI-SP NVR, when you want to connect 2 online cameras and connect 6 network cameras via PoE interfaces, you must disable 2 PoE interfaces in the Edit IP Camera menu.

To add Cameras for NVR supporting PoE function:

Before you start:

Connect the network cameras via the PoE interfaces.

Steps:

1. Enter the Camera Management interface.

Menu> Camera> Camera

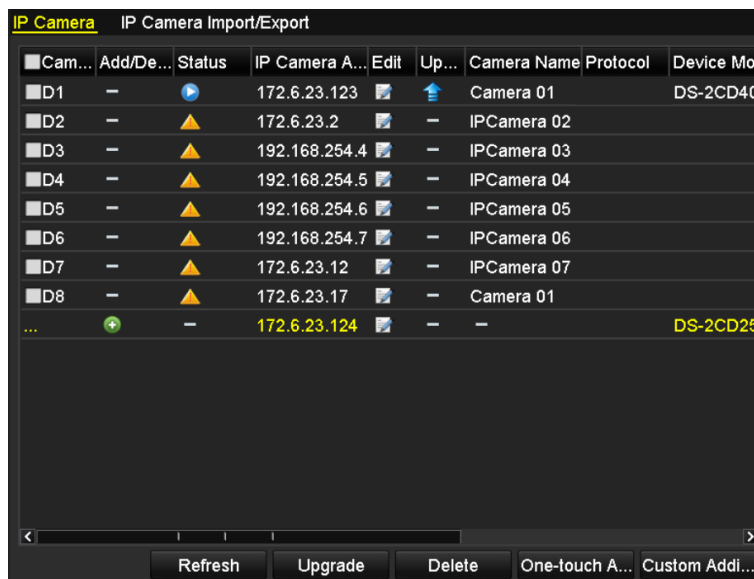

Figure 2. 23 List of Connected Cameras



The cameras connecting to the PoE interface cannot be deleted in this menu.

2. Click the button, and select the Adding Method in the drop-down list.
 - **Plug-and-Play:** It means that the camera is connected to the PoE interface, so in this case, the parameters of the camera can't be edited. The IP address of the camera can only be edited in the Network Configuration interface, see *Chapter 9.1 Configuring General Settings* for detailed information.

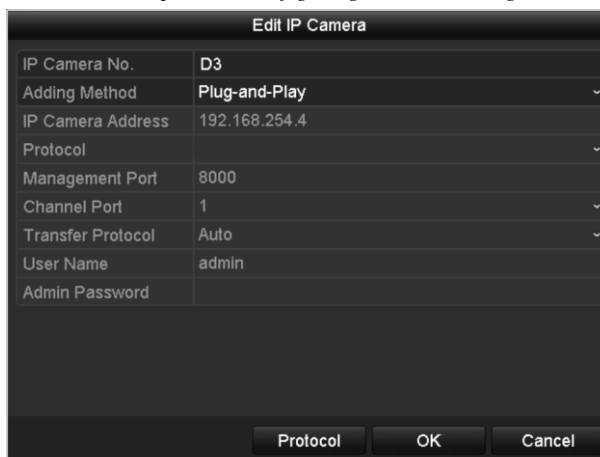

Figure 2. 24 Edit IP Camera Interface - Plug-and-Play

- **Manual:** You can disable the PoE interface by selecting the manual while the current channel can be used as a normal channel and the parameters can also be edited.
Input the IP address, the user name and password of administrator manually, and click **OK** to add the IP camera.

The screenshot shows a dark-themed dialog box titled "Edit IP Camera". It contains a table with the following fields and values:

Field	Value
IP Camera No.	D1
Adding Method	Manual
IP Camera Address	172.6.23.123
Protocol	
Management Port	8000
Channel Port	1
Transfer Protocol	Auto
User Name	admin
Admin Password	*****

At the bottom of the dialog box, there are three buttons: "Protocol", "OK", and "Cancel".

Figure 2. 25 Edit IP Camera Interface - Manual

Chapter 3 Live View





3.1 Introduction of Live View

Live view shows you the video image getting from each camera in real time. The NVR automatically enters Live View mode when powered on. It is also at the very top of the menu hierarchy, thus pressing the ESC many times (depending on which menu you're on) brings you to the Live View mode.

Live View Icons

In the live view mode, there are icons at the upper-right of the screen for each channel, showing the status of the record and alarm in the channel, so that you can know whether the channel is recorded, or whether there are alarms occur as soon as possible.

Table 3.1 Description of Live View Icons

Icons	Description
	Alarm (video loss, video tampering, motion detection or sensor alarm)
	Record (manual record, schedule record, motion detection or alarm triggered record)
	Alarm & Record
	Event/Exception (motion detection, sensor alarm or exception information, appears at the lower-left corner of the screen. Please refer to <i>Chapter 8.7 Setting Alarm Response Actions</i> for details.)

3.2 Operations in Live View Mode

In live view mode, there are many functions provided. The functions are listed below.

- **Single Screen:** showing only one screen on the monitor.
- **Multi-screen:** showing multiple screens on the monitor simultaneously.
- **Auto-switch:** the screen is auto switched to the next one. And you must set the dwell time for each screen on the configuration menu before enabling the auto-switch.

Menu>Configuration>Live View>Dwell Time.

- **Start Recording:** continuous record and motion detection record are supported.
- **Output Mode:** select the output mode to Standard, Bright, Gentle or Vivid.
- **Add IP Camera:** the shortcut to the IP camera management interface.
- **Playback:** playback the recorded videos for current day.
- **Aux/Main output switch:** the NVR checks the connection of the output interfaces to define the main and auxiliary output interfaces. The priority level for the main and aux output is HDMI>VGA>CVBS. This means if the HDMI is used, it will be the main output. If the HDMI is not used, the VGA output will be the main output. See the table below.

Table 3.2 Priorities of Interfaces

	HDMI	VGA	CVBS	Main output	Auxiliary output
1	√	√	√	HDMI	VGA
2	√	×	√	HDMI	CVBS
3	×	√	√	VGA	CVBS
4	×	×	√	CVBS	

- √ means the interface is in use, × means the interface is out of use or the connection is invalid. And the HDMI, VGA and CVBS can be used at the same time.

When the aux output is enabled, the main output can't do any operation, and you can do some basic operation on the live view mode for the Aux output.



For DS-7600NI-ST/SP, there is only one audio output, the VGA output has a higher priority over CVBS output. When you enable the audio in both the CVBS and VGA audio output, the audio from the audio out interface is for VGA.

3.2.1 Front Panel Operation on Live View

Table 3.3 Front Panel Operation in Live View

Functions	Front Panel Operation
Show single screen	Press the corresponding Alphanumeric button. E.g. Press 2 to display only the screen for channel 2.
Show multi-screen	Press the PREV/FOCUS- button.
Manually switch screens	Next screen: right/down direction button. Previous screen: left/up direction button.

Functions	Front Panel Operation
Auto-switch	Press Enter button.
Playback	Press Play button.
Switch between main and aux output	Press Main/Aux button.

3.2.2 Using the Mouse in Live View

Table 3. 4 Mouse Operation in Live View

Name	Description
Menu	Enter the main menu of the system by right clicking the mouse.
Single Screen	Switch to the single full screen by choosing channel number from the dropdown list.
Multi-screen	Adjust the screen layout by choosing from the dropdown list.
Previous Screen	Switch to the previous screen.
Next Screen	Switch to the next screen.
Start/Stop Auto-switch	Enable/disable the auto-switch of the screens.
Start Recording	Start continuous recording or motion detection recording of all channels.
Add IP Camera	Enter the IP Camera Management interface, and manage the cameras.
Playback	Enter the playback interface and start playing back the video of the selected channel immediately.
PTZ	Enter the PTZ control interface.
Output Mode	Four modes of output supported, including Standard, Bright, Gentle and Vivid.
Aux Monitor	Switch to the auxiliary output mode and the operation for the main output is disabled.



- The *dwelt time* of the live view configuration must be set before using **Start Auto-switch**.
- If you enter Aux monitor mode and the Aux monitor is not connected, the mouse operation is disabled; you need to switch back to the Main output with the MAIN/AUX button on the front panel or remote.
- If the corresponding camera supports intelligent function, the Reboot Intelligence option is included when right-clicking mouse on this camera.

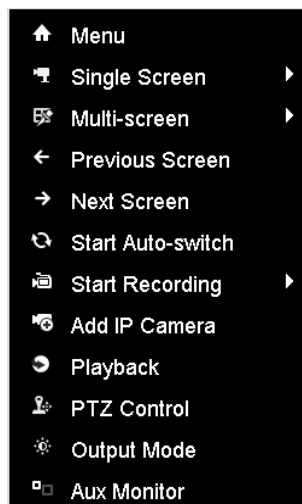

Figure 3. 1 Right-click Menu

3.2.3 Using an Auxiliary Monitor

Certain features of the Live View are also available while in an Aux monitor. These features include:

- **Single Screen:** Switch to a full screen display of the selected camera. Camera can be selected from a dropdown list.
- **Multi-screen:** Switch between different display layout options. Layout options can be selected from a dropdown list.
- **Next Screen:** When displaying less than the maximum number of cameras in Live View, clicking this feature will switch to the next set of displays.
- **Playback:** Enter into Playback mode.
- **PTZ Control:** Enter PTZ Control mode.
- **Main Monitor:** Enter Main operation mode.



In the live view mode of the main output monitor, the menu operation is not available while Aux output mode is enabled.

3.2.4 Quick Setting Toolbar in Live View Mode

On the screen of each channel, there is a quick setting toolbar which shows when you single click the mouse in the corresponding screen.



Figure 3. 2 Quick Setting Toolbar

Table 3. 5 Description of Quick Setting Toolbar Icons

Icon	Description	Icon	Description	Icon	Description
	Enable/Disable Manual Record		Instant Playback		Mute/Audio on
	Capture		PTZ Control		Digital Zoom
	Image Settings		Live View Strategy		Stream Information
	Close				

Instant Playback only shows the record in last five minutes. If no record is found, it means there is no record during the last five minutes.

Digital Zoom can zoom in the selected area to the full screen. You can left-click and draw to select the area to zoom in, as shown in Figure 3. 3.



Figure 3. 3 Digital Zoom

Image Settings icon can be selected to enter the Image Settings menu.

You can set the image parameters like brightness, contrast, saturation and hue according to the actual demand.

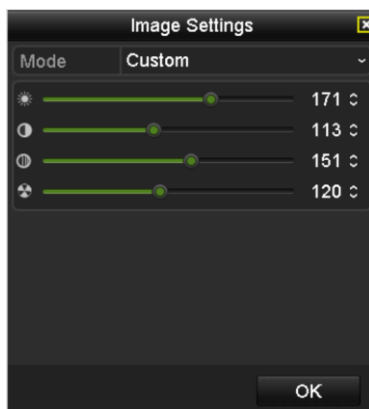

Figure 3. 4 Image Settings- Customize



Live View Strategy can be selected to set strategy, including Real-time, Balanced, Fluency.

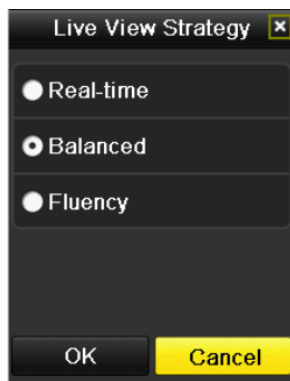

Figure 3. 5 Live View Strategy



Move the mouse onto the icon to show the real-time stream information, including the frame rate, bitrate and resolution.



Figure 3. 6 Information

3.3 Adjusting Live View Settings

Purpose:

Live View settings can be customized according to different needs. You can configure the output interface, dwell time for screen to be shown, mute or turning on the audio, the screen number for each channel, etc.

Steps:

1. Enter the Live View Settings interface.

Menu> Configuration> Live View

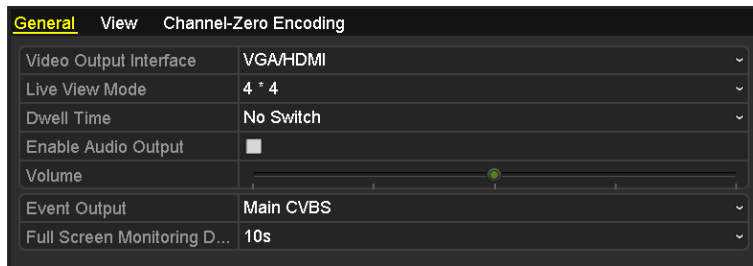

Figure 3.7 Live View-General

The settings available in this menu include:

- **Video Output Interface:** Designates the output to configure the settings for. Outputs include HDMI (depends on the model), VGA, Main CVBS and Spot Output.



No CVBS spot out for DS-7600NI-ST/SP series NVR.

- **Live View Mode:** Designates the display mode to be used for Live View.
- **Dwell Time:** The time in seconds to *dwell* between switching of channels when enabling auto-switch in Live View.
- **Enable Audio Output:** Enables/disables audio output for the selected video output.
- **Volume:** Adjust the volume of live view, playback and two-way audio for the selected output interface.
- **Event Output:** Designates the output to show event video.
- **Full Screen Monitoring Dwell Time:** The time in seconds to show alarm event screen.

2. Setting Cameras Order

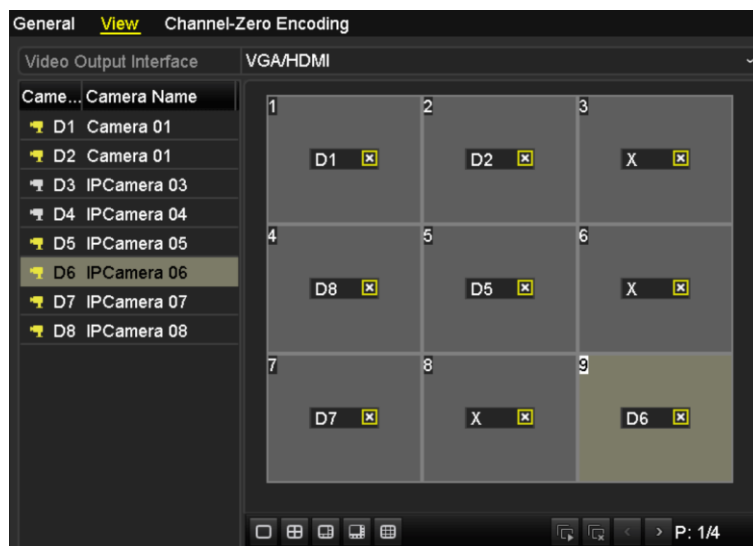





Figure 3.8 Live View- Camera Order

- 1) Select a **View** mode in , including 1/4/6/8/16/25/32/36/64-window division modes are supported.
- 2) Select the small window, and double-click on the channel number to display the channel on the window.
You can click  button to start live view for all the channels and click  to stop all the live view.
- 3) Click the **Apply** button to save the setting.

You can also click-and-drag the camera to the desired window on the live view interface to set the camera order.

3.4 Channel-zero Encoding

Purpose:

Sometimes you need to get a remote view of many channels in real time from web browser or CMS (Client Management System) software, in order to decrease the bandwidth requirement without affecting the image quality, channel-zero encoding is supported as an option for you.

Steps:

1. Enter the **Live View** Settings interface.
Menu > Configuration> Live View
2. Select the **Channel-Zero Encoding** tab.

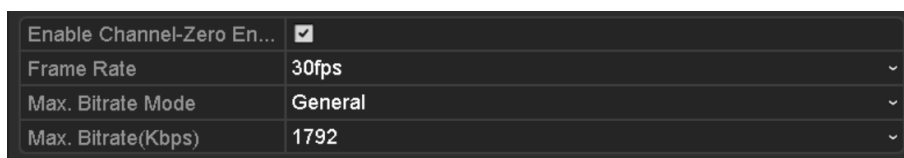

Figure 3. 9 Live View- Channel-Zero Encoding

3. Check the checkbox after **Enable Channel Zero Encoding**.
4. Configure the Frame Rate, Max. Bitrate Mode and Max. Bitrate.

After you set the Channel-Zero encoding, you can get a view in the remote client or web browser of 16 channels in one screen.

3.5 User Logout

Purpose:

After logging out, the monitor turns to the live view mode and if you want to do some operation, you need to enter user name and password to log in again.

Steps:

1. Enter the Shutdown menu.

Menu>Shutdown

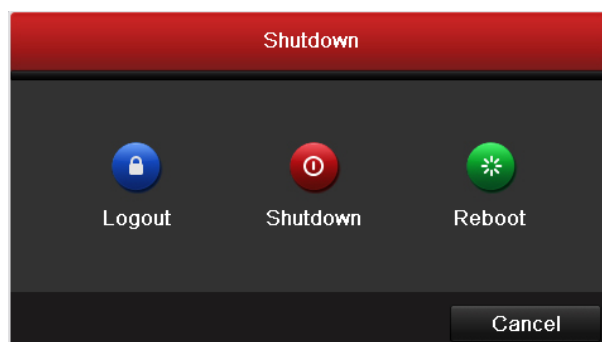

Figure 3. 10 Shutdown

2. Click **Logout**.



After you have logged out the system, menu operation on the screen is invalid. It is required to input a user name and password to unlock the system.

Chapter 4 PTZ Controls

4.1 Configuring PTZ Settings

Purpose:

Follow the procedure to set the parameters for PTZ. The configuring of the PTZ parameters should be done before you control the PTZ camera.

Steps:

1. Enter the PTZ Settings interface.

Menu >Camera> PTZ



Figure 4. 1 PTZ Settings

2. Click the RS-485 Settings button to set the RS-485 parameters.



Figure 4. 2 PTZ- General

3. Choose the camera for PTZ setting in the **Camera** dropdown list.
4. Enter the parameters of the PTZ camera.



All the parameters should be exactly the same as the PTZ camera parameters.

5. Click **Apply** button to save the settings.

4.2 Setting PTZ Presets, Patrols & Patterns

Before you start:

Please make sure that the presets, patrols and patterns should be supported by PTZ protocols.

4.2.1 Customizing Presets

Purpose:

Follow the steps to set the Preset location which you want the PTZ camera to point to when an event takes place.

Steps:

1. Enter the PTZ Control interface.
Menu>Camera>PTZ



Figure 4. 3 PTZ Settings

2. Use the directional button to wheel the camera to the location where you want to set preset; and the zoom and focus operations can be recorded in the preset as well.
3. Enter the preset No. (1~255) in the preset text field, and click the **Set** button to link the location to the preset. Repeat the steps2-3 to save more presets.
You can click the **Clear** button to clear the location information of the preset, or click the **Clear All** button to clear the location information of all the presets.

4.2.2 Calling Presets

Purpose:

This feature enables the camera to point to a specified position such as a window when an event takes place.

Steps:

1. Click the button **PTZ** in the lower-right corner of the PTZ setting interface;

Or press the PTZ button on the front panel or click the PTZ Control icon  in the quick setting bar, or select the PTZ option in the right-click menu to show the PTZ control panel.

2. Choose **Camera** in the dropdown list.
3. Click the  button to show the general settings of the PTZ control.



Figure 4. 4 PTZ Panel - General

4. Click to enter the preset No. in the corresponding text field.
5. Click the **Call Preset** button to call it.

4.2.3 Customizing Patrols

Purpose:

Patrols can be set to move the PTZ to different key points and have it stay there for a set duration before moving on to the next key point. The key points are corresponding to the presets. The presets can be set following the steps above in *Customizing Presets*.

Steps:

1. Enter the PTZ Control interface.
Menu>Camera>PTZ



Figure 4. 5 PTZ Settings

2. Select patrol No. in the drop-down list of patrol.

3. Click the **Set** button to add key points for the patrol.

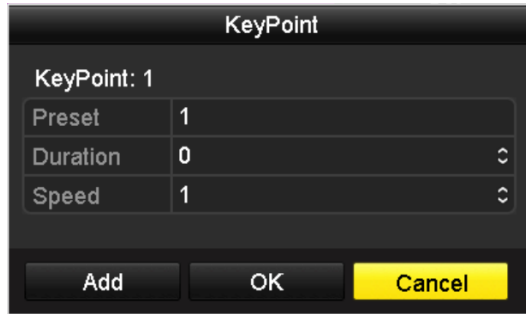

Figure 4. 6 Key point Configuration

4. Configure key point parameters, such as the key point No., duration of staying for one key point and speed of patrol. The key point is corresponding to the preset. The **Key Point No.** determines the order at which the PTZ will follow while cycling through the patrol. The **Duration** refers to the time span to stay at the corresponding key point. The **Speed** defines the speed at which the PTZ will move from one key point to the next.
5. Click the **Add** button to add the next key point to the patrol, or you can click the **OK** button to save the key point to the patrol.
You can delete all the key points by clicking the **Clear** button for the selected patrol, or click the **Clear All** button to delete all the key pints for all patrols.

4.2.4 Calling Patrols

Purpose:

Calling a patrol makes the PTZ to move according the predefined patrol path.

Steps:



1. Click the button **PTZ** in the lower-right corner of the PTZ setting interface;
Or press the PTZ button on the front panel or click the PTZ Control icon  in the quick setting bar, or select the PTZ option in the right-click menu to show the PTZ control panel.
2. Click the  button to show the general settings of the PTZ control.



Figure 4. 7 PTZ Panel - General

3. Select a patrol in the dropdown list and click the **Call Patrol** button to call it.

- You can click the **Stop Patrol** button to stop calling it.

4.2.5 Customizing Patterns

Purpose:

Patterns can be set by recording the movement of the PTZ. You can call the pattern to make the PTZ movement according to the predefined path.

Steps:

- Enter the PTZ Control interface.
Menu > Camera > PTZ



Figure 4. 8 PTZ Settings

- Choose pattern number in the dropdown list.
- Click the **Start** button and click corresponding buttons in the control panel to move the PTZ camera, and click the **Stop** button to stop it.
The movement of the PTZ is recorded as the pattern.

4.2.6 Calling Patterns

Purpose:

Follow the procedure to move the PTZ camera according to the predefined patterns.

Steps:



- Click the button **PTZ** in the lower-right corner of the PTZ setting interface;
Or press the PTZ button on the front panel or click the PTZ Control icon  in the quick setting bar, or select the PTZ option in the right-click menu to show the PTZ control panel.
- Click the  button to show the general settings of the PTZ control.



Figure 4. 9 PTZ Panel - General

3. Click the **Call Pattern** button to call it.
4. Click the **Stop Pattern** button to stop calling it.

4.2.7 Customizing Linear Scan Limit

Purpose:

The Linear Scan can be enabled to trigger the scan in the horizontal direction in the predefined range.



This function is supported by some certain models.

Steps:

1. Enter the PTZ Control interface.
Menu > Camera > PTZ



Figure 4. 10 PTZ Settings

2. Use the directional button to wheel the camera to the location where you want to set the limit, and click the **Left Limit** or **Right Limit** button to link the location to the corresponding limit.



The speed dome starts linear scan from the left limit to the right limit, and you must set the left limit on the left side of the right limit, as well the angle from the left limit to the right limit should be no more than 180°.

4.2.8 Calling Linear Scan

Purpose:

Follow the procedure to call the linear scan in the predefined scan range.

Steps:



1. Click the button **PTZ** in the lower-right corner of the PTZ setting interface;
Or press the PTZ button on the front panel or click the PTZ Control icon  in the quick setting bar to enter the PTZ setting menu in live view mode.
2. Click the  button to show the one-touch function of the PTZ control.



Figure 4. 11 PTZ Panel - One-touch

3. Click **Linear Scan** button to start the linear scan and click the Linear Scan button again to stop it.
You can click the **Restore** button to clear the defined left limit and right limit data and the dome needs to reboot to make settings take effect.

4.2.9 One-touch Park

Purpose:

For some certain model of the speed dome, it can be configured to start a predefined park action (scan, preset, patrol and etc.) automatically after a period of inactivity (park time).

Steps:



1. Click the button **PTZ** in the lower-right corner of the PTZ setting interface;
Or press the PTZ button on the front panel or click the PTZ Control icon  in the quick setting bar to enter the PTZ setting menu in live view mode.
2. Click the  button to show the one-touch function of the PTZ control.



Figure 4. 12 PTZ Panel - One-touch

3. There are 3 one-touch park types selectable, click the corresponding button to activate the park action.

Park (Quick Patrol): The dome starts patrol from the predefined preset 1 to preset 32 in order after the park time. The undefined preset will be skipped.

Park (Patrol 1): The dome starts move according to the predefined patrol 1 path after the park time.

Park (Preset 1): The dome moves to the predefined preset 1 location after the park time.



The park time can only be set through the speed dome configuration interface, by default the value is 5s.

4. Click the button again to inactivate it.

4.3 PTZ Control Panel

To enter the PTZ control panel, there are two ways supported.

OPTION 1:

In the PTZ settings interface, click the **PTZ** button on the lower-right corner which is next to the Back button.

OPTION 2:

In the Live View mode, you can press the PTZ Control button on the front panel or on the remote control, or choose the PTZ Control icon , or select the PTZ option in the right-click menu.

Click the **Configuration** button on the control panel, and you can enter the PTZ Settings interface.

















In PTZ control mode, the PTZ panel will be displayed when a mouse is connected with the device. If no mouse is connected, the **PTZ** icon appears in the lower-left corner of the window, indicating that this camera is in PTZ control mode.

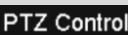
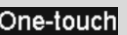
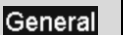

Figure 4. 13 PTZ Panel

Table 4. 1 Description of the PTZ panel icons

Icon	Description	Icon	Description	Icon	Description
	Direction button and the auto-cycle button		Zoom+, Focus+, Iris+		Zoom-, Focus-, Iris-
	The speed of the PTZ movement		Light on/off		Wiper on/off
	3D-Zoom		Image Centralization		Menu
	Switch to the PTZ control interface		Switch to the one-touch control interface		Switch to the general settings interface
	Previous item		Next item		Start pattern / patrol
	Stop the patrol / pattern movement		Exit		Minimize windows

Chapter 5 Recording and Capture Settings

5.1 Configuring Parameters

Purpose:

By configuring the parameters you can define the parameters which affect the image quality, such as the transmission stream type, the resolution and so on.

Before you start:

1. Make sure that the HDD has already been installed. If not, please install a HDD and initialize it.
(Menu>HDD>General)

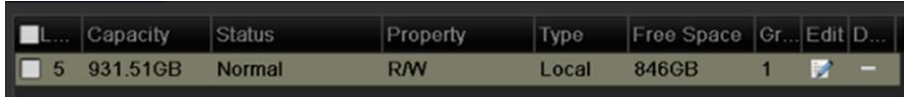

Figure 5. 1 HDD- General

2. Check the storage mode of the HDD
 - 1) Click **Advanced** to check the storage mode of the HDD.
 - 2) If the HDD mode is *Quota*, please set the maximum record capacity and maximum picture capacity. For detailed information, see *Chapter Configuring Quota Mode*.
 - 3) If the HDD mode is **Group**, you should set the HDD group. For detailed information, see *Chapter Configuring HDD Group for Recording and Capture*.

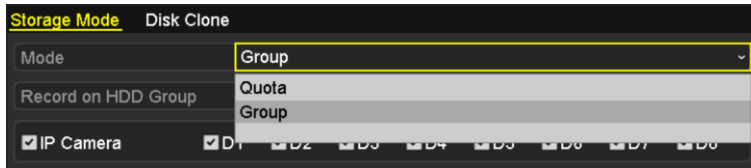

Figure 5. 2 HDD- Advanced

Steps:

1. Enter the Record settings interface to configure the recording parameters:
Menu>Record>Parameters

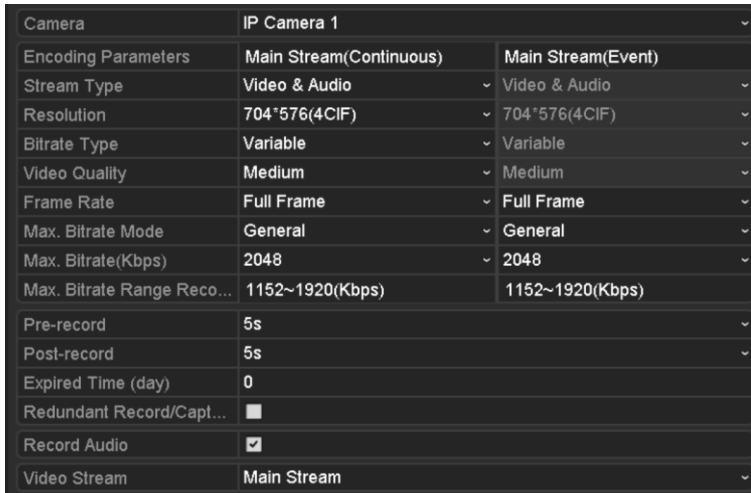

Figure 5. 3 Recording Parameters

2. Parameters Setting for Recording

- 1) Select **Record** tab page to configure. You can configure the stream type, the resolution, and other parameters on your demand.
 - **Pre-record:** The time you set to record before the scheduled time or event. For example, when an alarm triggered the recording at 10:00, if you set the pre-record time as 5 seconds, the camera records it at 9:59:55.
 - **Post-record:** The time you set to record after the event or the scheduled time. For example, when an alarm triggered the recording ends at 11:00, if you set the post-record time as 5 seconds, it records till 11:00:05.
 - **Expired Time:** The expired time is the longest time for a record file to be kept in the HDD, if the deadline is reached, the file will be deleted. You can set the expired time to 0, and then the file will not be deleted. The actual keeping time for the file should be determined by the capacity of the HDD.
 - **Redundant Record/ Capture:** Enabling redundant record or capture means you save the record and captured picture in the redundant HDD. See *Chapter Configuring Redundant Recording and Capture*.
 - **Record Audio:** Check the checkbox to enable or disable audio recording.
 - **Video Stream:** Main stream and sub-stream are selectable for recording. When you select sub-stream, you can record for a longer time with the same storage space.
- 2) Click **Apply** to save the settings.



- The redundant record/capture is to decide whether you want the camera to save the record files or captured pictures in the redundant HDD. You must configure the redundant HDD in HDD settings. For detailed information, see *Chapter 12.4.2*.
- The parameters of Main Stream (Event) are read-only.

3. Parameters Settings for Sub-stream

- 1) Enter the Sub-stream tab page.

Camera	IP Camera 1
Stream Type	Video
Resolution	352*288(CIF)
Bitrate Type	Variable
Video Quality	Medium
Frame Rate	Full Frame
Max. Bitrate Mode	General
Max. Bitrate(Kbps)	256
Max. Bitrate Range Reco...	384~640(Kbps)

Figure 5. 4 Sub-stream Parameters

- 2) Configure the parameters of the camera.
 - 3) Click **Apply** to save the settings.
- ### 4. Parameters Settings for Capture
- 1) Select the **Capture** tab.

Camera	IP Camera 4	Event
Parameter Type	Continuous	Event
Resolution	704*480(4CIF)	704*480(4CIF)
Picture Quality	Medium	Medium
Interval	2s	2s

Figure 5. 5 Capture Parameters

- 2) Configure the parameters.
- 3) Click **Apply** to save the settings.



The interval is the time period between two capturing actions. You can configure all the parameters on this menu on your demand.

5.2 Configuring Recording/Capture Schedule

Purpose:

Set the record schedule, and then the camera automatically starts/stops recording according to the configured schedule.



In this chapter, we take the record schedule procedure as an example, and the same procedure can be applied to configure schedule for both recording and capture. To schedule the automatic capture, you need to choose the Capture tab in the **Schedule** interface.

Steps:

1. Enter the Record Schedule interface.
Menu>Record/Capture>Schedule
2. Configure Record Schedule
 - 1) Select Record/Capture Schedule.

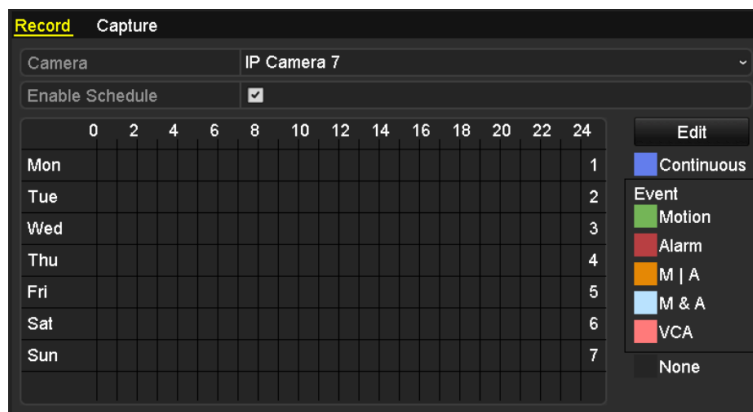

Figure 5.6 Record Schedule

- 2) Choose the camera you want to configure.
- 3) Select the check box after the **Enable Schedule** item.
- 4) Click **Edit** button or click on the color icon under the edit button and draw the schedule line on the panel.

Edit the schedule:

- I. In the message box, you can choose the day to which you want to set schedule.

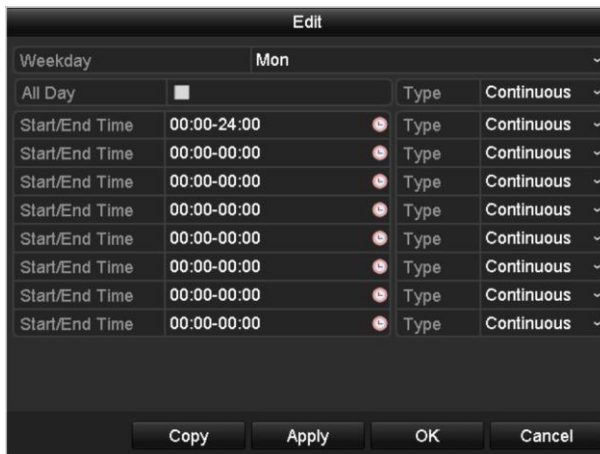



Figure 5.7 Recording Schedule Interface

You can click the  button to set the accurate time of the schedule.

II. To schedule an all-day recording, check the checkbox after the **All Day** item.

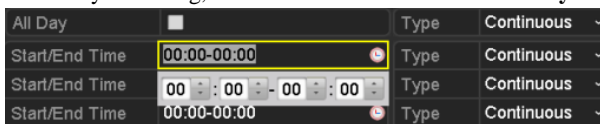

Figure 5.8 Edit Schedule

III. To arrange other schedule, leave the **All Day** checkbox blank and set the Start/End time.



Up to 8 periods can be configured for each day. And the time periods can't be overlapped each other.

IV. Select the record type in the dropdown list.



- To enable Motion, Alarm, M | A (motion or alarm), M & A (motion and alarm) and VCA (Video Content Analysis) triggered recording and capture, you must configure the motion detection settings, alarm input settings or VCA settings as well. For detailed information, refer to *Chapter 8.1*, *Chapter 8.2* and *Chapter 8.5*.
- The VCA settings are only available to the smart IP cameras.

Repeat the above edit schedule steps to schedule recording or capture for other days in the week. If the schedule can also be applied to other days, click **Copy**.

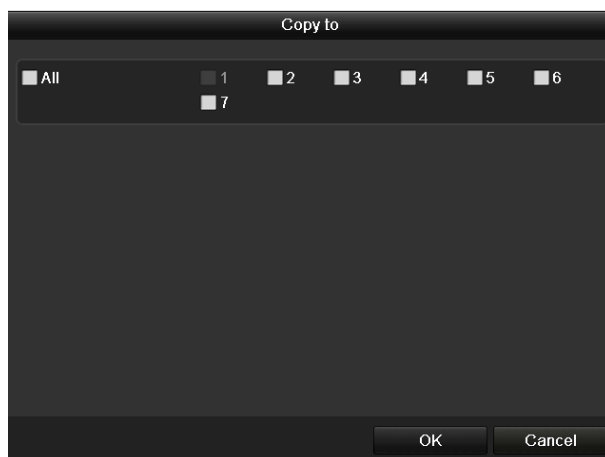

Figure 5.9 Copy Schedule to Other Days

- V. Click **OK** to save setting and back to upper level menu.
- VI. Click **Apply** in the Record Schedule interface to save the settings.

Draw the schedule:

- I. Click on the color icons, you can choose the schedule type as continuous or event.

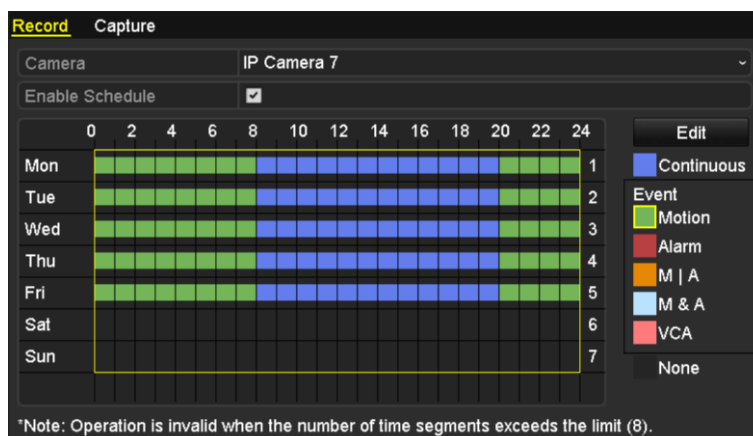

Figure 5.10 Draw the Schedule

Descriptions of the color icons are shown in the figure below.

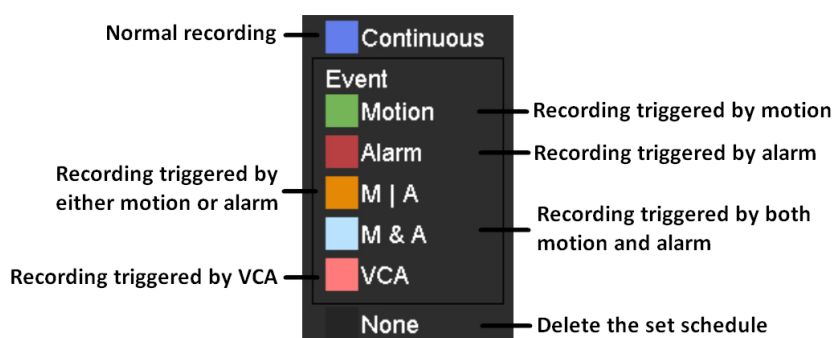

Figure 5.11 Descriptions of the color icons

- II. Click the **Apply** button to validate the settings.
- 3. (Optional) If the settings can also be used to other channels, click **Copy**, and then choose the channel to which you want to copy.

4. Click **Apply** to save the settings.



Figure 5. 12 Copy Schedule to Other Channels

5.3 Configuring Motion Detection Recording and Capture

Purpose:

Follow the steps to set the motion detection parameters. In the live view mode, once a motion detection event takes place, the NVR can analyze it and do many actions to handle it. Enabling motion detection function can trigger certain channels to start recording, or trigger full screen monitoring, audio warning, notify the surveillance center and so on. In this chapter, you can follow the steps to schedule a record which triggered by the detected motion.

Steps:

1. Enter the Motion Detection interface.

Menu>Camera>Motion

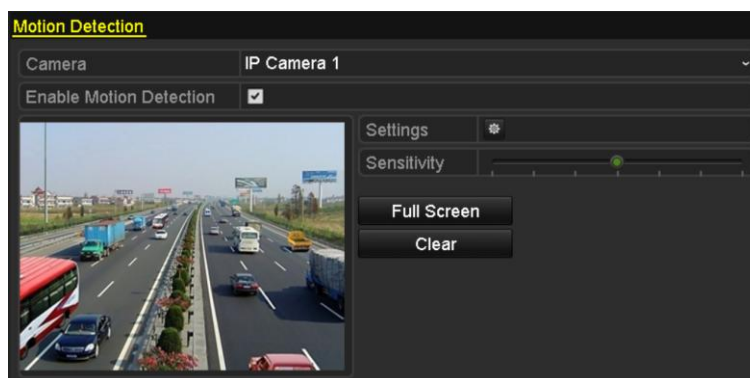

Figure 5.13 Motion Detection

2. Configure Motion Detection:

- 1) Choose camera you want to configure.
- 2) Check the checkbox after **Enable Motion Detection**.
- 3) Drag and draw the area for motion detection by mouse. If you want to set the motion detection for all the area shot by the camera, click **Full Screen**. To clear the motion detection area, click **Clear**.

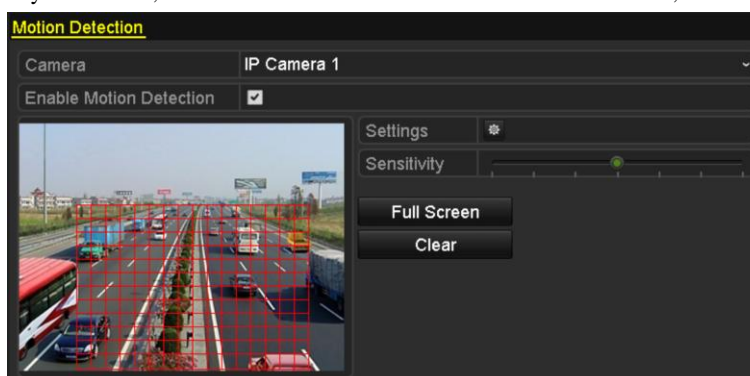

Figure 5.14 Motion Detection- Mask

- 4) Click **Settings**, and the message box for channel information pop up.

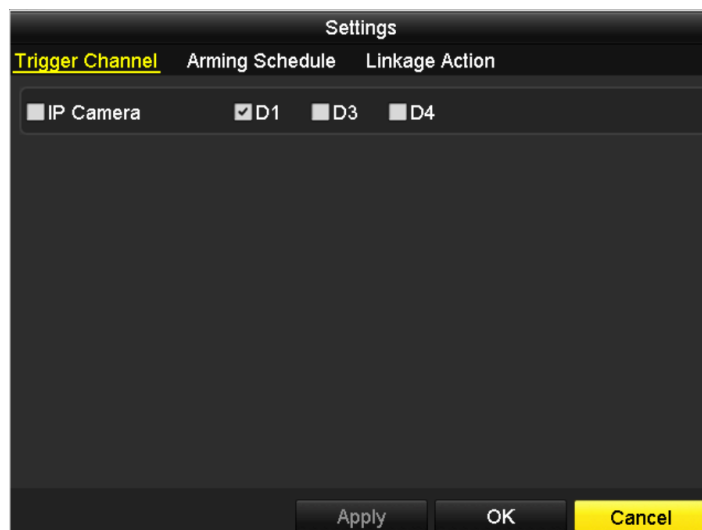

Figure 5. 15 Motion Detection Handling

-
- 5) Select the channels which you want the motion detection event to trigger recording.
 - 6) Click **Apply** to save the settings.
 - 7) Click **OK** to back to the upper level menu.
 - 8) Exit the Motion Detection menu.
3. Edit the Motion Detection Record Schedule. For the detailed information of schedule configuration, see *Chapter Configuring Recording/Capture Schedule*.

5.4 Configuring Alarm Triggered Recording and Capture

Purpose:

Follow the procedure to configure alarm triggered recording or capture.

Steps:

1. Enter the Alarm setting interface.

Menu> Configuration> Alarm

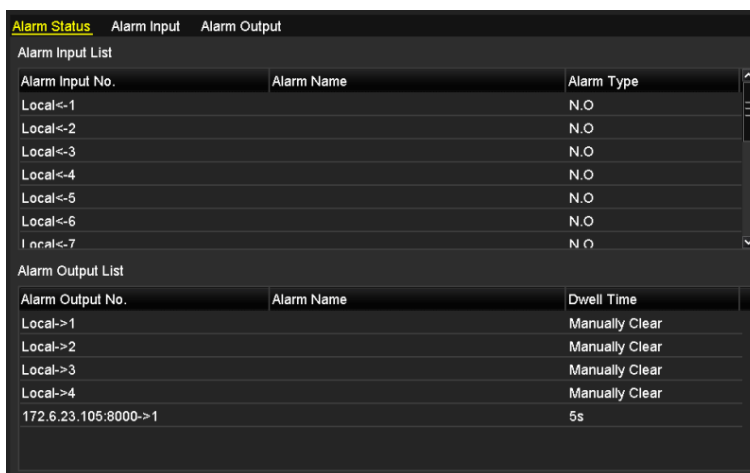

Figure 5. 16 Alarm Settings

2. Click **Alarm Input**.

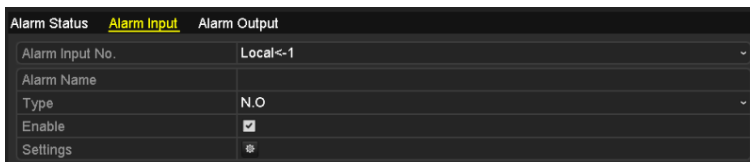

Figure 5. 17 Alarm Settings- Alarm Input

- 1) Select Alarm Input number and configure alarm parameters.
- 2) Choose N.O (normally open) or N.C (normally closed) for alarm type.
- 3) Check the checkbox for Setting .
- 4) Click **Settings**.

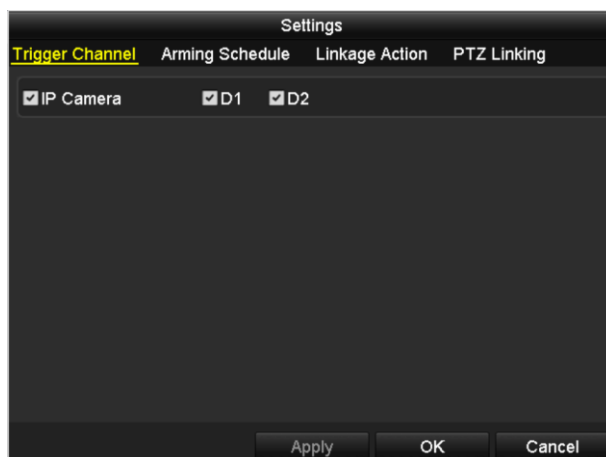

Figure 5. 18 Alarm Settings

- 5) Choose the alarm triggered recording channel.
- 6) Check the checkbox to select channel.
- 7) Click **Apply** to save settings.
- 8) Click **OK** to back to the upper level menu.

Repeat the above steps to configure other alarm input parameters.

If the settings can also be applied to other alarm inputs, click **Copy** and choose the alarm input number.



Figure 5. 19 Copy Alarm Input

3. Edit the Alarm triggered record in the Record/Capture Schedule setting interface. For the detailed information of schedule configuration, see *Chapter Configuring Recording/Capture Schedule*.

5.5 Manual Recording and Continuous Capture

Purpose:

Follow the steps to set parameters for the manual recording and continuous capture. Using manual recording and continuous capture, you need to manually cancel the record and capture. The manual recording and manual continuous capture is prior to the scheduled recording and capture.

Steps:

1. Enter the Manual settings interface.
Menu> Manual
Or press the **REC/SHOT** button on the front panel.

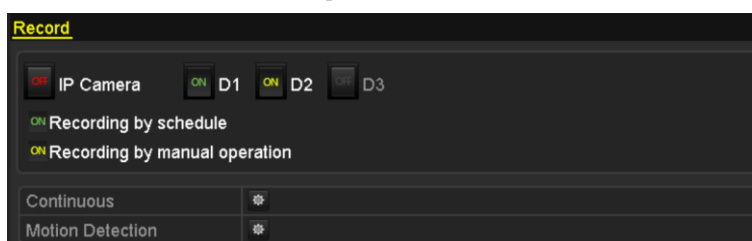

Figure 5. 20 Manual Record

2. Enable the Manual Recording.
 - 1) Select **Record** on the left bar.
 - 2) Click the status button before camera number to change **OFF** to **ON**.
3. Disable manual record.
Click the status button to change **ON** to **OFF**.



Green icon **ON** means that the channel is configured the record schedule. After rebooting, all the manual records enabled will be canceled.

4. Enabling and disabling the continuous capture
 - 1) Select **Continuous Capture** on the left bar.

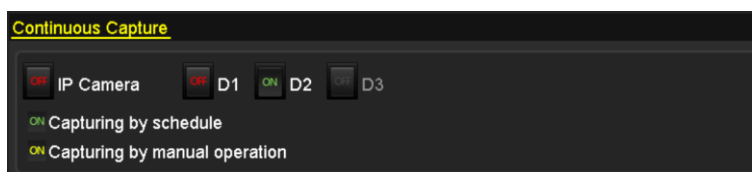



Figure 5. 21 Continuous Capture

- 2) Click the status button before camera number to change **OFF** to **ON**.
- 3) Disable continuous capture.
- 4) Click the status button to change **ON** to **OFF**.



Green icon  means that the channel is configured the capture schedule. After rebooting, all the continuous capture will be canceled.

5.6 Configuring Holiday Recording and Capture

Purpose:

Follow the steps to configure the record or capture schedule on holiday for that year. You may want to have different plan for recording and capture on holiday.

Steps:

1. Enter the Record setting interface.

Menu > Record > Holiday

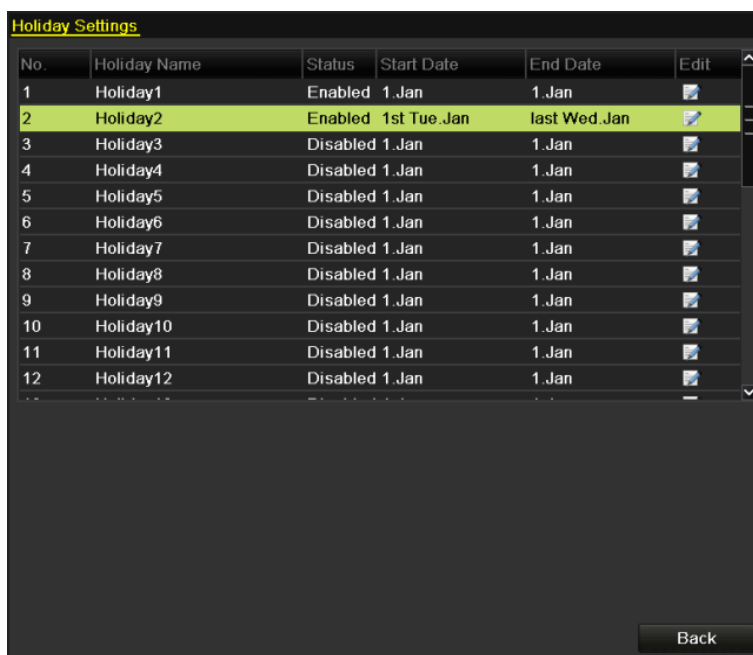

Figure 5. 22 Holiday Settings

2. Enable Edit Holiday schedule.

1) Click to enter the Edit interface.

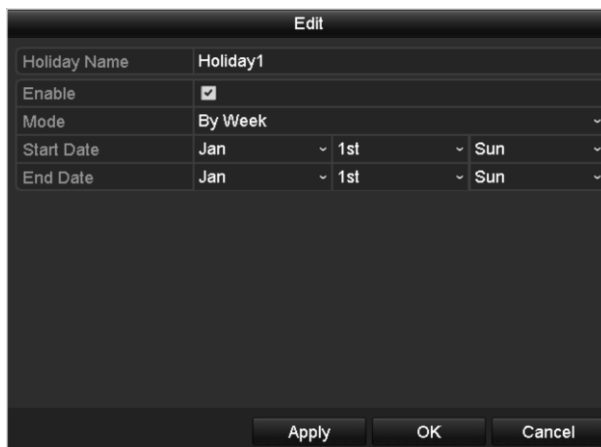

Figure 5. 23 Edit Holiday Settings

- 2) Check the checkbox after **Enable Holiday**.
 - 3) Select Mode from the dropdown list.
There are three different modes for the date format to configure holiday schedule.
 - 4) Set the start and end date.
 - 5) Click **Apply** to save settings.
 - 6) Click **OK** to exit the Edit interface.
3. Enter Record/Capture Schedule settings interface to edit the holiday recording schedule. See *Chapter 6.2 Configuring Recording/Capture Schedule*.

5.7 Configuring Redundant Recording and Capture

Purpose:

Enabling redundant recording and capture, which means saving the record files and captured pictures not only in the R/W HDD but also in the redundant HDD, will effectively enhance the data safety and reliability. .

Steps:

1. Enter HDD Information interface.

Menu> HDD

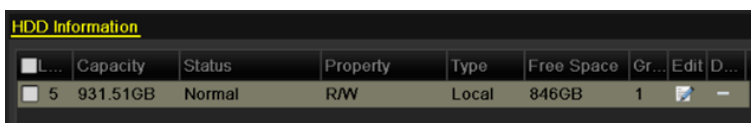

Figure 5. 24 HDD General

2. Select the **HDD** and click to enter the Local HDD Settings interface.

- 1) Set the HDD property to Redundancy.



Figure 5. 25 HDD General-Editing

- 2) Click **Apply** to save the settings.
- 3) Click **OK** to back to the upper level menu.



You must set the Storage mode in the HDD advanced settings to Group before you set the HDD property to Redundant. For detailed information, please refer to *Chapter 11.4.1 Setting HDD Property*. There should be at least another HDD which is in Read/Write status.

3. Enter the Record setting interface.

Menu> Record> Parameters

- 1) Select **Record** tab.

Camera	IP Camera 1	
Encoding Parameters	Main Stream(Continuous)	Main Stream(Event)
Stream Type	Video & Audio	Video & Audio
Resolution	704*576(4CIF)	704*576(4CIF)
Bitrate Type	Variable	Variable
Video Quality	Medium	Medium
Frame Rate	Full Frame	Full Frame
Max. Bitrate Mode	General	General
Max. Bitrate(Kbps)	2048	2048
Max. Bitrate Range Reco...	1152~1920(Kbps)	1152~1920(Kbps)
Pre-record	5s	
Post-record	5s	
Expired Time (day)	0	
Redundant Record/Capt...	<input type="checkbox"/>	
Record Audio	<input checked="" type="checkbox"/>	
Video Stream	Main Stream	

Figure 5. 26 Record Parameters

- 2) Select Camera you want to configure in the drop-down list.
- 3) Check the **checkbox** of **Redundant Record/Capture**.
- 4) Click **OK** to save settings and back to the upper level menu.

Repeat the above steps for configuring other channels.

5.8 Configuring HDD Group for Recording and Capture

Purpose:

You can group the HDDs and save the record files and captured pictures in certain HDD group.

Steps:

1. Enter HDD setting interface.

Menu>HDD

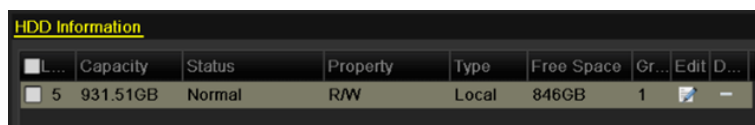

Figure 5.27 HDD General

2. Select **Advanced** on the left side menu.



Figure 5.28 Storage Mode

Check whether the storage mode of the HDD is Group. If not, set it to Group. For detailed information, please refer to *Chapter 11.4 Managing HDD Group*.

3. Select **General** in the left side menu
4. Click to enter editing interface.
5. Configuring HDD group.
 - 1) Choose a group number for the HDD group.
 - 2) Click **Apply** and then in the pop-up message box, click **Yes** to save your settings.
 - 3) Click **OK** to back to the upper level menu.

Repeat the above steps to configure more HDD groups.

6. Choose the Channels which you want to save the record files and captured pictures in the HDD group.
 - 1) Select **Advanced** on the left bar.
 - 2) Choose Group number in the dropdown list of **Record on HDD Group**
 - 3) Check the channels you want to save in this group.
 - 4) Click **Apply** to save settings.



After having configured the HDD groups, you can configure the Recording and Capture settings following the procedure provided in *Chapter 5.2-5.7*.

5.9 Files Protection

Purpose:

You can lock the recording files or set the HDD property to Read-only to protect the record files from being overwritten.

5.9.1 Locking the Recording Files

Lock File when Playback

Steps:

1. Enter Playback interface.
Menu> Playback
2. Check the checkbox of channel(s) in the channel list and then double-click to select a date on the calendar.



Figure 5. 29 Normal Playback

3. During playback, click the  button to lock the current recording file.



In the multi-channel playback mode, clicking the  button will lock all the record files related to the playback channels.



4. You can click the  button to pop up the file management interface. Click the **Locked File** tab to check and export the locked files.



Figure 5. 30 Locked File Management

In the File Management interface, you can also click  to change it to  to unlock the file and the file is not protected.

● **Lock File when Export**

Steps:

1. Enter Export setting interface.
Menu> Export

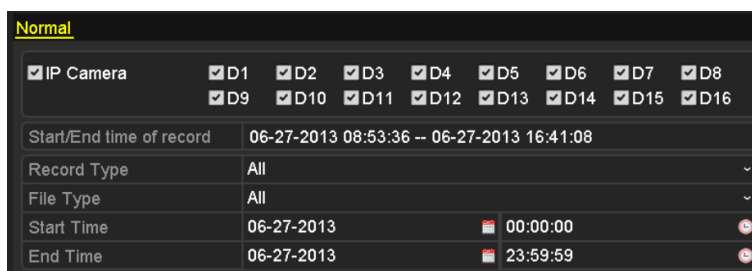

Figure 5. 31 Export



2. Select the channels you want to investigate by checking the checkbox to .
3. Configure the record type, file type start/end time.
4. Click **Search** to show the results.



Figure 5. 32 Export- Search Result

5. Protect the record files.

- 1) Find the record files you want to protect, and then click the  icon which will turn to , indicating that the file is locked.



The record files of which the recording is still not completed cannot be locked.



- 2) Click  to change it to  to unlock the file and the file is not protected.



Figure 5.33 Unlocking Attention

5.9.2 Setting HDD Property to Read-only

Steps:

1. Enter HDD setting interface.

Menu> HDD

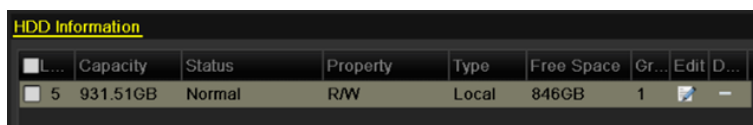

Figure 5.34 HDD General

2. Click  to edit the HDD you want to protect.

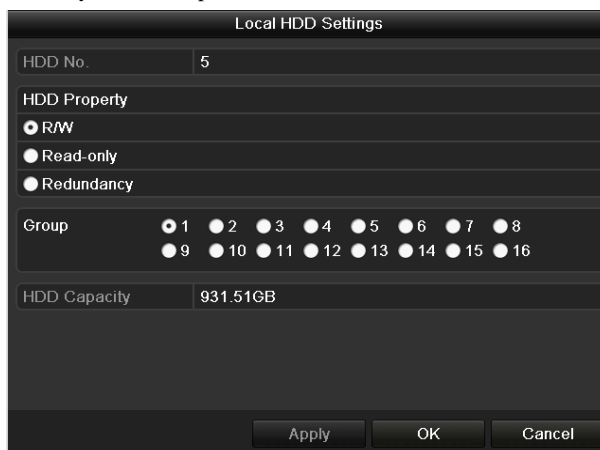

Figure 5.35 HDD General- Editing



To edit HDD property, you need to set the storage mode of the HDD to Group. See *Chapter Managing HDD Group*.

3. Set the HDD property to Read-only.
4. Click **OK** to save settings and back to the upper level menu.



- You cannot save any files in a Read-only HDD. If you want to save files in the HDD, change the property to R/W.
- If there is only one HDD and is set to Read-only, the NVR can't record any files. Only live view mode is available.
- If you set the HDD to Read-only when the NVR is saving files in it, then the file will be saved in next R/W HDD. If there is only one HDD, the recording will be stopped.

Chapter 6 Playback

6.1 Playing Back Record Files

6.1.1 Playing Back by Channel

Purpose:

Play back the recorded video files of a specific channel in the live view mode. Channel switch is supported.

Instant playback by channel

Steps:

Choose a channel in live view mode using the mouse and click the  button in the quick setting toolbar.



In the instant playback mode, only record files recorded during the last five minutes on this channel will be played back.



Figure 6. 1 Instant Playback Interface

Playback by channel

1. Enter the Playback interface.

Mouse: right click a channel in live view mode and select Playback from the menu, as shown in Figure 6. 2.

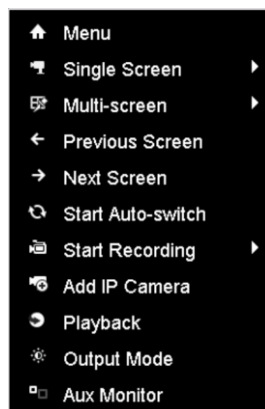

Figure 6.2 Right-click Menu under Live View

Front Panel: press **PLAY** button to play back record files of the channel under single-screen live view mode.



Pressing numerical buttons will switch playback to the corresponding channels during playback process.

2. Playback management.

The toolbar in the bottom part of Playback interface can be used to control playing progress, as shown in Figure 6.3.



Figure 6.3 Playback Interface

Click the channel(s) to execute simultaneous playback of multiple channels.



Figure 6.4 Toolbar of Playback



- The **06-27-2013 08:58:59 -- 06-27-2013 09:44:02** indicates the start/end time of the record.
- About video type bar: **■** represents normal recording (manual or schedule); **■** represents event recording (motion, alarm, motion | alarm, motion & alarm, VCA).
- Playback progress bar: use the mouse to click any point of the progress bar to locate special frames, and drag the cursor to show the thumbnail of the current time.

Table 6. 1 Detailed Explanation of Playback Toolbar

Button	Operation	Button	Operation	Button	Operation	Button	Operation
	Audio on/ Mute		Adjust volume		Start/Stop clipping		Capture
	File lock		Add default tag		Add customized tag		File Management
	Digital Zoom		Pause reverse play/ Reverse play/ Single-frame reverse play		Stop		Pause play/ Play/ Single-frame play
	30s forward		30s reverse		Speed down		Speed up
	Previous day		Next day		Scaling up/down the time line		Process bar
	Video type bar		Playback type / picture		Full screen		Exit

6.1.2 Playing Back by Time

Purpose:

Play back video files recorded in specified time duration. Multi-channel simultaneous playback and channel switch are supported.

Steps:

1. Enter playback interface.
Menu>Playback
2. Check the checkbox of channel(s) in the channel list and then double-click to select a date on the calendar.



Figure 6. 5 Playback Calendar



If there are record files for that camera in that day, in the calendar, the icon for that day is displayed as **10**.
 Otherwise it is displayed as **10**.

In the Playback interface:

The toolbar in the bottom part of Playback interface can be used to control playing process, as shown in Figure 6.6.



Figure 6.6 Interface of Playback by Time



Figure 6.7 Toolbar of Playback by Time



- The **06-27-2013 08:58:59 -- 06-27-2013 09:44:02** indicates the start/end time of the record.
- About video type bar: **■** represents normal recording (manual or schedule); **■** represents event recording (motion, alarm, motion | alarm, motion & alarm, VCA).
- Playback progress bar: use the mouse to click any point of the progress bar to locate special frames, and drag the cursor to show the thumbnail of the current time.

Table 6.2 Detailed Explanation of Playback-by-time Interface

Button	Operation	Button	Operation	Button	Operation	Button	Operation
	Audio on/ Mute		Adjust volume		Start/Stop clipping		Capture
	File lock		Add default tag		Add customized tag		File Management
	Digital Zoom		Pause reverse play/ Reverse play/		Stop		Pause play/ Play/ Single-frame

Button	Operation	Button	Operation	Button	Operation	Button	Operation
			Single-frame reverse play				play
	30s forward		30s reverse		Speed down		Speed up
	Previous day		Next day		Scaling up/down the time line		Process bar
	Video type bar		Playback type / picture		Full screen		Exit

6.1.3 Playing Back by Event Search

Purpose:

Play back record files on one or several channels searched out by restricting event type (e.g. alarm input and motion detection).

Before you start:

To get the motion and VCA search result, the corresponding type must be enabled and configured for the IP camera.

Steps:

1. Enter the Playback interface.
Menu>Playback
2. Select the **Event** in the drop-down list on the top-left side.
3. Select **Alarm Input**, **Motion** or **VCA** as the event type, edit the Start time and End time.



Here we take playback by motion as the example.

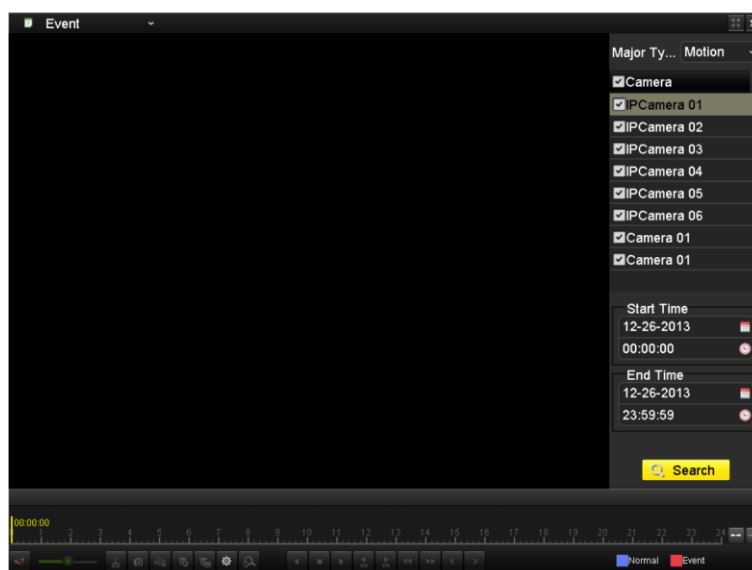

Figure 6. 8 Motion Search Interface

- Click **Search** button to get the search result information. You may refer to the right-side bar for the result.

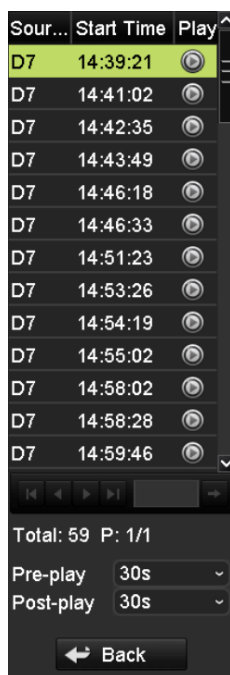



Figure 6.9 Search Result Bar(Motion)

- Click  button to play back the file.
 You can click the **Back** button to back to the search interface.



Pre-play and post-play can be configured.

- Playback interface.

The toolbar in the bottom part of Playback interface can be used to control playing process.



Figure 6.10 Interface of Playback by Event



Figure 6. 11 Toolbar of Playback by Event



- The 06-27-2013 08:58:59 -- 06-27-2013 09:44:02 indicates the start/end time of the record.
- About video type bar: ■ represents normal recording (manual or schedule); ■ represents event recording (motion, alarm, motion | alarm, motion & alarm, VCA).
- Playback progress bar: use the mouse to click any point of the progress bar to locate special frames.

Table 6. 3 Detailed Explanation of Playback-by-event Toolbar

Button	Operation	Button	Operation	Button	Operation	Button	Operation
	Audio on/ Mute		Adjust volume		Start/Stop clipping		Capture
	File lock		Add default tag		Add customized tag		File Management
	Digital Zoom		Pause reverse play/ Reverse play/ Single-frame reverse play		Stop		Pause play/ Play/ Single-frame play
	30s forward		30s reverse		Speed down		Speed up
	Previous day		Next day		Scaling up/down the time line		Process bar
	Video type bar		Playback type / picture		Full screen		Exit

6.1.4 Playing Back by Tag

Purpose:

Video tag allows you to record related information like people and location of a certain time point during playback. You are also allowed to use video tag(s) to search for record files and position time point.

Before playing back by tag:

1. Enter Playback interface.
Menu>Playback
2. Search and play back the record file(s). Refer to *Chapter 6.1.1* for the detailed information about searching and playback of the record files.



Figure 6.12 Interface of Playback by Time

Click button to add default tag.

Click button to add customized tag and input tag name.



Max. 64 tags can be added to a single video file.

3. Tag management.

- 1) Click button to enter the file management interface.
- 2) Click the **Tag** tab, and you can check, edit and delete tag(s).



Figure 6.13 Tag Management Interface

Steps:

1. Select the **Tag** from the drop-down list in the Playback interface.
2. Choose channels, edit start time and end time, and then click **Search** to enter Search Result interface.



You can enter keyword in the textbox to search the tag on your demand.

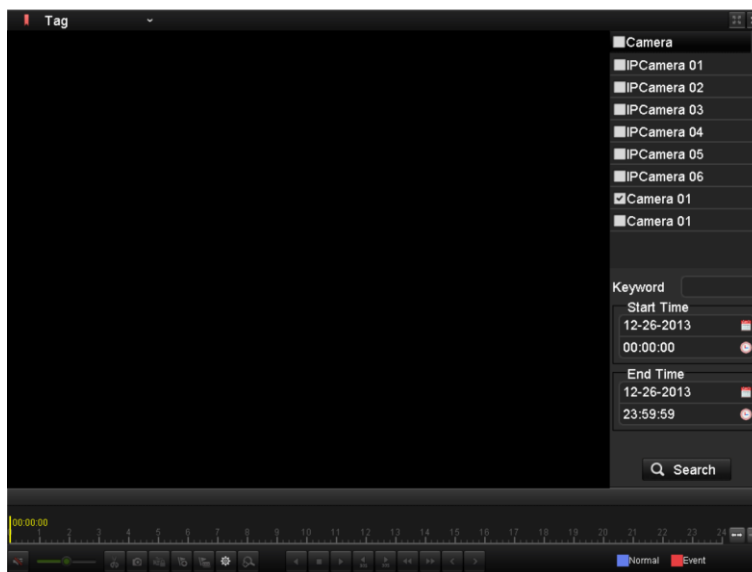



Figure 6. 14 Video Search by Tag

3. Click  button to play back the file.
You can click the **Back** button to back to the search interface.



Pre-play and post-play can be configured.



Figure 6. 15 Interface of Playback by Tag



Figure 6. 16 Toolbar of Playback by Tag



- The 06-27-2013 08:58:59 -- 06-27-2013 09:44:02 indicates the start/end time of the record.
- About video type bar: ■ represents normal recording (manual or schedule); ■ represents event recording (motion, alarm, motion | alarm, motion & alarm, VCA).
- Playback progress bar: use the mouse to click any point of the progress bar to locate special frames.

Table 6. 4 Detailed Explanation of Playback-by-tag Toolbar

Button	Operation	Button	Operation	Button	Operation	Button	Operation
	Audio on/ Mute		Adjust volume		Start/Stop clipping		Capture
	File lock		Add default tag		Add customized tag		File Management
	Digital Zoom		Pause reverse play/ Reverse play/ Single-frame reverse play		Stop		Pause play/ Play/ Single-frame play
	30s forward		30s reverse		Speed down		Speed up
	Previous day		Next day		Scaling up/down the time line		Process bar
	Video type bar		Playback type / picture		Full screen		Exit

6.1.5 Smart Playback

Purpose:

The smart playback function provides an easy way to get through the less effective information. When you select the smart playback mode, the system will analyze the video containing the motion or VCA information, mark it with green color. And the recording file filtering rule and playback speed for the non-related and related video can be configured on your demand.

Steps:

1. Enter Playback interface.
Menu>Playback
2. Select the **Smart** in the drop-down list on the top-left side.
3. Select a camera in the camera list and select a date in the calendar and click the button to play.
4. Click the on the playback control toolbar to enter configure the Smart Search rule.

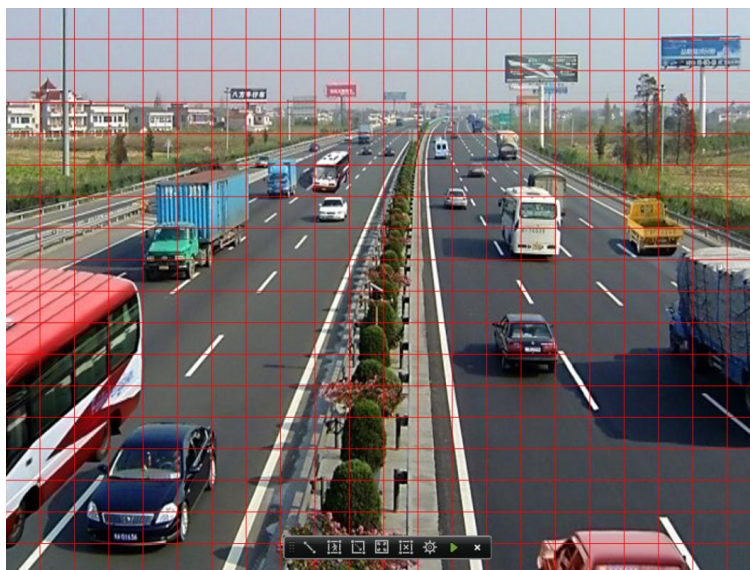



Figure 6.17 Draw Area of Smart Search

5. Set the smart search rules.

Traversing Virtual Plane Detection

Click the  button, and click on the screen to specify the beginning point and move the mouse to the end of the plane and click again.



Intrusion Detection

Click the  button, and then specify 4 points to set a quadrilateral region for intrusion detection.



Only one region can be set.

Motion Detection

- 1) Click the  to set the search area manually, or click the  button to set the full screen as the area.
- 2) Click and drag the mouse to draw target searching area(s).

6. Click the  button to set the playback settings.

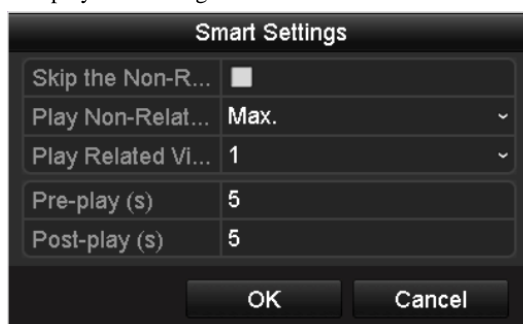

Skip the Non-Related Video: The non-related video will not be played after this function is enabled, as well as the set value of play non-related video will be invalid.

Play Non-Related Video at: Set the speed to play the non-related video, there are Max./8/4/1 selectable.

Play Related Video at: Set the speed to play the related video, there are Max./8/4/1 selectable.



Pre-play and post-play can be configured for the Intrusion Detection type.





7. Click the  to search, and then the result will be displayed as  in the progress bar of the Smart Playback interface.
Or you can click the  button to clear all the set areas.
8. Click the  button to play.



Figure 6. 18 Smart Playback Interface











- The **06-27-2013 08:58:59 -- 06-27-2013 09:44:02** indicates the start/end time of the record.
- About video type bar:  represents normal recording (manual or schedule);  represents event recording (motion, alarm, motion | alarm, motion & alarm, VCA); and  represents the smart search result.
- Playback progress bar: use the mouse to click any point of the progress bar to locate special frames.

Table 6. 5 Detailed Explanation of Smart Playback

Button	Operation	Button	Operation	Button	Operation
	Smart search		Stop		Pause play / Play
	Process bar		Scaling up/down the time line		Playback type / Picture

6.1.6 Playing Back by System Logs

Purpose:

Play back record file(s) associated with channels after searching system logs.

Steps:

1. Enter Log Information interface.
Menu>Maintenance>Log Information
2. Click **Log Search** tab to enter Playback by System Logs.
Set search time and type and click **Search** button.

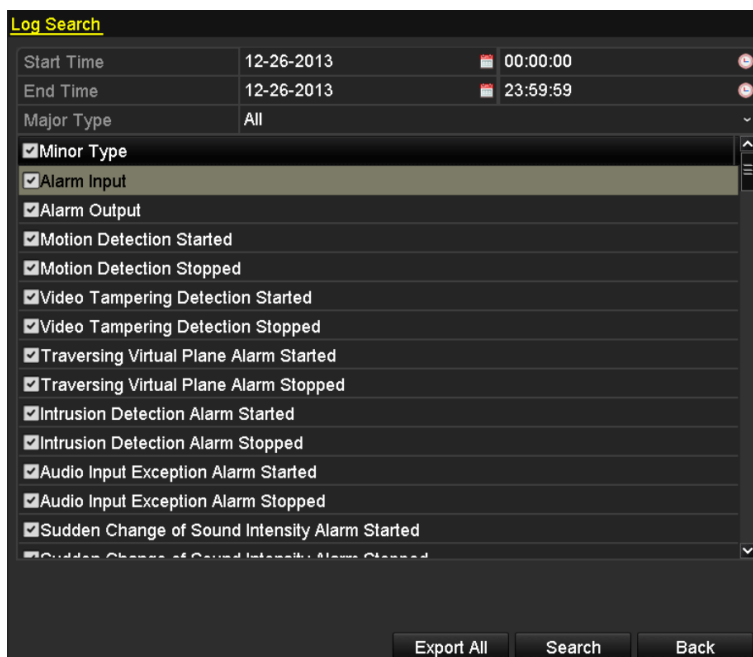

Figure 6. 19 System Log Search Interface

3. Choose a log with record file and click  button to enter Playback interface.



If there is no record file at the time point of the log, the message box “No result found” will pop up.

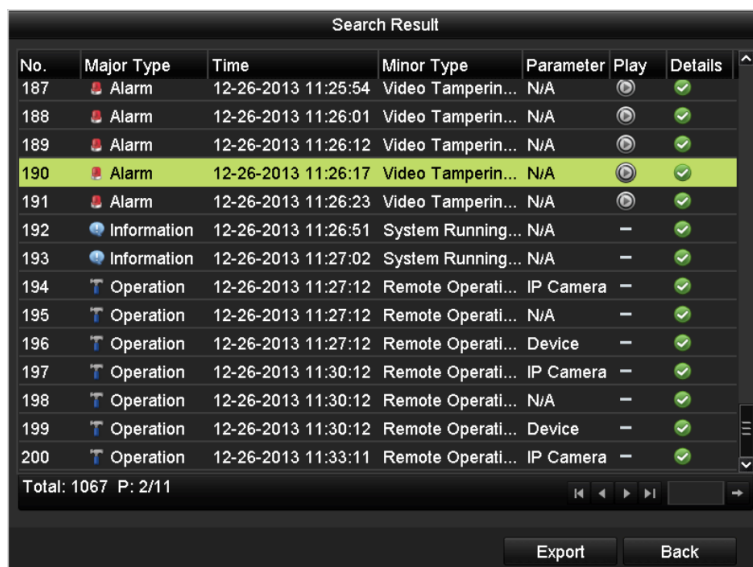

Figure 6. 20 Result of System Log Search

4. Playback interface.

The toolbar in the bottom part of Playback interface can be used to control playing process.



Figure 6. 21 Interface of Playback by Log

6.1.7 Playing Back External File

Purpose:

Perform the following steps to look up and play back files in the external devices.

Steps:





1. Enter Playback interface.
Menu>Playback
2. Select the **External File** in the drop-down list on the top-left side.
The files are listed in the right-side list.
You can click the  Refresh button to refresh the file list.
3. Select and click the  button to play back it. And you can adjust the playback speed by clicking  and .

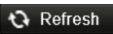

Figure 6. 22 Interface of External File Playback

6.2 Auxiliary Functions of Playback

6.2.1 Playing Back Frame by Frame

Purpose:



Play video files frame by frame, in case of checking image details of the video when abnormal events happen.

Steps:



- **Using a Mouse:**

Go to Playback interface.

If you choose playback of the record file: click button  until the speed changes to Single frame and one click on the playback screen represents playback of one frame.

If you choose reverse playback of the record file: click button  until the speed changes to Single frame and one click on the playback screen represents reverse playback of one frame. It is also feasible to use button  in toolbar.

- **Using the Front Panel:**

Rotate and hold the outer ring on Jog Shuttle counter clockwise (for DS-7700/8600NI-ST only) or click the  button to set the speed to Single frame. One click on  button, one click on the playback screen or Enter button on the front panel represents playback or reverse playback of one frame.

6.2.2 Digital Zoom

Steps:

1. Click the  button on the playback control bar to enter Digital Zoom interface.
2. Use the mouse to draw a red rectangle and the image within it will be enlarged up to 16 times.



Figure 6.23 Draw Area for Digital Zoom

3. Right-click the image to exit the digital zoom interface.

6.2.3 Reverse Playback of Multi-channel

Purpose:

You can play back record files of multi-channel reversely. Up to 16-ch (with 1280*720 resolution) simultaneous reverse playback is supported; up to 4-ch (with 1920*1080P resolution) simultaneous reverse playback is supported and up to 1-ch (with 2560*1920 resolution) reverse playback is supported.



We use the interface of DS-7700NI-ST series (unless stated) as example to describe the following settings.

Steps:

1. Enter Playback interface.
Menu>Playback
2. Check more than one checkboxes to select multiple channels and click to select a date on the calendar.



Figure 6. 24 4-ch Synchronous Playback Interface



The record files will be marked by two lines on the process bar. The upper one indicates the record files of the selected channel; and the lower one indicates the record files of all the selected channels.

3. Click  to play back the record files reversely.

6.3 Picture Playback

Purpose:

Search and view captured pictures stored in HDD.

Steps:

1. Enter Playback interface.
Menu>Playback
2. Select the **Picture** in the drop-down list on the top-left side.

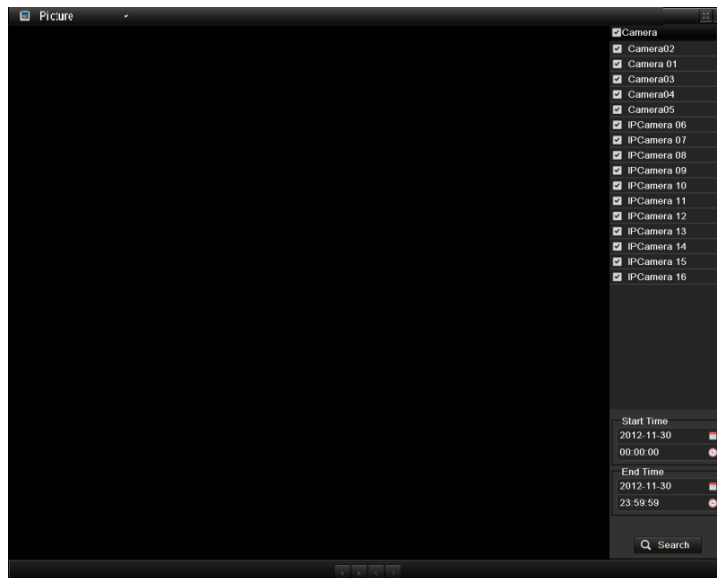

Figure 6.25 Interface of Playback by Picture

3. Choose channels, edit start time and end time, and then click **Search** to show searching result.
4. Choose a picture you want to view and click  button.
You can click the **Back** button to back to the search interface.







Figure 6.26 Result of Picture Search

5. The toolbar in the bottom part of Playback interface can be used to control playing process.



Figure 6. 27 Picture Playback Toolbar

Table 6. 6 Detailed Explanation of Picture-playback Toolbar

Button	Function	Button	Function	Button	Function	Button	Function
	Play reverse		Play		Previous picture		Next picture

Chapter 7 Backup

7.1 Backing up Record Files

7.1.1 Quick Export

Purpose:

Export record files to backup device(s) quickly.

Steps:

1. Enter Video Export interface.

Menu>Export>Normal

Choose the channel(s) you want to back up and click **Quick Export** button.



The time duration of record files on a specified channel cannot exceed one day. Otherwise, the message box “Max. 24 hours are allowed for quick export.” will pop up.

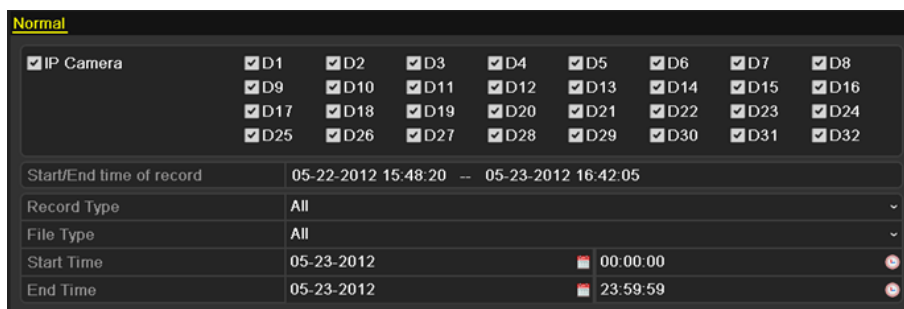

Figure 7.1 Quick Export Interface

2. Click on the **Export** button to start exporting.



Here we use USB Flash Drive and please refer to the next section Normal Backup for more backup devices supported by the NVR.

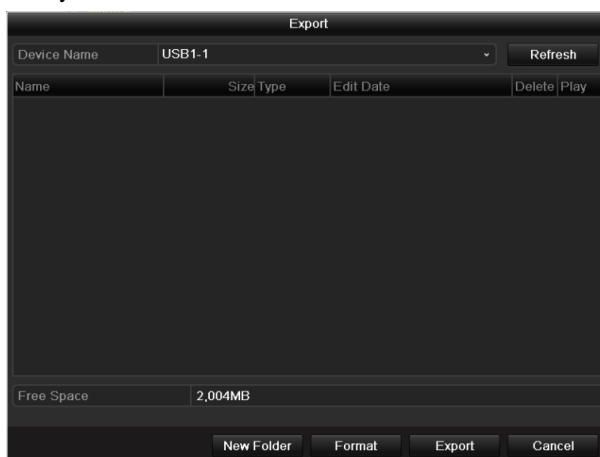

Figure 7.2 Quick Export using USB1-1

Stay in the Exporting interface until all record files are exported.

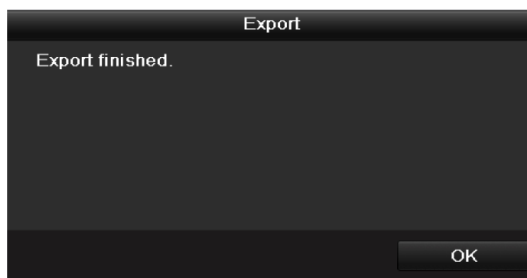

Figure 7.3 Export Finished

3. Check backup result.

Choose the record file in Export interface and click button  to check it.



The Player player.exe will be exported automatically during record file export.

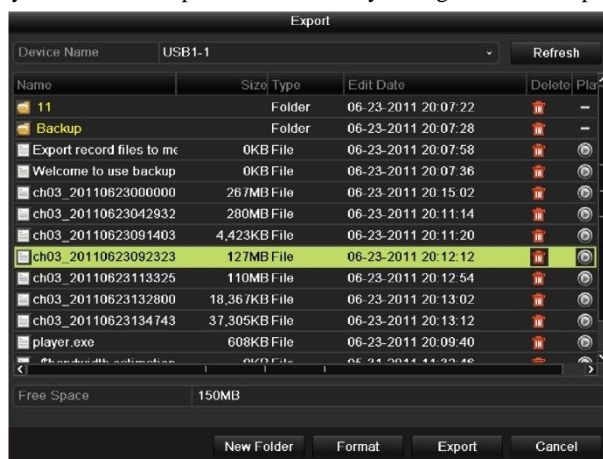

Figure 7.4 Checkup of Quick Export Result Using USB1-1

7.1.2 Backing up by Normal Video Search

Purpose:

The record files can be backup to various devices, such as USB devices (USB flash drives, USB HDDs, USB writer), SATA writer and e-SATA HDD.

Backup using USB flash drives and USB HDDs

Steps:

1. Enter Export interface.
Menu>Export>Normal
2. Set search condition and click **Search** button to enter the search result interface.

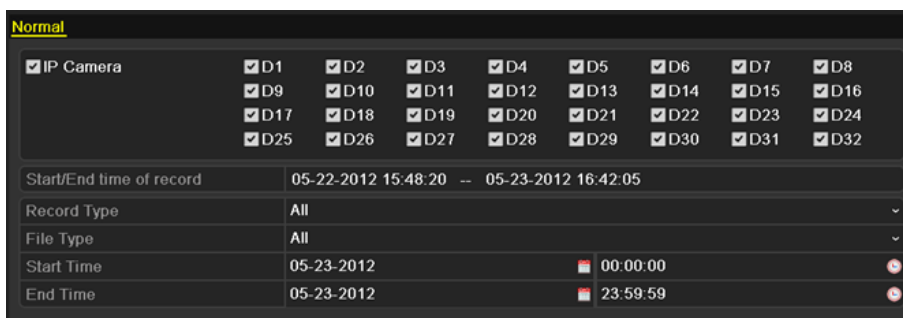



Figure 7.5 Normal Video Search for Backup

3. Select record files you want to back up.

Click  to play the record file if you want to check it.

Check the checkbox before the record files you want to back up.



The size of the currently selected files is displayed in the lower-left corner of the window.

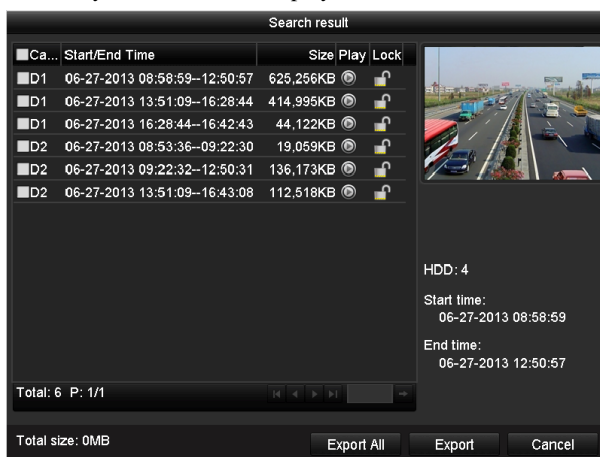

Figure 7.6 Result of Normal Video Search for Backup

4. Export.

Click **Export All** button to export all the recording files.

Or you can select recording files you want to back up, and click **Export** button to enter Export interface.



If the inserted USB device is not recognized:

- Click the **Refresh** button.
- Reconnect device.
- Check for compatibility from vendor.

You can also format USB flash drives or USB HDDs via the device.

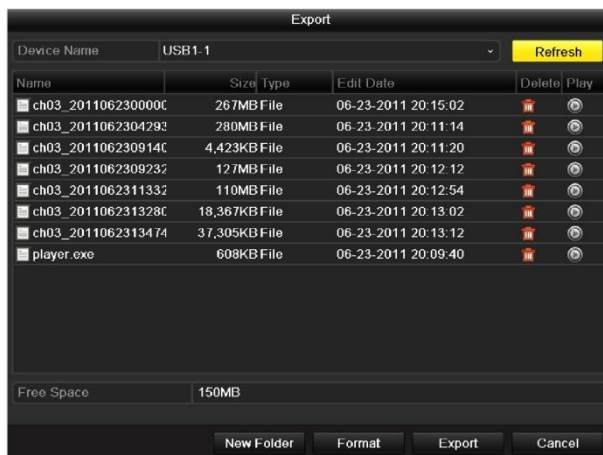

Figure 7.7 Export by Normal Video Search using USB Flash Drive

Stay in the Exporting interface until all record files are exported with pop-up message box “Export finished”.

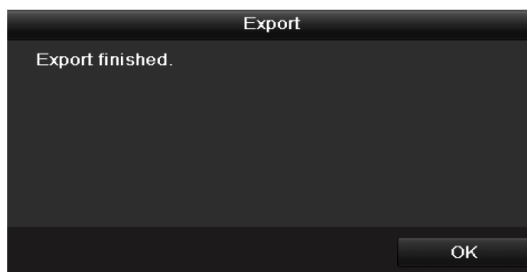



Figure 7.8 Export Finished

5. Check backup result.

Choose the record file in Export interface and click button  to check it.



The Player player.exe will be exported automatically during record file export.

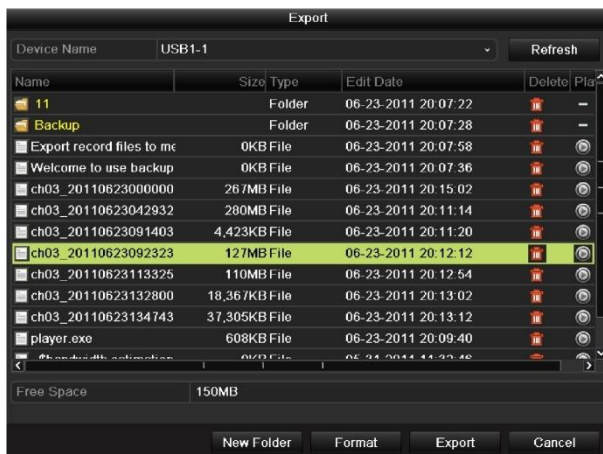

Figure 7.9 Checkup of Export Result using USB Flash Drive

Backup using USB writer and SATA writer

Steps:

1. Enter Export interface.

Menu>Export>Normal

2. Set search condition and click **Search** button to enter the search result interface.

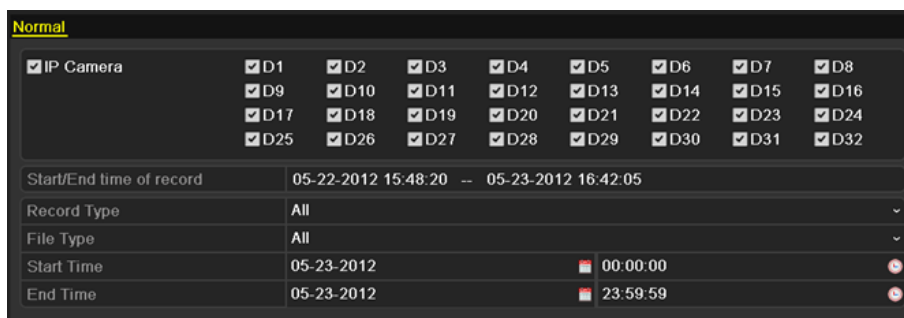



Figure 7.10 Normal Video Search for Backup

3. Select record files you want to back up.

Click button  to play the record file if you want to check it.

Check the checkbox before the record files you want to back up.



The size of the currently selected files is displayed in the lower-left corner of the window.

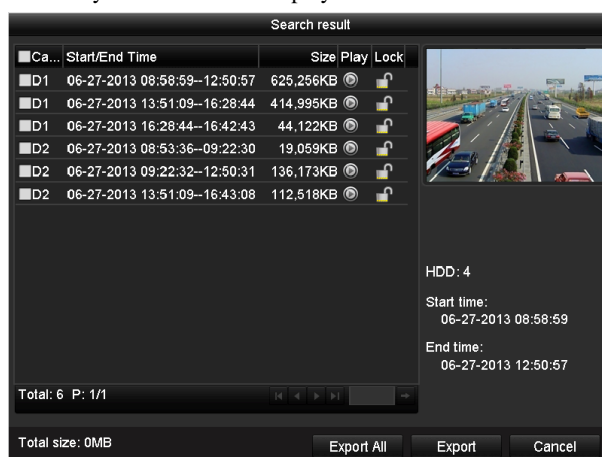

Figure 7.11 Result of Normal Video Search for Backup

4. Export.

Click **Export** button and start backup.



If the inserted USB writer or SATA writer is not recognized:

- Click the **Refresh** button.
- Reconnect device.
- Check for compatibility from vendor.



Figure 7.12 Export by Normal Video Search using USB Writer

Stay in the Exporting interface until all record files are exported with pop-up message box “Export finished”.

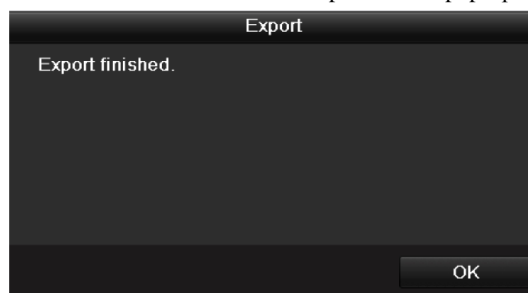

Figure 7.13 Export Finished

5. Check backup result.

Choose the record file in Export interface and click button  to check it.



The Player player.exe will be exported automatically during record file export.

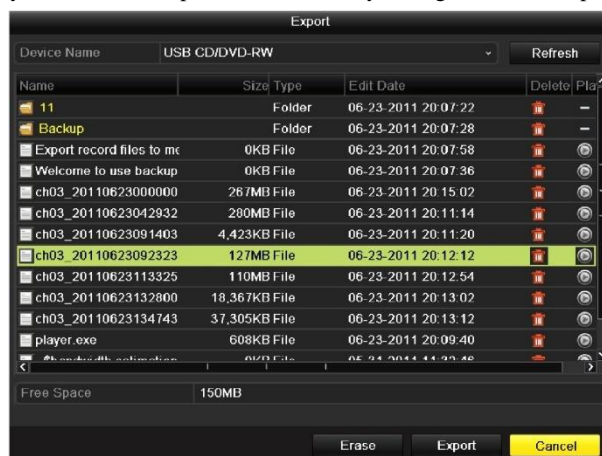

Figure 7.14 Checkup of Export Result using USB Writer

Backup using eSATA HDDs

Steps:

1. Enter Record>Advanced and set the usage of eSATA HDD at “Export”.

Menu>Record>Advanced

Choose eSATA and set its usage at Export. Click **Yes** when pop-up message box “System will reboot automatically if the usage of eSATA is changed. Continue?”



The usages of eSATA HDD contain Record/Capture and Export. And changes in usage will take effective after rebooting the device.

2. Enter Export interface.

Menu>Export>Normal

Set search condition and click **Search** button to enter the search result interface.

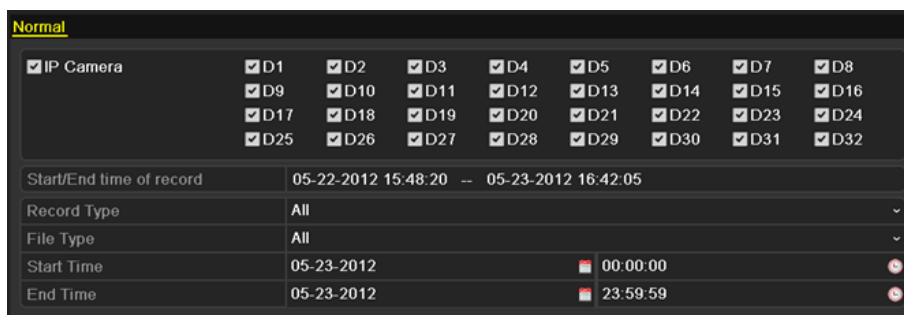

Figure 7. 15 Normal Video Search for Backup

3. Select record files you want to back up.

Click button to play the record file if you want to check it.

Tick record files you want to back up.



The size of the currently selected files is displayed in the lower-left corner of the window.

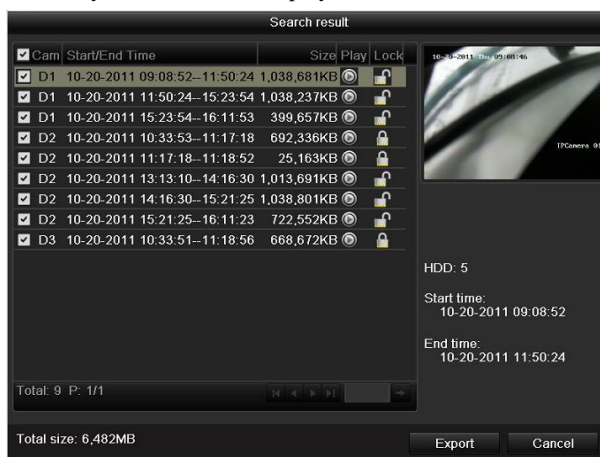

Figure 7. 16 Result of Normal Video Search for Backup

4. Export.

Click **Export All** button to export all the recording files.

Or you can select recording files you want to back up, and click **Export** button to enter Export interface.



Please format the eSATA first when using it for the first time. If the inserted eSATA HDD is not recognized:

- Click the **Refresh** button.
- Reconnect device.
- Check for compatibility from vendor.

You can also format SATA HDD via the device.



Figure 7. 17 Export by Normal Video Search Using eSATA HDD

Stay in the Exporting interface until all record files are exported with pop-up message “Export finished”.

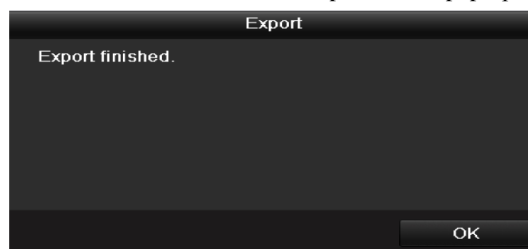



Figure 7. 18 Export Finished

5. Check backup result.

Choose the record file in Export interface and click button  to check it.



The Player player.exe will be exported automatically during record file export.

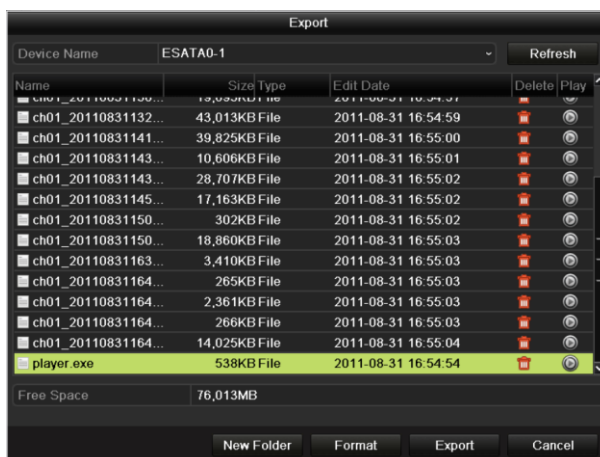

Figure 7. 19 Checkup of Export Result Using eSATA HDD

7.1.3 Backing up by Event Search

Purpose:

Back up event-related record files using USB devices (USB flash drives, USB HDDs, USB writer), SATA writer or eSATA HDD. Quick Backup and Normal Backup are supported.

Steps:

1. Enter Export interface.
Menu>Export>Event
 - 1) Select “Alarm Input” from the dropdown list of Event Type.
 - 2) Select the alarm input No. and time.
 - 3) Click **Search** button to enter the Search Result interface.



Event types contain Alarm Input, Motion and VCA; we take export by alarm input as an example.

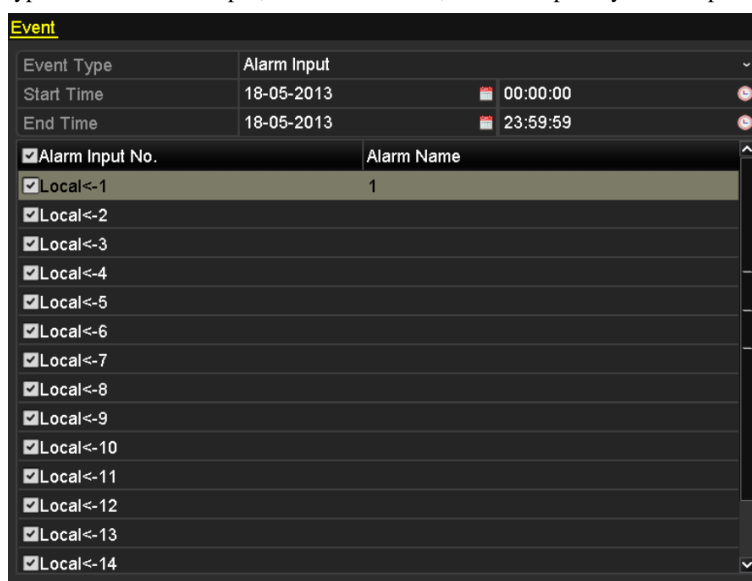

Figure 7. 20 Event Search for Backup

2. Select record files to export.

- 1) Clicking **Quick Export** button will export record files of all channels triggered by the selected alarm input.

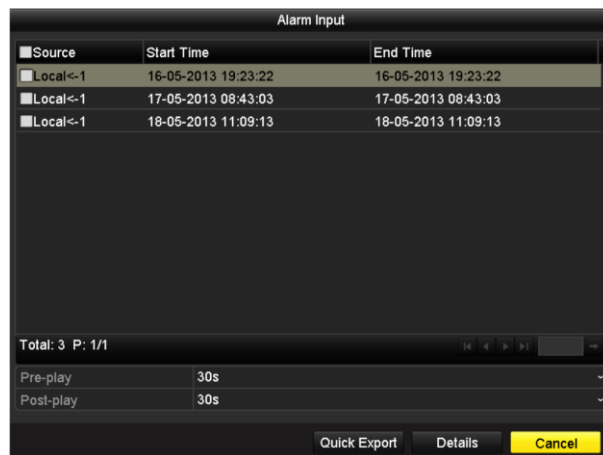

Figure 7. 21 Result of Event Search

- 2) Click **Details** button to view detailed information of the record file, e.g. start time, end time, file size, etc.



Figure 7. 22 Event Details Interface

3. Export.

Click **Export All** button to export all the recording files.

Or you can select recording files you want to back up, and click **Export** button to enter Export interface.



If the inserted USB device is not recognized:

- Click the Refresh button.
- Reconnect device.
- Check for compatibility from vendor.

You can also format USB flash drive or USB HDDs via the device.

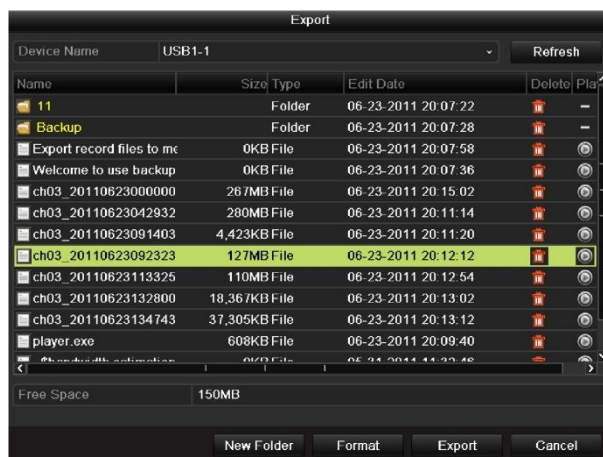

Figure 7.23 Export by Event Using USB Flash Drive

Stay in the Exporting interface until all record files are exported with pop-up message “Export finished”.

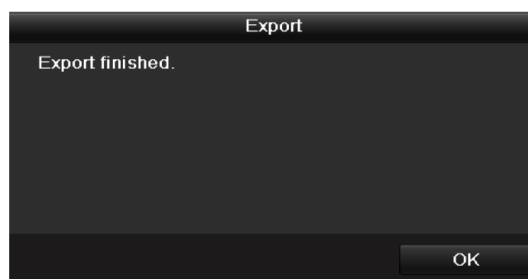

Figure 7.24 Export Finished

4. Check backup result.





The Player player.exe will be exported automatically during record file export.

7.1.4 Backing up Video Clips

Purpose:

You may also select video clips to export directly during Playback, using USB devices (USB flash drives, USB HDDs, USB writer), SATA writer or eSATA HDD.

Steps:

1. Enter Playback interface.
Please refer to *Chapter 6.1 Playing Back Record Files*.
2. During playback, use buttons  and  in the playback toolbar to start or stop clipping recording file(s).
3. Click the  button to pop up the file management interface. Click the **Video Clips** tab to check and export the files.

Or the prompt of saving files will pop up when you quit the playback interface.



A maximum of 30 clips can be selected for each channel.

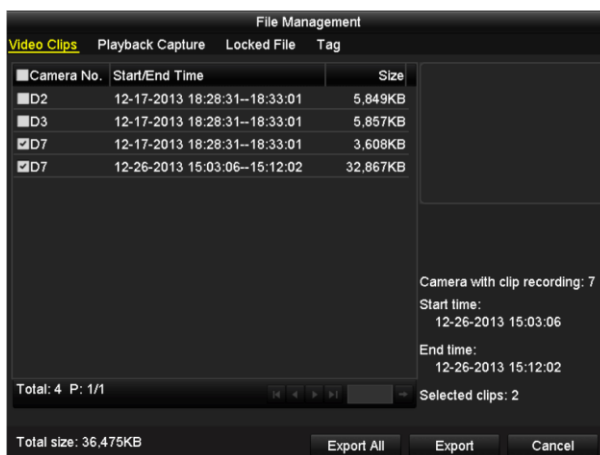

Figure 7. 25 Clips Export Interface

4. Check the checkbox of files and click **Export** button and start backup.
 Or the click the **Export All** button to export all the files.



If the inserted USB device is not recognized:

- Click the **Refresh** button.
- Reconnect device.
- Check for compatibility from vendor.

You can also format USB flash drive or USB HDDs via the device.

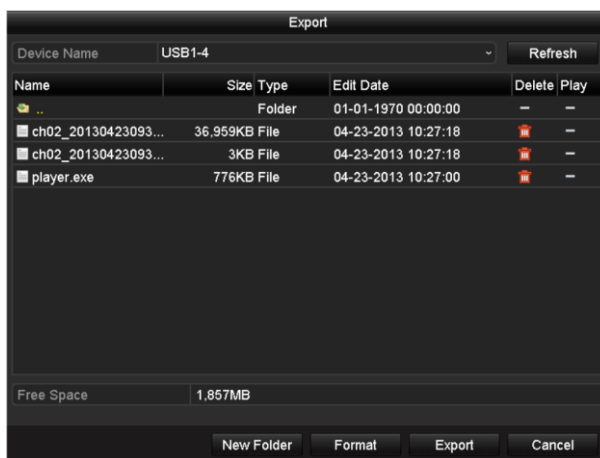

Figure 7. 26 Export Using USB Flash Drive

Stay in the Exporting interface until all record files are exported with pop-up message “Export finished”.

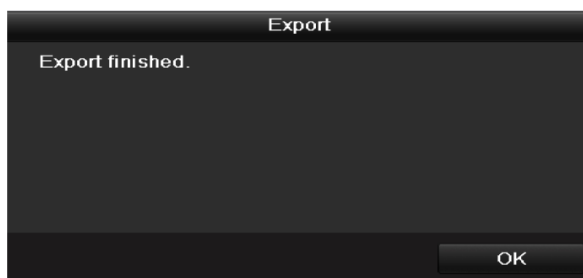

Figure 7. 27 Export Finished

5. Check backup result.





The Player player.exe will be exported automatically during record file export.

7.2 Backing up Pictures

● Backing up Captured Pictures When Playback

Steps:

1. Enter Playback interface.
Please refer to *Chapter 6.1 Playing Back Record Files*.
2. During playback, click the  button to capture picture.
3. You can click the  button to pop up the file management interface. Click the **Playback Capture** tab to check and export the pictures.

Or the prompt of saving pictures will pop up when you quit the playback interface.



Figure 7.28 Captured Pictures Export Interface

4. Repeat the steps 4-5 of Chapter 7.1.4 to export the files.

● Backing up All Types of Captured Pictures

Purpose:

Back up pictures using USB devices (USB flash drives, USB HDDs, USB writer), SATA writer or eSATA HDD.

Steps:

1. Enter Export interface.
Menu>Export>Picture
Select channel(s), image type, start time and end time, and click **Search** button to enter the Search Result interface.

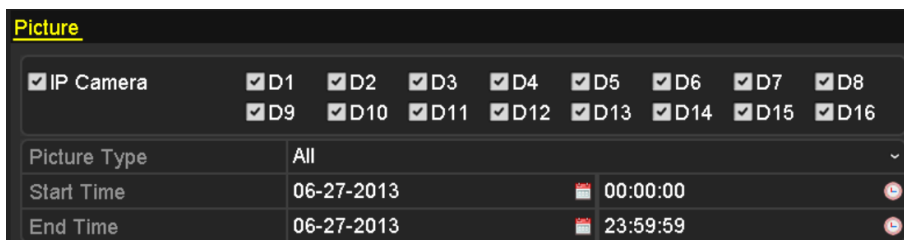

Figure 7.29 Picture Search for Backup

2. Select pictures you want to back up.
Check the checkbox before the pictures you want to back up and click **Export** button.



Here we take USB flash drive as an example. For more backup devices, please refer to *Chapter Backing up by Normal Video Search*.



Figure 7. 30 Result of Picture Search

3. Export.

Click **Export All** button to export all the recording files.

Or you can select recording files you want to back up, and click **Export** button to enter Export interface.



Figure 7. 31 Export Pictures Using USB Flash Drive

Stay in the Exporting interface until all record files are exported with pop-up message “Export finished”.

4. Check backup result.

7.3 Managing Backup Devices

Management of USB flash drives, USB HDDs and eSATA HDDs

Steps:

1. Enter Search Result interface of record files.

Menu>Export>Normal

Set search condition and click **Search** button to enter Search Result interface.



At least one channel shall be selected.

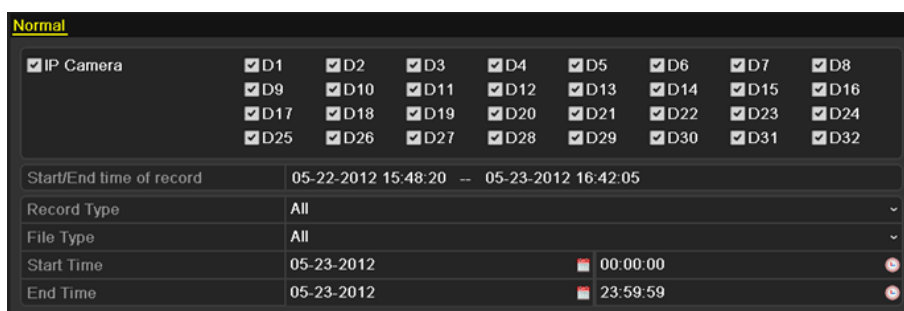

Figure 7.32 Normal Video Search for Backup

2. Click **Export All** button to export all the recording files.

Or you can select recording files you want to back up, and click **Export** button to enter Export interface.



At least one record file shall be selected.

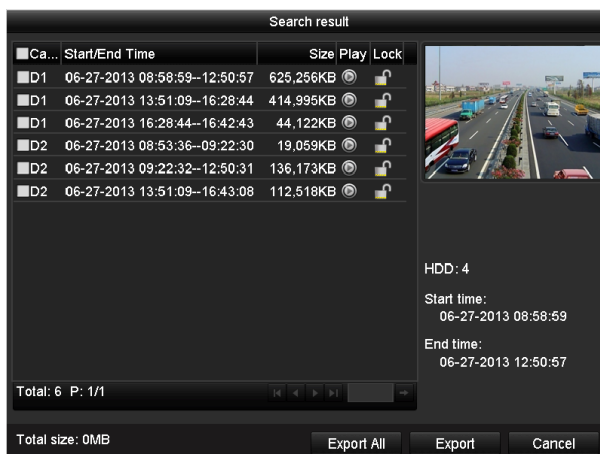

Figure 7.33 Result of Normal Video Search for Backup

3. Backup device management.

Click **New Folder** button if you want to create a new folder in the backup device.

Select a record file or folder in the backup device and click button if you want to delete it.

Select a record file in the backup device and click button to play it.

Click **Format** button to format the backup device.



If the inserted USB device is not recognized:

- Click the **Refresh** button.
- Reconnect device.
- Check for compatibility from vendor.

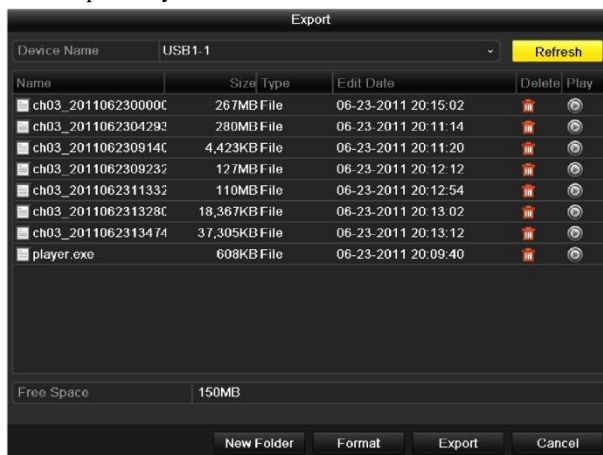

Figure 7.34 USB Flash Drive Management

Management of USB writers and DVD-R/W

1. Enter Search Result interface of record files.

Menu>Export>Normal

Set search condition and click **Search** button to enter Search Result interface.



At least one channel shall be selected.

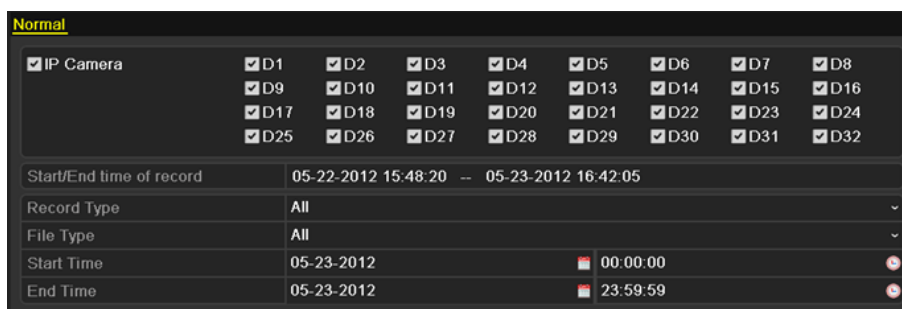

Figure 7.35 Normal Video Search for Backup

2. Select record files you want to back up.

Click **Export All** button to export all the recording files.

Or you can select recording files you want to back up, and click **Export** button to enter Export interface.



At least one recording file shall be selected.

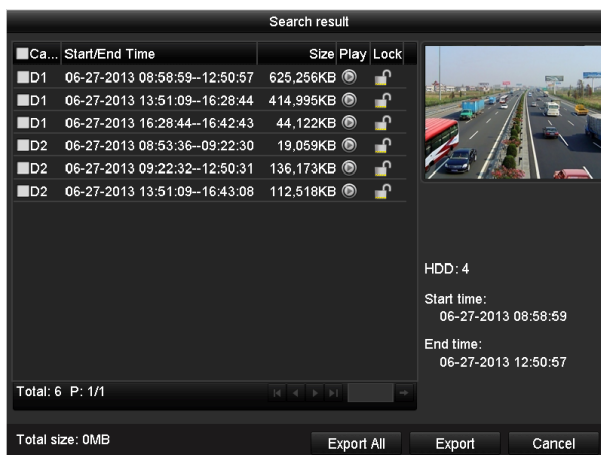

Figure 7. 36 Result of Normal Video Search for Backup

3. Backup device management.

Click **Erase** button if you want to erase the files from a re-writable CD/DVD.



- There must be a re-writable CD/DVD when you make this operation.
- If the inserted USB writer or DVD-R/W is not recognized:
 - Click the **Refresh** button.
 - Reconnect device.
 - Check for compatibility from vendor.



Figure 7. 37 USB Writer Management

7.4 Hot Spare Device Backup

Purpose:

Several devices, including NVR and HDVR, can form an N+1 hot spare system. The system consists of several working devices and a hot spare device; when the working device fails, the hot spare device switches into operation, thus increasing the reliability of the system.



Please contact dealer for details of models which support the hot spare function.

Before you start:

At least 2 devices are online.

A bidirectional connection shown in the figure below is required to be built between the hot spare device and each working device.

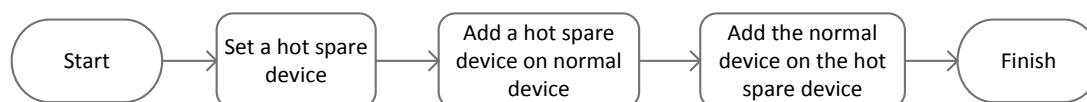

Figure 7.38 Building Hot Spare System

7.4.1 Setting Hot Spare Device



- The camera connection will be disabled when the device works in the hot spare mode.
- It's highly recommended to restore the defaults of the device after switching the working mode of the hot spare device to normal mode to ensure the normal operation afterwards.

Steps:

1. Enter the Hot Spare settings interface.
Menu > Configuration > Hot Spare
2. Set the Work Mode as Hot Spare Mode, click the **Apply** button to confirm the settings.
3. Reboot the device to make the change take effect.

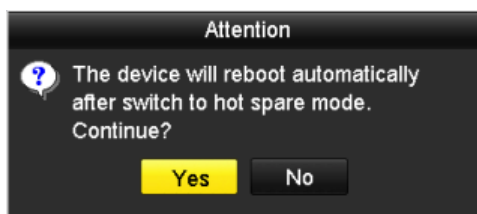

Figure 7.39 Reboot Attention

4. Click the **Yes** button in the pop-up attention box.

7.4.2 Setting Working Device

Steps:

1. Enter the Hot Spare settings interface.
Menu > Configuration > Hot Spare
2. Set the Work Mode as Normal Mode (default).
3. Check the checkbox of Enable to enable the hot spare function.
4. Enter the IP address and admin password of hot spare device.

The screenshot shows the 'General' settings for the Hot Spare function. It includes a 'Work Mode' section with radio buttons for 'Normal Mode' (selected) and 'Hot Spare Mode'. Below this is an 'Enable' checkbox which is checked. The 'IPv4 address of the hot s...' field contains '172.6.23.187'. The 'Password of the hot spar...' field is masked with asterisks. A 'Working Status' section shows 'Connected'. A note at the bottom states: 'Note: After the hot spare is enabled, you must link the working device to the hot spare device, otherwise, this function is not available.'

Figure 7. 40 Setting Working Mode for Working device

5. Click the **Apply** button to save the settings.

7.4.3 Managing Hot Spare System

Steps:

1. Enter the Hot Spare Settings interface of the hot spare device.
Menu > Configuration > Hot Spare
The connected working device is displayed on the device list.
2. Check the checkbox to select the working device from the device list, and click the **Add** button to link the working device to the hot spare device.



A hot spare device can connect up to 32 working devices.

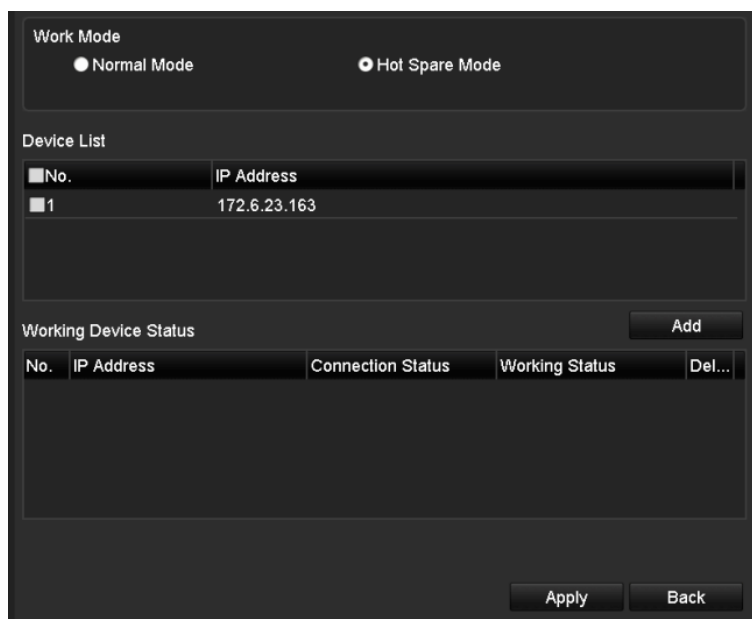

Figure 7. 41 Add Working Device

3. You can view the working status of the hot spare device on the Working Status list.
 When the working device works properly, the working status of the hot spare device is displayed as *No record*.

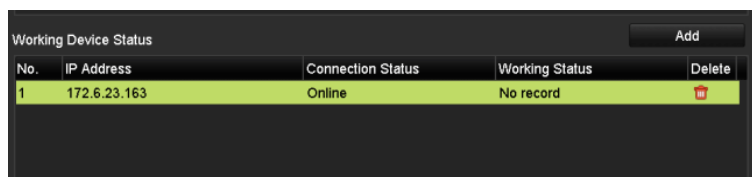

Figure 7. 42 No Recording

When the working device gets offline, the hot spare device will record the video of the IP Camera connected to the working device for backup, and the working status of the hot spare device is displayed as *Backing up*.



The record backing up can be functioned for 1 working device at a time.

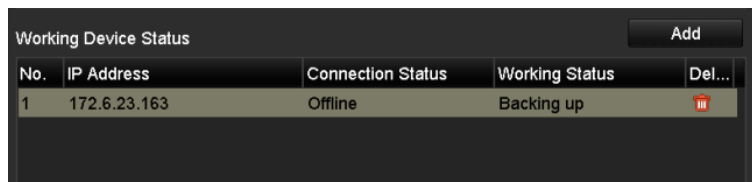

Figure 7. 43 Backing up

When the working device comes online, the lost video files will be restored by the record synchronization function, and the working status of the hot spare device is displayed as *Synchronizing*.



The record synchronization function can be enabled for 1 working device at a time.

No.	IP Address	Connection Status	Working Status	Del...
1	172.6.23.163	Online	Synchronizing (99%)	

Figure 7. 44 Synchronizing

Chapter 8 Alarm Settings

8.1 Setting Motion Detection Alarm

Steps:

1. Enter Motion Detection interface of Camera Management and choose a camera you want to set up motion detection.

Menu> Camera> Motion

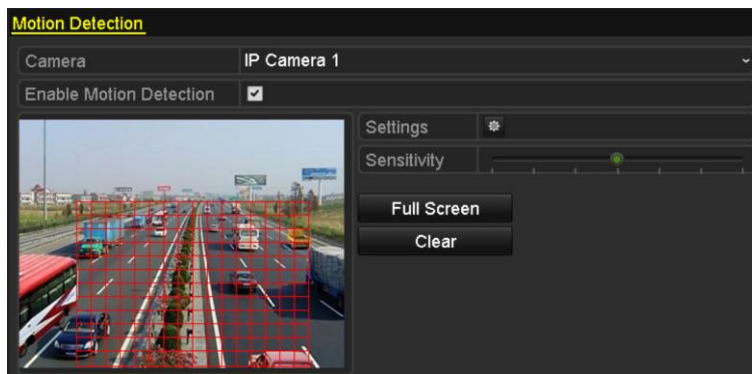



Figure 8.1 Motion Detection Setup Interface

2. Set up detection area and sensitivity.

Tick “Enable Motion Detection”, use the mouse to draw detection area(s) and drag the sensitivity bar to set sensitivity.

Click  button and set alarm response actions.

3. Click **Trigger Channel** tab and select one or more channels which will start to record/capture or become full-screen monitoring when motion alarm is triggered, and click **Apply** to save the settings.



Figure 8.2 Set Trigger Camera of Motion Detection

4. Set up arming schedule of the channel.

- 1) Select Arming Schedule tab to set the arming schedule of handling actions for the motion detection.
- 2) Choose one day of a week and up to eight time periods can be set within each day.
- 3) Click **Apply** to save the settings



Time periods shall not be repeated or overlapped.



Figure 8. 3 Set Arming Schedule of Motion Detection

5. Click **Handling** tab to set up alarm response actions of motion alarm (please refer to *Chapter Setting Alarm Response Actions*).
6. If you want to set motion detection for another channel, repeat the above steps or just click **Copy** in the Motion Detection interface to copy the above settings to it.

8.2 Setting Sensor Alarms

Purpose:

Set the handling action of an external sensor alarm.

Steps:

1. Enter Alarm Settings of System Configuration and select an alarm input.

Menu> Configuration> Alarm

Select Alarm Input tab to enter Alarm Input Settings interface.

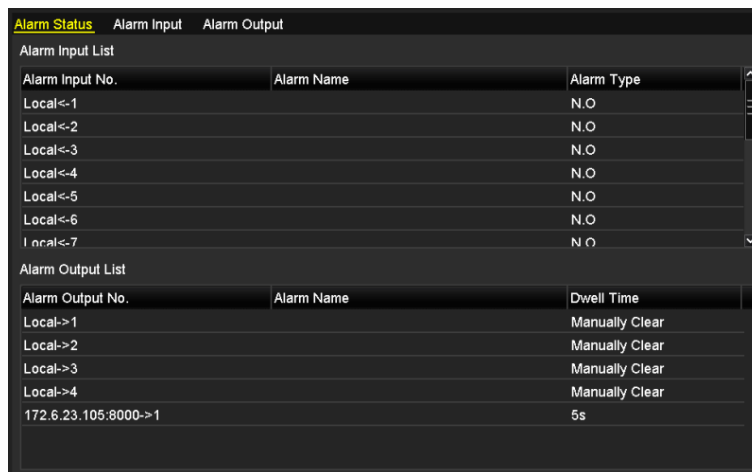

Figure 8. 4 Alarm Status Interface of System Configuration

2. Set up the handling action of the selected alarm input.

Check the **Enable** checkbox and click **Settings** button to set up its alarm response actions.



Figure 8. 5 Alarm Input Setup Interface

3. Select Trigger Channel tab and select one or more channels which will start to record/capture or become full-screen monitoring when an external alarm is input, and click **Apply** to save the settings.
4. Select **Arming Schedule** tab to set the arming schedule of handling actions.

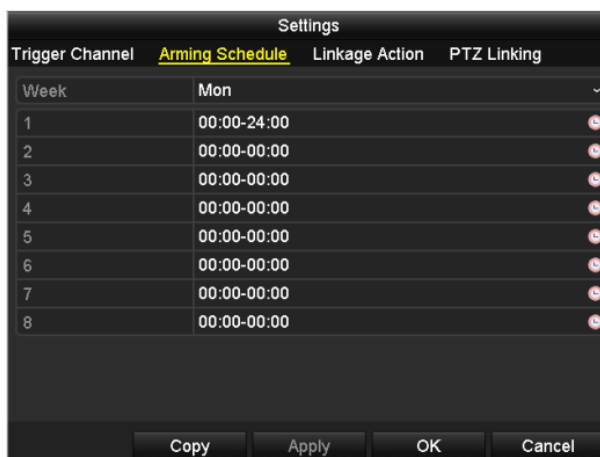

Figure 8. 6 Set Arming Schedule of Alarm Input

Choose one day of a week and Max. eight time periods can be set within each day, and click **Apply** to save the settings.



Time periods shall not be repeated or overlapped.

Repeat the above steps to set up arming schedule of other days of a week. You can also use **Copy** button to copy an arming schedule to other days.

5. Select **Linkage Action** tab to set up alarm response actions of the alarm input (please refer to *Chapter Setting Alarm Response Actions*).
6. If necessary, select **PTZ Linking** tab and set PTZ linkage of the alarm input.
Set PTZ linking parameters and click **OK** to complete the settings of the alarm input.



Please check whether the PTZ or speed dome supports PTZ linkage.

One alarm input can trigger presets, patrol or pattern of more than one channel. But presets, patrols and patterns are exclusive.

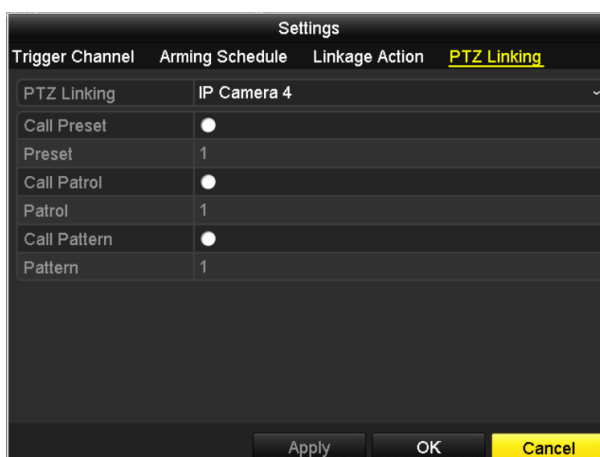

Figure 8. 7 Set PTZ Linking of Alarm Input

7. If you want to set handling action of another alarm input, repeat the above steps.
Or you can click the **Copy** button on the Alarm Input Setup interface and check the checkbox of alarm inputs

to copy the settings to them.

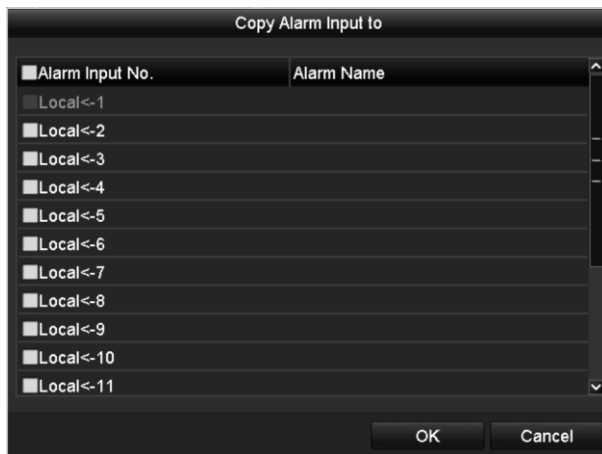

Figure 8. 8 Copy Settings of Alarm Input

8.3 Detecting Video Loss Alarm

Purpose:

Detect video loss of a channel and take alarm response action(s).

Steps:

1. Enter Video Loss interface of Camera Management and select a channel you want to detect.

Menu> Camera> Video Loss

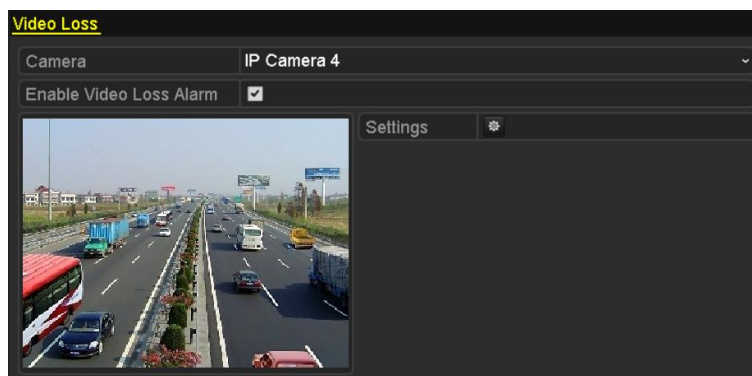



Figure 8.9 Video Loss Setup Interface

2. Set up handling action of video loss.

Check the checkbox of “Enable Video Loss Alarm”, and click  button to set up handling action of video loss.

3. Set up arming schedule of the handling actions.

- 1) Select Arming Schedule tab to set the channel’s arming schedule.
- 2) Choose one day of a week and up to eight time periods can be set within each day.
- 3) Click **Apply** button to save the settings.



Time periods shall not be repeated or overlapped.

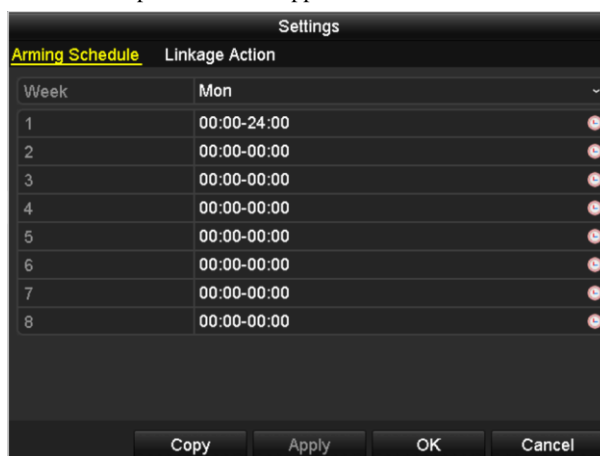

Figure 8.10 Set Arming Schedule of Video Loss

4. Select **Linkage Action** tab to set up alarm response action of video loss (please refer to *Chapter Setting Alarm Response Actions*).

5. Click the **OK** button to complete the video loss settings of the channel.

8.4 Detecting Video Tampering Alarm

Purpose:

Trigger alarm when the lens is covered and take alarm response action(s).

Steps:

1. Enter Video Tampering interface of Camera Management and select a channel you want to detect video tampering.

Menu> Camera> Video Tampering

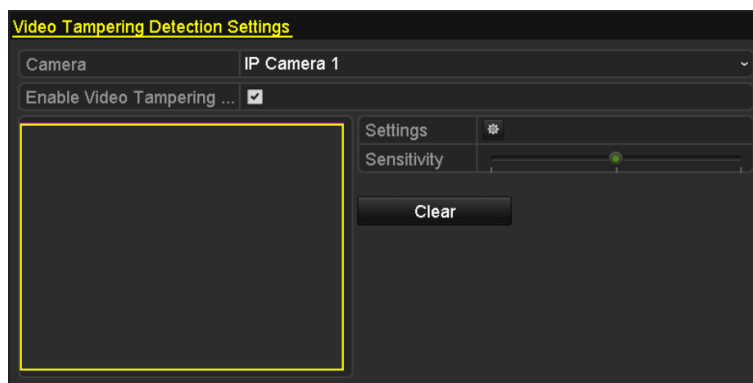



Figure 8. 11 Video Tampering Setting Interface

2. Set the video tampering handling action of the channel.
Check the checkbox of “Enable Video Tampering Detection”.
Drag the sensitivity bar to set a proper sensitivity level. Use the mouse to draw an area you want to detect video tampering.
Click  button to set up handling action of video tampering.
3. Set arming schedule and alarm response actions of the channel.
 - 1) Click Arming Schedule tab to set the arming schedule of handling actions.
 - 2) Choose one day of a week and Max. eight time periods can be set within each day.
 - 3) Click **Apply** button to save the settings.



Time periods shall not be repeated or overlapped.

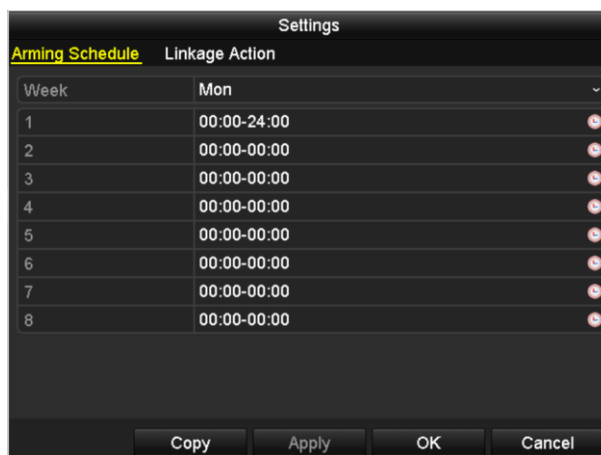

Figure 8.12 Set Arming Schedule of Video Tampering

4. Select **Linkage Action** tab to set up alarm response actions of video tampering alarm (please refer to *Chapter Setting Alarm Response Actions*).
5. Click the **OK** button to complete the video tampering settings of the channel.

8.5 Detecting VCA Alarm

Purpose:

The NVR can receive the VCA alarm sent by IP camera, and the VCA detection must be enabled and configured on the IP camera settings interface first. Refer to the user manual of IP camera for detailed instructions to set the VCA rules.

Steps:

1. Enter VCA Alarm interface of Camera Management and select a camera you want to detect VCA alarm.

Menu> Camera> VCA



The selected camera must support the VCA function.

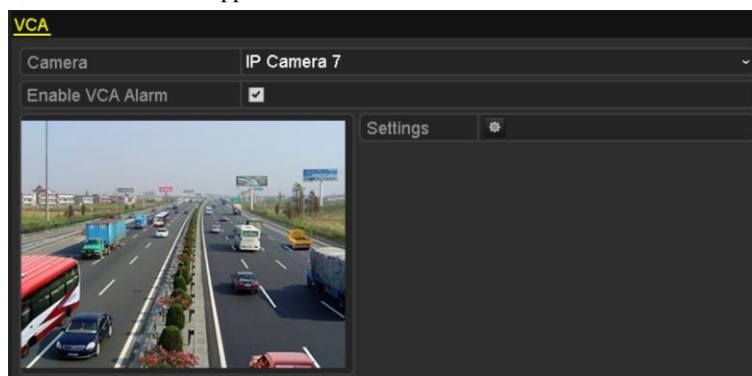

Figure 8.13 VCA Alarm Setting Interface

2. Check the **Enable VCA Alarm** checkbox and click **Settings** button to set up its alarm response actions.
3. Select Trigger Channel tab and select one or more channels which will start to record/capture or become full-screen monitoring when a VCA alarm is triggered, and click **Apply** to save the settings.
4. Select **Arming Schedule** tab to set the arming schedule of handling actions.

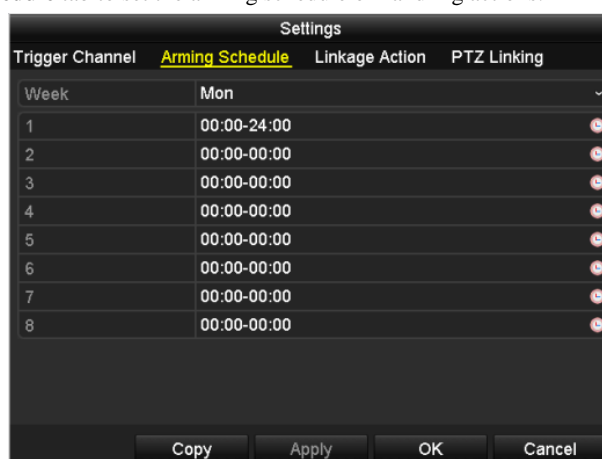

Figure 8.14 Set Arming Schedule of VCA Alarm

Choose one day of a week and Max. eight time periods can be set within each day, and click **Apply** to save the settings.



Time periods shall not be repeated or overlapped.

Repeat the above steps to set up arming schedule of other days of a week. You can also use **Copy** button to copy an arming schedule to other days.

5. Select **Linkage Action** tab to set up alarm response actions of the alarm input (please refer to *Chapter 8.7 Setting Alarm Response Actions*).
6. If necessary, select PTZ Linking tab and set PTZ linkage of the VCA alarm, refer to step 6 of *Chapter 8.2 Setting Sensor Alarms*.
7. Click the **OK** button to complete the VCA alarm settings of the channel.

8.6 Handling Exceptions Alarm

Purpose:

Exception settings refer to the handling action of various exceptions, e.g.

- **HDD Full:** The HDD is full.
- **HDD Error:** Writing HDD error or unformatted HDD.
- **Network Disconnected:** Disconnected network cable.
- **IP Conflicted:** Duplicated IP address.
- **Illegal Login:** Incorrect user ID or password.
- **Record/Capture Exception:** No space for saving recorded files or captured images.
- **Hot Spare Exception:** Disconnected with the working device.
- **Array Exception:** Abnormal virtual disks exist under array.



Array Exception is only supported by DS-9600NI-RT and DS-9600NI-XT series NVR.

Steps:

Enter Exception interface of System Configuration and handle various exceptions.

Menu> Configuration> Exceptions

Please refer to *Chapter Setting Alarm Response Actions* for detailed alarm response actions.



Figure 8. 15 Exceptions Setup Interface

8.7 Setting Alarm Response Actions

Purpose:

Alarm response actions will be activated when an alarm or exception occurs, including Event Hint Display, Full Screen Monitoring, Audible Warning (buzzer), Notify Surveillance Center, Trigger Alarm Output and Send Email.

Event Hint Display

When an event or exception happens, a hint can be displayed on the lower-left corner of live view image. And you can click the hint icon to check the details. Besides, the event to be displayed is configurable.

Steps:

1. Enter the Exception settings interface.
Menu > Configuration > Exceptions
2. Check the checkbox of **Enable Event Hint**.

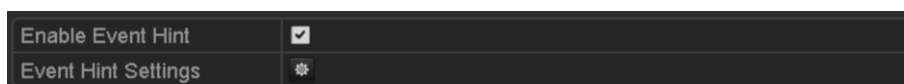



Figure 8. 16 Event Hint Settings Interface

3. Click the  to set the type of event to be displayed on the image.

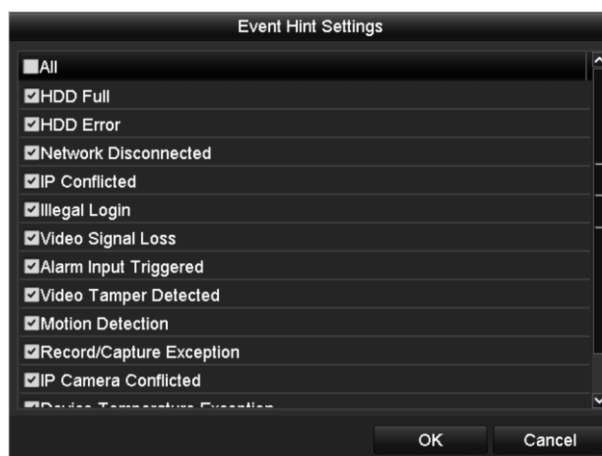

Figure 8. 17 Event Hint Settings Interface

4. Click the **OK** button to finish settings.

Full Screen Monitoring

When an alarm is triggered, the local monitor (VGA, HDMI or BNC monitor) display in full screen the video image from the alarming channel configured for full screen monitoring.

If alarms are triggered simultaneously in several channels, their full-screen images will be switched at an interval of 10 seconds (default dwell time). A different dwell time can be set by going to Menu > Configuration > Live View > Full Screen Monitoring Dwell Time.

Auto-switch will terminate once the alarm stops and you will be taken back to the Live View interface.



You must select during “Trigger Channel” settings the channel(s) you want to make full screen monitoring.

Audible Warning

Trigger an audible *beep* when an alarm is detected.

Notify Surveillance Center

Sends an exception or alarm signal to remote alarm host when an event occurs. The alarm host refers to the PC installed with Remote Client.



The alarm signal will be transmitted automatically at detection mode when remote alarm host is configured. Please refer to *Chapter Configuring Remote Alarm Host* for details of alarm host configuration.

Email Linkage

Send an email with alarm information to a user or users when an alarm is detected. Please refer to *Chapter 9.2.10* for details of Email configuration.

Trigger Alarm Output

Trigger an alarm output when an alarm is triggered.

1. Enter Alarm Output interface.

Menu> Configuration> Alarm> Alarm Output

Select an alarm output and set alarm name and dwell time. Click **Schedule** button to set the arming schedule of alarm output.



If “Manually Clear” is selected in the dropdown list of Dwell Time, you can clear it only by going to Menu> Manual> Alarm.

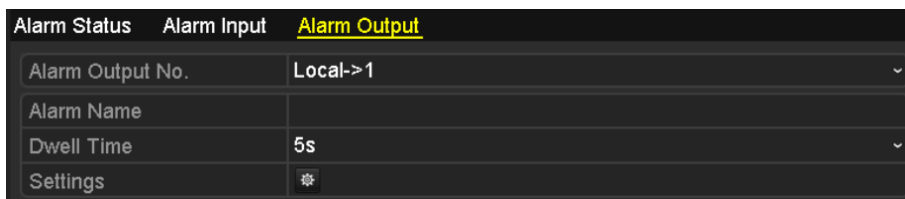

Figure 8. 18 Alarm Output Setup Interface

2. Set up arming schedule of the alarm output.

Choose one day of a week and up to 8 time periods can be set within each day.



Time periods shall not be repeated or overlapped.

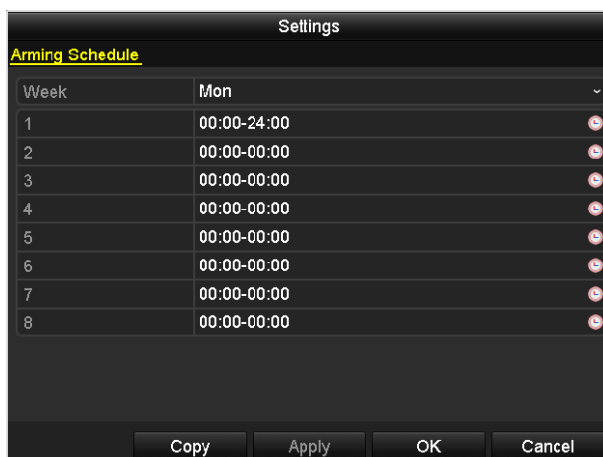

Figure 8.19 Set Arming Schedule of Alarm Output

- Repeat the above steps to set up arming schedule of other days of a week. You can also use **Copy** button to copy an arming schedule to other days.

Click the **OK** button to complete the video tampering settings of the alarm output No.

- You can also copy the above settings to another channel.

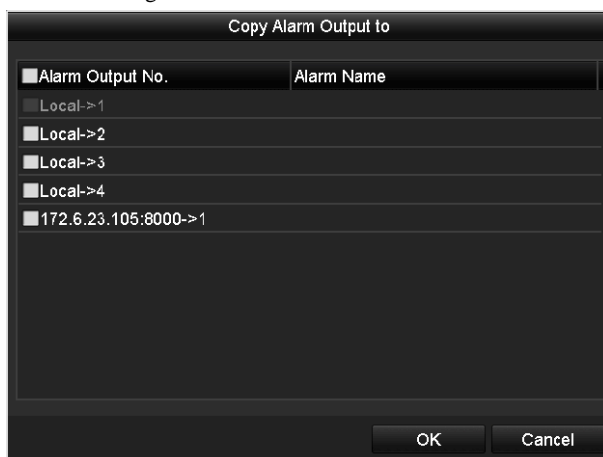

Figure 8.20 Copy Settings of Alarm Output

8.8 Triggering or Clearing Alarm Output Manually

Purpose:

Sensor alarm can be triggered or cleared manually. If “Manually Clear” is selected in the dropdown list of dwell time of an alarm output, the alarm can be cleared only by clicking **Clear** button in the following interface.

Steps:

Select the alarm output you want to trigger or clear and make related operations.

Menu> Manual> Alarm

Click **Trigger/Clear** button if you want to trigger or clear an alarm output.

Click **Trigger All** button if you want to trigger all alarm outputs.

Click **Clear All** button if you want to clear all alarm output.

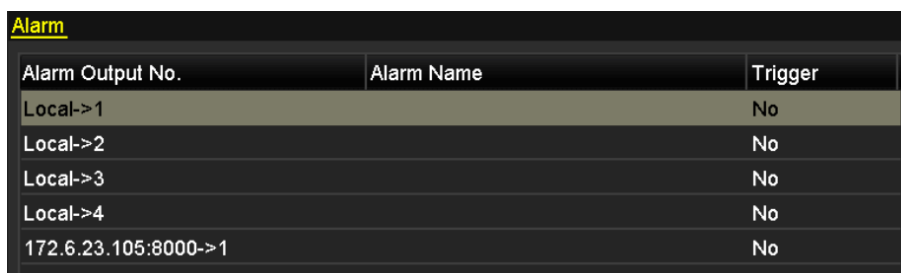

Alarm Output No.	Alarm Name	Trigger
Local->1		No
Local->2		No
Local->3		No
Local->4		No
172.6.23.105:8000->1		No

Figure 8. 21 Clear or Trigger Alarm Output Manually

Chapter 9 Network Settings

9.1 Configuring General Settings

Purpose:

Network settings must be properly configured before you operate NVR over network.

Steps:

1. Enter the Network Settings interface.
Menu >Configuration>Network
2. Select the **General** tab.

Working Mode	Net Fault-tolerance
Select NIC	bond0
NIC Type	10M/100M/1000M Self-adaptive
Enable DHCP	<input type="checkbox"/>
IPv4 Address	172 .6 .21 .159
IPv4 Subnet Mask	255 .255 .255 .0
IPv4 Default Gateway	172 .6 .21 .1
IPv6 Address 1	fec0::a:240:48ff:fe62:dcd/64
IPv6 Address 2	2002:ac06:1578:a:240:48ff:fe62:dcd/64
IPv6 Default Gateway	
MAC Address	00:40:48:62:0d:cd
MTU(Bytes)	1500
Preferred DNS Server	
Alternate DNS Server	
Main NIC	LAN1

DS-9600NI-ST/RT/XT and DS-8600NI-ST

NIC Type	10M/100M/1000M Self-adaptive
Enable DHCP	<input type="checkbox"/>
IPv4 Address	172 .6 .23 .190
IPv4 Subnet Mask	255 .255 .255 .0
IPv4 Default Gateway	172 .6 .23 .1
IPv6 Address 1	fe80::212:42ff:fe6d:ec46/64
IPv6 Address 2	
IPv6 Default Gateway	
MAC Address	00:12:42:fd:ec:46
MTU(Bytes)	1500
Preferred DNS Server	
Alternate DNS Server	

DS-7700/7600NI-ST

NIC Type	10M/100M/1000M Self-adaptive
Enable DHCP	<input type="checkbox"/>
IPv4 Address	172 .6 .23 .190
IPv4 Subnet Mask	255 .255 .255 .0
IPv4 Default Gateway	172 .6 .23 .1
IPv6 Address 1	fe80::212:42ff:fe6d:ec46/64
IPv6 Address 2	
IPv6 Default Gateway	
MAC Address	00:12:42:fd:ec:46
MTU(Bytes)	1500
Preferred DNS Server	
Alternate DNS Server	
Internal NIC IPv4 Address	192 .168 .254 .1

DS-7700/7600NI-SP

Figure 9. 1 Network Settings Interface



Dual-NIC configuration is only applicable for DS-9600NI-ST/RT/XT and DS-8600NI-ST series NVR.

3. In the **General Settings** interface, you can configure the following settings: Working Mode, NIC Type, IPv4 Address, IPv4 Gateway, MTU and DNS Server.

If the DHCP server is available, you can click the checkbox of **DHCP** to automatically obtain an IP address and other network settings from that server.



- For the 7600/7700NI-SP series NVR, you need to configure the internal NIC address, so that IP addresses are assigned to the cameras connected to the PoE interfaces.
 - The valid value range of MTU is 500 ~ 9676.
4. After having configured the general settings, click **Apply** button to save the settings.

Working Mode

There are two 10M/100M/1000M NIC cards provided by the 9600NI-ST/RT/XT series device, and it allows the device to work in the Multi-address, Load Balance and Net-fault Tolerance modes.

Multi-address Mode: The parameters of the two NIC cards can be configured independently. You can select LAN1 or LAN2 in the NIC type field for parameter settings.

You can select one NIC card as default route. And then the system is connecting with the extranet the data will be forwarded through the default route.

Net-fault Tolerance Mode: The two NIC cards use the same IP address, and you can select the Main NIC to LAN1 or LAN2. By this way, in case of one NIC card failure, the device will automatically enable the other standby NIC card so as to ensure the normal running of the whole system.

Load Balance Mode: By using the same IP address and two NIC cards share the load of the total bandwidth, which enables the system to provide two Gigabit network capacity.

Working Mode	Net Fault-tolerance
Select NIC	bond0
NIC Type	10M/100M/1000M Self-adaptive
Enable DHCP	<input type="checkbox"/>
IPv4 Address	172 .6 .21 .159
IPv4 Subnet Mask	255 .255 .255 .0
IPv4 Default Gateway	172 .6 .21 .1
IPv6 Address 1	fec0::a:240:48ff:fe62:dcd/64
IPv6 Address 2	2002:ac06:1578:a:240:48ff:fe62:dcd/64
IPv6 Default Gateway	
MAC Address	00:40:48:62:0d:cd
MTU(Bytes)	1500
Preferred DNS Server	
Alternate DNS Server	
Main NIC	LAN1

Figure 9. 2 Net Fault-tolerance Working Mode

9.2 Configuring Advanced Settings

9.2.1 Configuring PPPoE Settings

Purpose:

Your NVR also allows access by Point-to-Point Protocol over Ethernet (PPPoE).

Steps:

1. Enter the **Network Settings** interface.
Menu >Configuration> Network
2. Select the **PPPoE** tab to enter the PPPoE Settings interface, as shown in Figure 9. 3.

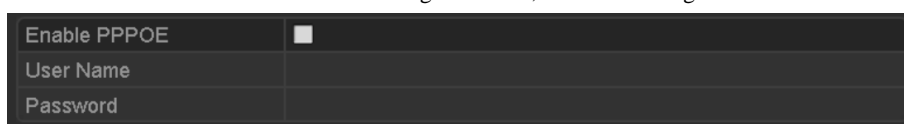

Enable PPPOE	<input type="checkbox"/>
User Name	<input type="text"/>
Password	<input type="text"/>

Figure 9. 3 PPPoE Settings Interface

3. Check the **PPPoE** checkbox to enable this feature.
 4. Enter **User Name**, and **Password** for PPPoE access.
-  The User Name and Password should be assigned by your ISP.
5. Click the **Apply** button to save and exit the interface.
 6. After successful settings, the system asks you to reboot the device to enable the new settings, and the PPPoE dial-up is automatically connected after reboot.

You can go to Menu >Maintenance>System Info >Network interface to view the status of PPPoE connection.

Please refer to *Chapter Viewing System Information* for PPPoE status.

9.2.2 Configuring DDNS

Purpose:

If your NVR is set to use PPPoE as its default network connection, you may set Dynamic DNS (DDNS) to be used for network access.

Prior registration with your ISP is required before configuring the system to use DDNS.

Steps:

1. Enter the Network Settings interface.
Menu >Configuration> Network
2. Select the **DDNS** tab to enter the DDNS Settings interface, as shown in Figure 9. 4.

Enable DDNS	<input type="checkbox"/>
DDNS Type	IPServer
Server Address	
Device Domain Name	
User Name	
Password	
Confirm	

Figure 9. 4 DDNS Settings Interface

3. Check the **DDNS** checkbox to enable this feature.
4. Select **DDNS Type**. Five different DDNS types are selectable: IPSEver, DynDNS, PeanutHull, NO-IP and HiDDNS.
 - **IPSEver:** Enter **Server Address** for IPSEver.

Enable DDNS	<input checked="" type="checkbox"/>
DDNS Type	IPSEver
Server Address	
Device Domain Name	
User Name	
Password	
Confirm	

Figure 9. 5 IPSEver Settings Interface

- **DynDNS:**
 - 1) Enter **Server Address** for DynDNS (i.e. members.dyndns.org).
 - 2) In the NVR Domain Name text field, enter the domain obtained from the DynDNS website.
 - 3) Enter the **User Name** and **Password** registered in the DynDNS website.

Enable DDNS	<input checked="" type="checkbox"/>
DDNS Type	DynDNS
Server Address	
Device Domain Name	
User Name	
Password	
Confirm	

Figure 9. 6 DynDNS Settings Interface

- **PeanutHull:** Enter the **User Name** and **Password** obtained from the PeanutHull website.

Enable DDNS	<input checked="" type="checkbox"/>
DDNS Type	PeanutHull
Server Address	
Device Domain Name	
User Name	
Password	
Confirm	

Figure 9. 7 PeanutHull Settings Interface

- **NO-IP:**

Enter the account information in the corresponding fields. Refer to the DynDNS settings.

 - 1) Enter **Server Address** for NO-IP.

- 2) In the NVR Domain Name text field, enter the domain obtained from the NO-IP website (www.no-ip.com).
- 3) Enter the **User Name** and **Password** registered in the NO-IP website.

Enable DDNS	<input checked="" type="checkbox"/>
DDNS Type	NO-IP
Server Address	
Device Domain Name	
User Name	
Password	
Confirm	

Figure 9. 8 NO-IP Settings Interface

• **HiDDNS:**

- 1) The **Server Address** of the HiDDNS server appears by default: www.hiddns.com.
- 2) Enter the **Device Domain Name**. You can use the alias you registered in the HiDDNS server or define a new device domain name. If a new alias of the device domain name is defined in the NVR, it will replace the old one registered on the server. You can register the alias of the device domain name in the HiDDNS server first and then enter the alias to the **Device Domain Name** in the NVR; you can also enter the domain name directly on the NVR to create a new one.

Enable DDNS	<input checked="" type="checkbox"/>
DDNS Type	HiDDNS
Server Address	www.hiddns.com
Device Domain Name	intelligent
User Name	
Password	
Confirm	

Figure 9. 9 HiDDNS Settings Interface

Register the device on the HiDDNS server.

- 1) Go to the HiDDNS website: www.hiddns.com.
- 2) Click [Register new user](#) to register an account if you do not have one and use the account to log in.

Figure 9. 10 Register an Account

- 3) In the Device Management interface, click  to register the device.

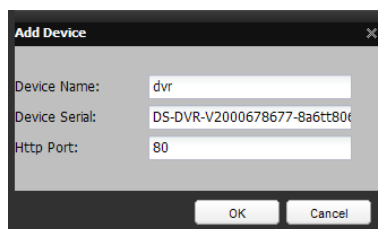

Figure 9. 11 Register the Device



The device name can only contain the lower-case English letter, numeric and '-'; and it must start with the lower-case English letter and cannot end with '-'.

Access the Device via Web Browser or Client Software

After having successfully registered the device on the HiDDNS server, you can access your device via web browser or Client Software with the **Device Domain Name (Device Name)**.

● **OPTION 1: Access the Device via Web Browser**

Open a web browser, and enter *http://www.hiddns.com/alias* in the address bar. Alias refers to the **Device Domain Name** on the device or the **Device Name** on the HiDDNS server.

Example: http://www.hiddns.com/nvr



If you mapped the HTTP port on your router and changed it to port No. except 80, you have to enter *http://www.hiddns.com/alias:HTTP port* in the address bar to access the device. You can refer to *Chapter 9.2.11* for the mapped HTTP port No.

● **OPTION 2: Access the devices via iVMS4200**

For iVMS-4200, in the Add Device window, select **HiDDNS** and then edit the device information.

Nickname: Edit a name for the device as you want.

Server Address: www.hiddns.com

Device Domain Name: It refers to the **Device Domain Name** on the device or the **Device Name** on the HiDDNS server you created.

User Name: Enter the user name of the device. By default it is admin.

Password: Enter the password of the device. By default it is 12345.

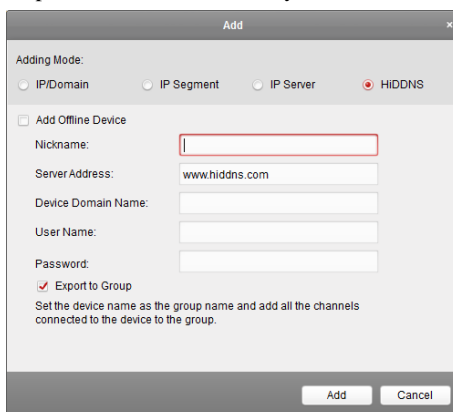

Figure 9. 12 Access Device via iVMS4200

5. Click the **Apply** button to save and exit the interface.

9.2.3 Configuring NTP Server

Purpose:

A Network Time Protocol (NTP) Server can be configured on your NVR to ensure the accuracy of system date/time.

Steps:

1. Enter the Network Settings interface.
Menu >Configuration> Network
2. Select the **NTP** tab to enter the NTP Settings interface, as shown in Figure 9. 13.

Enable NTP	<input checked="" type="checkbox"/>
Interval (min)	60
NTP Server	
NTP Port	123

Figure 9. 13 NTP Settings Interface

3. Check the **Enable NTP** checkbox to enable this feature.
4. Configure the following NTP settings:
 - **Interval:** Time interval between the two synchronizing actions with NTP server. The unit is minute.
 - **NTP Server:** IP address of NTP server.
 - **NTP Port:** Port of NTP server.
5. Click the **Apply** button to save and exit the interface.



The time synchronization interval can be set from 1 to 10080min, and the default value is 60min. If the NVR is connected to a public network, you should use a NTP server that has a time synchronization function, such as the server at the National Time Center (IP Address: 210.72.145.44). If the NVR is setup in a more customized network, NTP software can be used to establish a NTP server used for time synchronization.

9.2.4 Configuring SNMP

Purpose:

You can use SNMP protocol to get device status and parameters related information.

Steps:

1. Enter the Network Settings interface.
Menu >Configuration> Network
2. Select the **SNMP** tab to enter the SNMP Settings interface, as shown in Figure 9. 14.

Enable SNMP	<input checked="" type="checkbox"/>
SNMP Version	V2
SNMP Port	161
Read Community	public
Write Community	private
Trap Address	
Trap Port	162

Figure 9. 14 SNMP Settings Interface

3. Check the **SNMP** checkbox to enable this feature.
4. Configure the following SNMP settings:
 - **Trap Address:** IP Address of SNMP host.
 - **Trap Port:** Port of SNMP host.
5. Click the **Apply** button to save and exit the interface.



Before setting the SNMP, please download the SNMP software and manage to receive the device information via SNMP port. By setting the Trap Address, the NVR is allowed to send the alarm event and exception message to the surveillance center.

9.2.5 Configuring Remote Alarm Host

Purpose:

With a remote alarm host configured, the NVR will send the alarm event or exception message to the host when an alarm is triggered. The remote alarm host must have the Network Video Surveillance software installed.

Steps:

1. Enter the Network Settings interface.
Menu >Configuration> Network
2. Select the **More Settings** tab to enter the More Settings interface, as shown in Figure 9. 15.

Alarm Host IP	
Alarm Host Port	0
Server Port	8000
HTTP Port	80
Multicast IP	
RTSP Port	554
Enable High-speed Dow...	<input type="checkbox"/>

Figure 9. 15 More Settings Interface

3. Enter **Alarm Host IP** and **Alarm Host Port** in the text fields.
The **Alarm Host IP** refers to the IP address of the remote PC on which the Network Video Surveillance Software (e.g., iVMS-4200) is installed, and the **Alarm Host Port** must be the same as the alarm monitoring port configured in the software.
4. Click the **Apply** button to save and exit the interface.

9.2.6 Configuring Multicast

Purpose:

The multicast can be configured to realize live view for more than 128 connections through network for the device. A multicast address spans the Class-D IP range of 224.0.0.0 to 239.255.255.255. It is recommended to use the IP address ranging from 239.252.0.0 to 239.255.255.255.

Steps:

1. Enter the Network Settings interface.
Menu >Configuration> Network
2. Select the **More Settings** tab to enter the More Settings interface, as shown in Figure 9. 15.
3. Set **Multicast IP**, as shown in Figure 9. 16. When adding a device to the Network Video Surveillance Software, the multicast address must be the same as the NVR’s multicast IP.

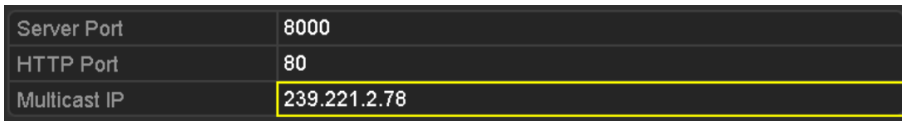

Figure 9. 16 Configure Multicast

4. Click the **Apply** button to save and exit the interface.



The multicast function should be supported by the network switch to which the NVR is connected.

9.2.7 Configuring RTSP

Purpose:

The RTSP (Real Time Streaming Protocol) is a network control protocol designed for use in communication systems to control streaming media servers.

Steps:

1. Enter the Network Settings menu
Menu >Configuration> Network
2. Select the **More Settings** tab to enter the More Settings menu, as shown in Figure 9. 15.

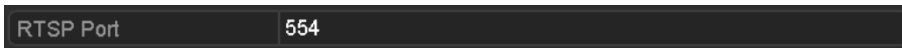

Figure 9. 17 RTSP Settings Interface

3. Enter the RTSP port in the text field of **RTSP Service Port**. The default RTSP port is 554, and you can change it according to different requirements.
4. Click the **Apply** button to save and exit the menu.

9.2.8 Configuring Server and HTTP Ports

Purpose:

You can change the server and HTTP ports in the Network Settings menu. The default server port is 8000 and the default HTTP port is 80.

Steps:

1. Enter the Network Settings interface.
Menu > Configuration > Network
2. Select the **More Settings** tab to enter the More Settings interface, as shown in Figure 9. 15.
3. Enter new **Server Port** and **HTTP Port**.

Server Port	8000
HTTP Port	80
Multicast IP	239.221.2.78

Figure 9. 18 Host/Others Settings Menu

4. Enter the Server Port and HTTP Port in the text fields. The default Server Port is 8000 and the HTTP Port is 80, and you can change them according to different requirements.
5. Click the **Apply** button to save and exit the interface.



The Server Port should be set to the range of 2000-65535 and it is used for remote client software access.
The HTTP port is used for remote web browser access.

9.2.9 Configuring HTTPS Port

Purpose:

HTTPS provides authentication of the web site and associated web server that one is communicating with, which protects against Man-in-the-middle attacks. Perform the following steps to set the port number of https.

Example:

If you set the port number as 443 and the IP address is 192.0.0.64, you may access the device by inputting `https://192.0.0.64:443` via the web browser.



The HTTPS port can be only configured through the web browser.

Steps:

1. Open web browser, input the IP address of device, and the web server will select the language automatically according to the system language and maximize the web browser.
2. Input the correct user name and password, and click **Login** button to log in the device.
3. Enter the HTTPS settings interface.
Configuration > Remote Configuration > Network Settings > HTTPS
4. Create the self-signed certificate or authorized certificate.

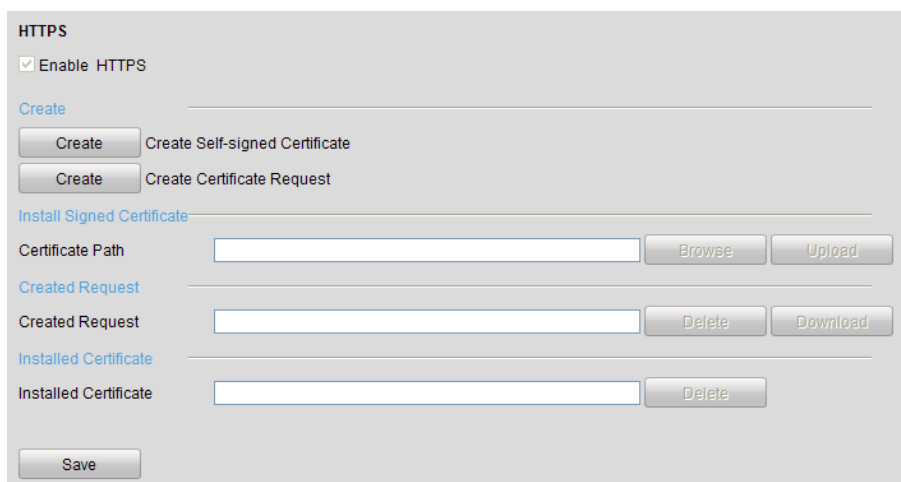

Figure 9. 19 HTTPS Settings

OPTION 1: Create the self-signed certificate

- 1) Click the **Create** button to create the following dialog box.

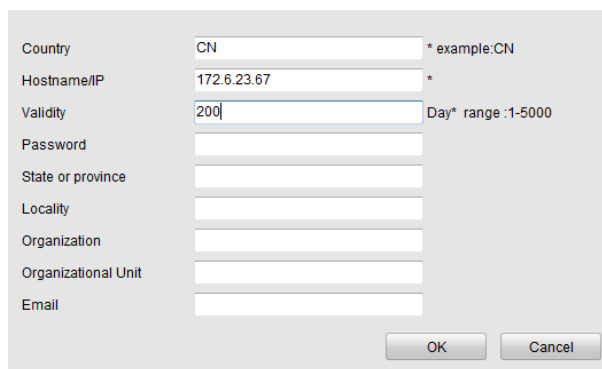

Figure 9. 20 Create Self-signed Certificate

- 2) Enter the country, host name/IP, validity and other information.
- 3) Click **OK** to save the settings.

OPTION 2: Create the authorized certificate

- 1) Click the **Create** button to create the certificate request.
 - 2) Download the certificate request and submit it to the trusted certificate authority for signature.
 - 3) After receiving the signed valid certificate, import the certificate to the device.
5. There will be the certificate information after you successfully create and install the certificate.

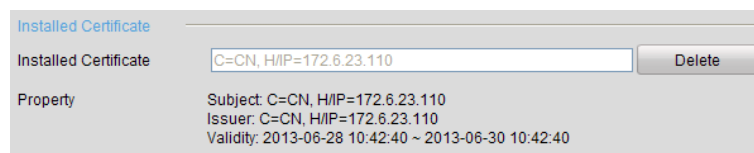

Figure 9. 21 Installed Certificate Property

6. Check the checkbox to enable the HTTPS function.
7. Click the **Save** button to save the settings.

9.2.10 Configuring Email

Purpose:

The system can be configured to send an Email notification to all designated users if an alarm event is detected, etc., an alarm or motion event is detected or the administrator password is changed.

Before configuring the Email settings, the NVR must be connected to a local area network (LAN) that maintains an SMTP mail server. The network must also be connected to either an intranet or the Internet depending on the location of the e-mail accounts to which you want to send notification.

Steps:

1. Enter the Network Settings interface.
Menu >Configuration> Network
2. Set the IPv4 Address, IPv4 Subnet Mask, IPv4 Gateway and the Preferred DNS Server in the Network Settings menu, as shown in Figure 9. 22.

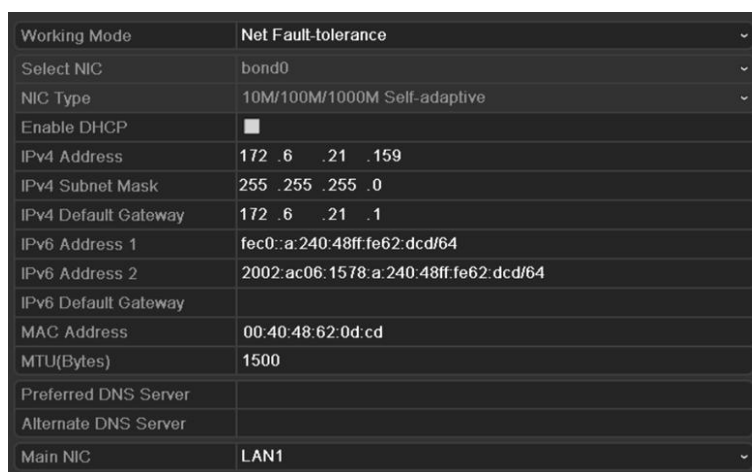

Figure 9. 22 Network Settings Interface

3. Click **Apply** to save the settings.
4. Select the Email tab to enter the Email Settings interface.

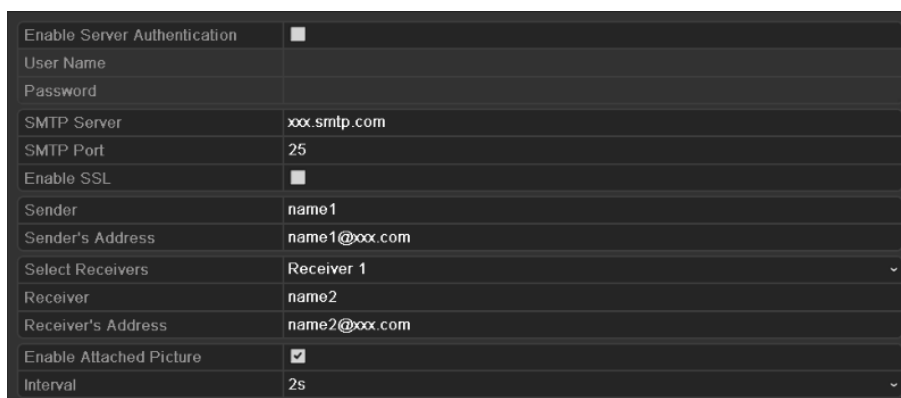

Figure 9. 23 Email Settings Interface

5. Configure the following Email settings:
Enable Server Authentication (optional): Check the checkbox to enable the server authentication feature.
User Name: The user name of sender's account registered on the SMTP server.

Password: The password of sender's account registered on the SMTP server.

SMTP Server: The SMTP Server IP address or host name (e.g., smtp.263xmail.com).

SMTP Port No.: The SMTP port. The default TCP/IP port used for SMTP is 25.

Enable SSL (optional): Click the checkbox to enable SSL if required by the SMTP server.

Sender: The name of sender.

Sender's Address: The Email address of sender.

Select Receivers: Select the receiver. Up to 3 receivers can be configured.

Receiver: The name of user to be notified.

Receiver's Address: The Email address of user to be notified.

Enable Attached Pictures: Check the checkbox of **Enable Attached Picture** if you want to send email with attached alarm images. The interval is the time of two adjacent alarm images. You can also set SMTP port and enable SSL here.

Interval: The interval refers to the time between two actions of sending attached pictures.

E-mail Test: Sends a test message to verify that the SMTP server can be reached.

6. Click **Apply** button to save the Email settings.
7. You can click **Test** button to test whether your Email settings work. The corresponding Attention message box will pop up. Refer to Figure 9. 24.

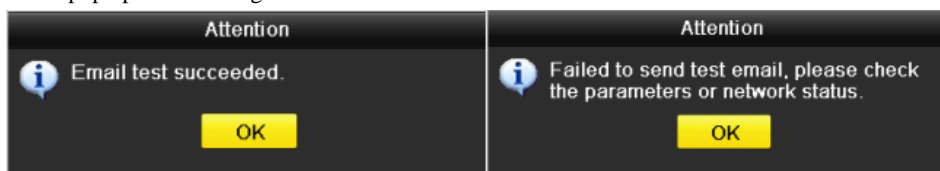

Figure 9. 24 Email Testing Attention

9.2.11 Configuring NAT

Purpose:

Two ways are provided for port mapping to realize the remote access via the cross-segment network, UPnP™ and manual mapping.

- **UPnP™**

Universal Plug and Play (UPnP™) can permit the device seamlessly discover the presence of other network devices on the network and establish functional network services for data sharing, communications, etc. You can use the UPnP™ function to enable the fast connection of the device to the WAN via a router without port mapping.

Before you start:

If you want to enable the UPnP™ function of the device, you must enable the UPnP™ function of the router to which your device is connected. When the network working mode of the device is set as multi-address, the Default Route of the device should be in the same network segment as that of the LAN IP address of the router.

Steps:

1. Enter the Network Settings interface.
Menu > Configuration > Network
2. Select the **NAT** tab to enter the port mapping interface.

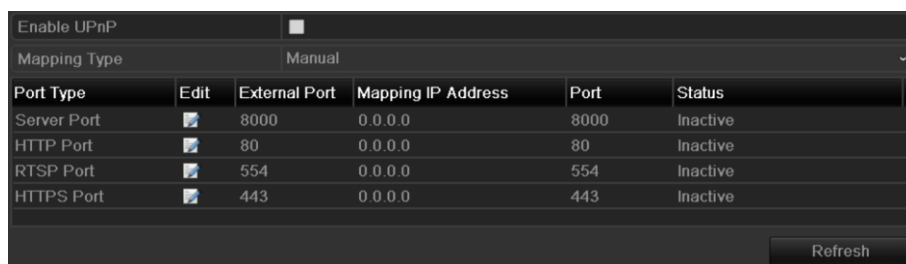

Figure 9. 25 UPnP™ Settings Interface

3. Check checkbox to enable UPnP™.
4. Select the Mapping Type as Manual or Auto in the drop-down list.

OPTION 1: Auto

If you select Auto, the Port Mapping items are read-only, and the external ports are set by the router automatically.

Steps:

- 1) Select **Auto** in the drop-down list of Mapping Type.
- 2) Click **Apply** button to save the settings.
- 3) You can click **Refresh** button to get the latest status of the port mapping.

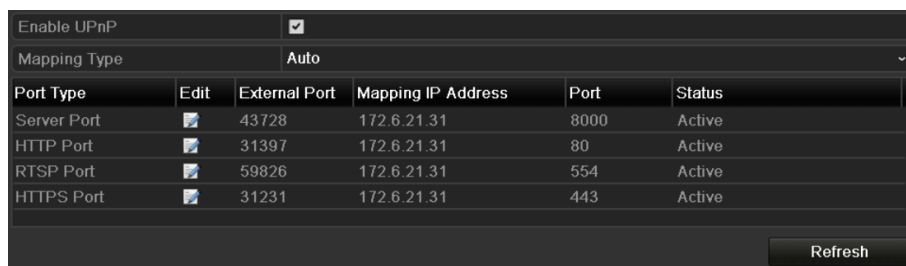

Figure 9. 26 UPnP™ Settings Finished-Auto

OPTION 2: Manual

If you select Manual as the mapping type, you can edit the external port on your demand by clicking to activate the External Port Settings dialog box.

Steps:

- 1) Select **Manual** in the drop-down list of Mapping Type.
- 2) Click to activate the External Port Settings dialog box. Configure the external port No. for server port, http port, RTSP port and https port respectively.



- You can use the default port No., or change it according to actual requirements.
- External Port indicates the port No. for port mapping in the router.
- The value of the RTSP port No. should be 554 or between 1024 and 65535, while the value of the other ports should be between 1 and 65535 and the value must be different from each other. If multiple devices are configured for the UPnP™ settings under the same router, the value of the port No. for each device should be unique.

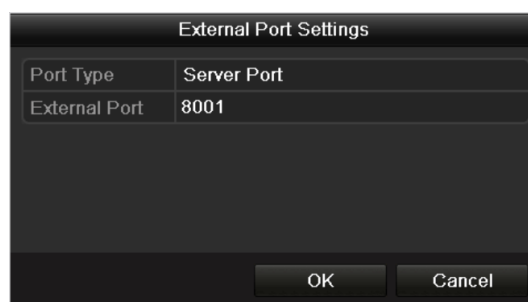

Figure 9.27 External Port Settings Dialog Box

- 3) Click **Apply** button to save the settings.
- 4) You can click **Refresh** button to get the latest status of the port mapping.

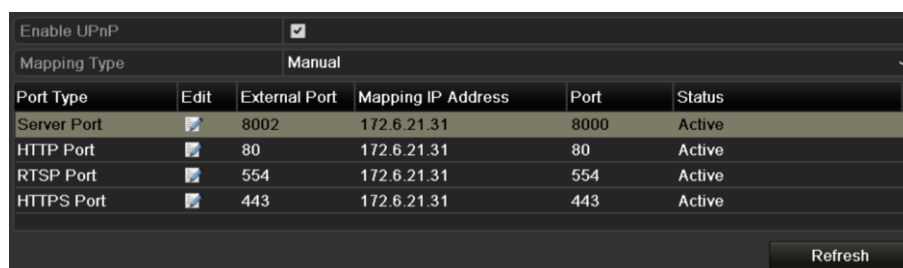

Figure 9.28 UPnP™ Settings Finished-Manual

● Manual Mapping

If your router does not support the UPnP™ function, perform the following steps to map the port manually in an easy way.

Before you start:

Make sure the router support the configuration of internal port and external port in the interface of Forwarding.

Steps:

1. Enter the Network Settings interface.
Menu > Configuration > Network
2. Select the **NAT** tab to enter the port mapping interface.
3. Leave the Enable UPnP checkbox unchecked.
4. Click to activate the External Port Settings dialog box. Configure the external port No. for server port, http port, RTSP port and https port respectively.



The value of the RTSP port No. should be 554 or between 1024 and 65535, while the value of the other ports should be between 1 and 65535 and the value must be different from each other. If multiple devices are configured for the UPnP™ settings under the same router, the value of the port No. for each device should be unique.

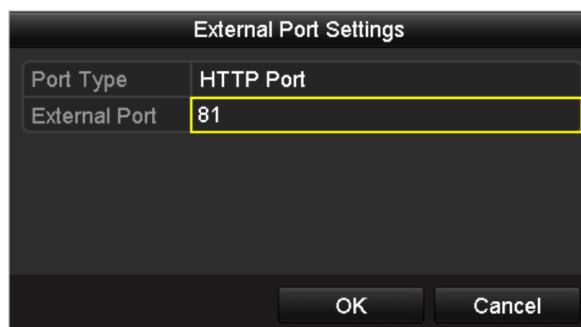

Figure 9. 29 External Port Settings Dialog Box

5. Click **OK** to save the setting for the current port and return to the upper-level menu.
6. Click **Apply** button to save the settings.
7. Enter the virtual server setting page of router; fill in the blank of Internal Source Port with the internal port value, the blank of External Source Port with the external port value, and other required contents.



Each item should be corresponding with the device port, including server port, http port, RTSP port and https port.

Delete	External Source Port	Protocol	Internal Source IP	Internal Source Port	Application
<input type="checkbox"/>	81	TCP	192.168.251.101	80	HTTP

Figure 9. 30 Setting Virtual Server Item



The above virtual server setting interface is for reference only, it may be different due to different router manufactures. Please contact the manufacture of router if you have any problems with setting virtual server.

9.2.12 Configuring High-speed Download

Purpose:

You can enable the High-speed Download function to widen the outgoing bandwidth of the device. In this way you can speed up the download of record files through web browser or CMS software.



If you enable the high-speed download function, the outgoing bandwidth of the device will be increased by 40Mbps and the local menu operation will be affected. It is recommended to disable this function after finishing the remote downloading of record files.

Steps:

1. Enter the Network Settings interface.
Menu >Configuration> Network
2. Select the **More Settings** tab to enter the More Settings interface, as shown in Figure 9. 15.

3. Check the checkbox of **Enable High-speed Download**. And click the **OK** button in the pop-up message box to confirm the settings.



Figure 9. 31 High-speed Download Settings Menu

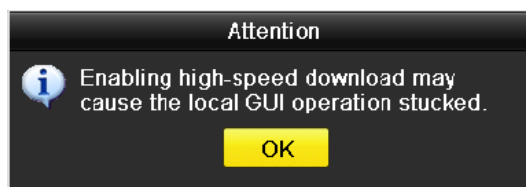

Figure 9. 32 Message Box of High-speed Download

4. Click **Apply** button to save and exit the interface.

9.2.13 Configuring Virtual Host

Purpose:

You can directly get access to the IP camera management interface after enabling this function.



The Virtual host function can be only configured through the web browser.

Steps:

1. Enter the Advanced settings interface, as shown in the Figure 9. 33.
Configuration > Remote Configuration > Network Settings > Advanced

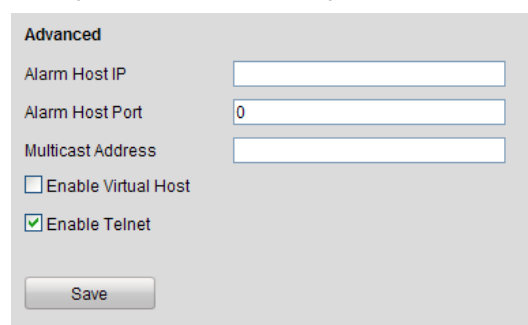

Figure 9. 33 Advanced Settings Interface

2. Check the checkbox of the **Enable Virtual Host**.
3. Click the **Save** button to save the setting.
4. Enter the IP camera management interface of NVR. The Connect column appears on the right-most side of the camera list, as shown in the Figure 9. 34.
Configuration > Remote Configuration > Camera Management > IP Camera

Channel No.	IP Camera Address	Channel No.	Management Port	Status	Protocol	Connect
<input type="checkbox"/> D01	172.6.22.84	1	80	Online	ONVIF	http://172.6.22.84:80
<input type="checkbox"/> D02	172.6.23.123	1	8000	Offline(Network Abnormal)	HIKVISION	http://172.6.23.123:80
<input type="checkbox"/> D03	172.6.10.13	1	8000	Online	HIKVISION	http://172.6.10.13:80
<input type="checkbox"/> D04	172.6.23.2	1	8000	Online	HIKVISION	http://172.6.23.2:80

Figure 9. 34 Connect to IP Camera

5. Click the link and the page of IP camera management appears.

9.2.14 Configuring Telnet

Purpose:

Telnet function provides an easy way to get access to the NVR. You can see the advanced information about the device by inputting command; as well the configuration can also be realized through telnet connection.

Steps:

1. Enter the Advanced settings interface, as shown in the Figure 9. 33.
Configuration > Remote Configuration > Network Settings > Advanced
2. Check the checkbox of the **Enable Telnet**.
3. Click the **Save** button to save the setting.
4. You can open the Command Prompt window in your PC, and input “telnet *IP Address*” to connect with the NVR, as shown in the figure below.

Example:

If the IP address of the NVR is 192.0.0.64, you can input “telnet 192.0.0.64” and then press Enter to connect to the NVR.

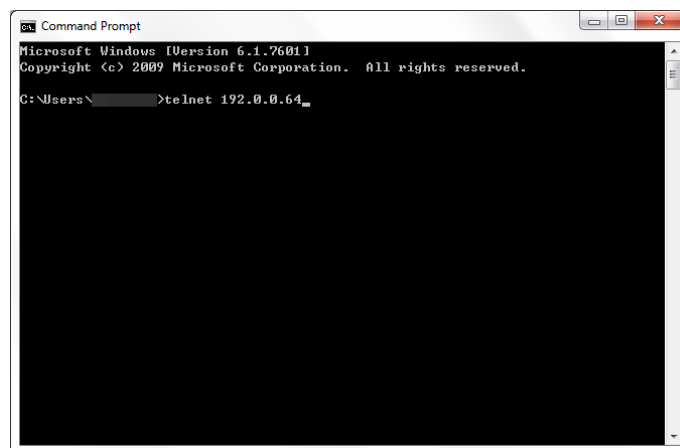

Figure 9. 35 Connect to NVR



The telnet function turns invalid after the device shutting down or rebooting, you have to enable it again if required.

9.3 Checking Network Traffic

Purpose:

You can check the network traffic to obtain real-time information of NVR such as linking status, MTU, sending/receiving rate, etc.

Steps:

1. Enter the Network Traffic interface.

Menu > Maintenance > Net Detect



Figure 9. 36 Network Traffic Interface

2. You can view the sending rate and receiving rate information on the interface. The traffic data is refreshed every 1 second.

9.4 Configuring Network Detection

Purpose:

You can obtain network connecting status of NVR through the network detection function, including network delay, packet loss, etc.

9.4.1 Testing Network Delay and Packet Loss

Steps:

1. Enter the Network Traffic interface.
Menu >Maintenance>Net Detect
2. Click the **Network Detection** tab to enter the Network Detection menu, as shown in Figure 9. 37.

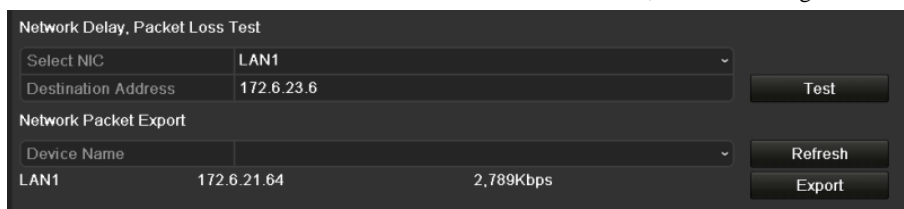

Figure 9. 37 Network Detection Interface

3. Enter the destination address in the text field of **Destination Address**.
4. Click **Test** button to start testing network delay and packet loss. The testing result pops up on the window. If the testing is failed, the error message box will pop up as well. Refer to Figure 9. 38.

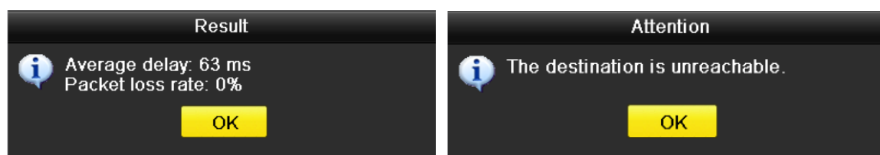

Figure 9. 38 Testing Result of Network Delay and Packet Loss

9.4.2 Exporting Network Packet

Purpose:

By connecting the NVR to network, the captured network data packet can be exported to USB-flash disk, SATA/eSATA, DVD-R/W and other local backup devices.

Steps:

1. Enter the Network Traffic interface.
Menu >Maintenance>Net Detect
2. Click the **Network Detection** tab to enter the Network Detection interface.
3. Select the backup device from the dropdown list of Device Name, as shown in Figure 9. 39.



Click **Refresh** button if the connected local backup device cannot be displayed. When it fails to detect the backup device, please check whether it is compatible with the NVR. You can format the backup device if the format is incorrect.

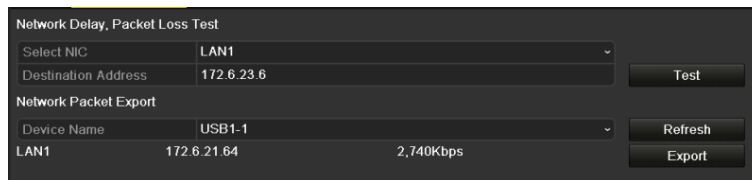

Figure 9. 39 Export Network Packet

4. Click **Export** button to start exporting.
5. After the exporting is complete, click **OK** to finish the packet export, as shown in Figure 9. 40.

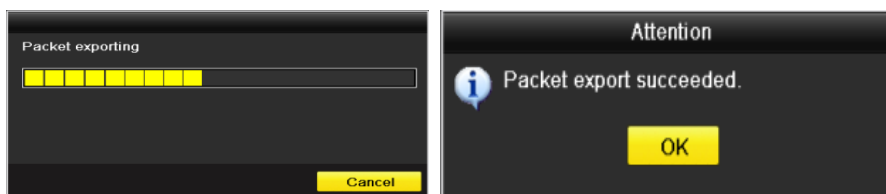

Figure 9. 40 Packet Export Attention



Up to 1M data can be exported each time.

9.4.3 Checking the Network Status

Purpose:

You can also check the network status and quick set the network parameters in this interface.

Steps:

Click the **Status** button on the lower- right corner of the page.

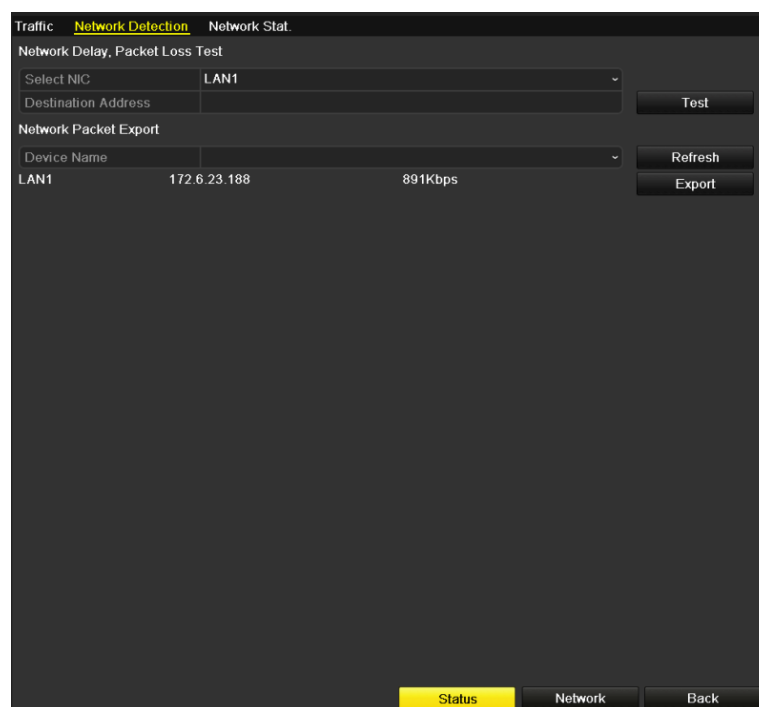

Figure 9. 41 Network Status Checking

If the network is normal the following message box pops out.

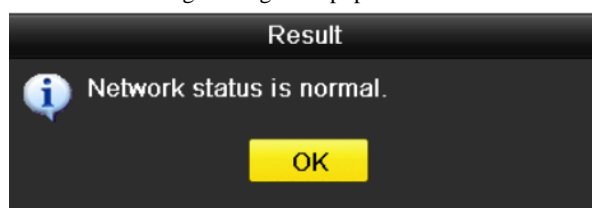

Figure 9. 42 Network Status Checking Result

If the message box pops out with other information instead of this one, you can click **Network** button to show the quick setting interface of the network parameters.

9.4.4 Checking Network Statistics

Purpose:

You can check the network status to obtain the real-time information of NVR.

Steps:

1. Enter the Network Detection interface.
Menu>Maintenance>Net Detect
2. Choose the **Network Stat.** tab.

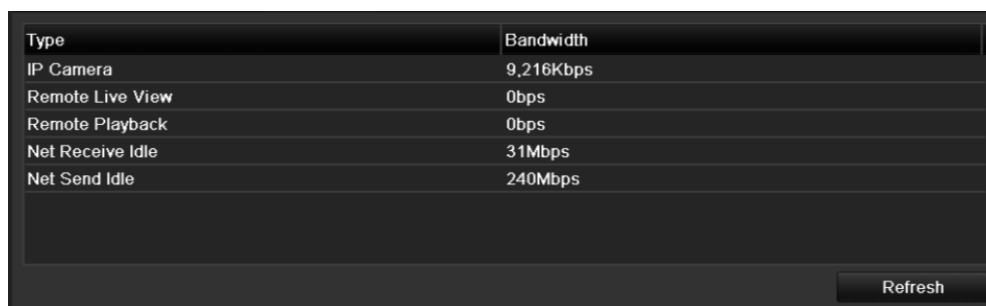

Type	Bandwidth
IP Camera	9,216Kbps
Remote Live View	0bps
Remote Playback	0bps
Net Receive Idle	31Mbps
Net Send Idle	240Mbps

Refresh

Figure 9. 43 Network Stat. Interface

3. Check the bandwidth of IP Camera, bandwidth of Remote Live View, bandwidth of Remote Playback, bandwidth of Net Receive Idle and bandwidth of Net Send Idle.
4. You can click **Refresh** to get the newest status.

Chapter 10 RAID (Only for DS-9600NI-RT series NVR)



This chapter is applicable for DS-9600NI-RT series only.

10.1 Configuring Array and Virtual Disk

Purpose:

RAID (redundant array of independent disks) is a storage technology that combines multiple disk drive components into a logical unit. A RAID setup stores data over multiple hard disk drives to provide enough redundancy so that data can be recovered if one disk fails. Data is distributed across the drives in one of several ways called "RAID levels", depending on what level of redundancy and performance is required. The DS-9600NI-RT is capable of realizing Redundant Array of Independent Disk, supporting RAID0, RAID1, RAID5 and RAID10.

Before you start:

Please install the HDD(s) properly and it is recommended to use the same enterprise-level HDDs (including model and capacity) for array creation and configuration so as to maintain reliable and stable running of the disks.

Introduction:

The DS-9600NI-RT series can store the data (such as record, picture, log information) in the HDD only after you have created the virtual disk or you have configured network HDD (refer to *Chapter 12.2 Managing Network HDD*). Our device provides two ways for creating the virtual disk, including one-touch configuration and manual configuration. The following flow chart shows the process of creating virtual disk.

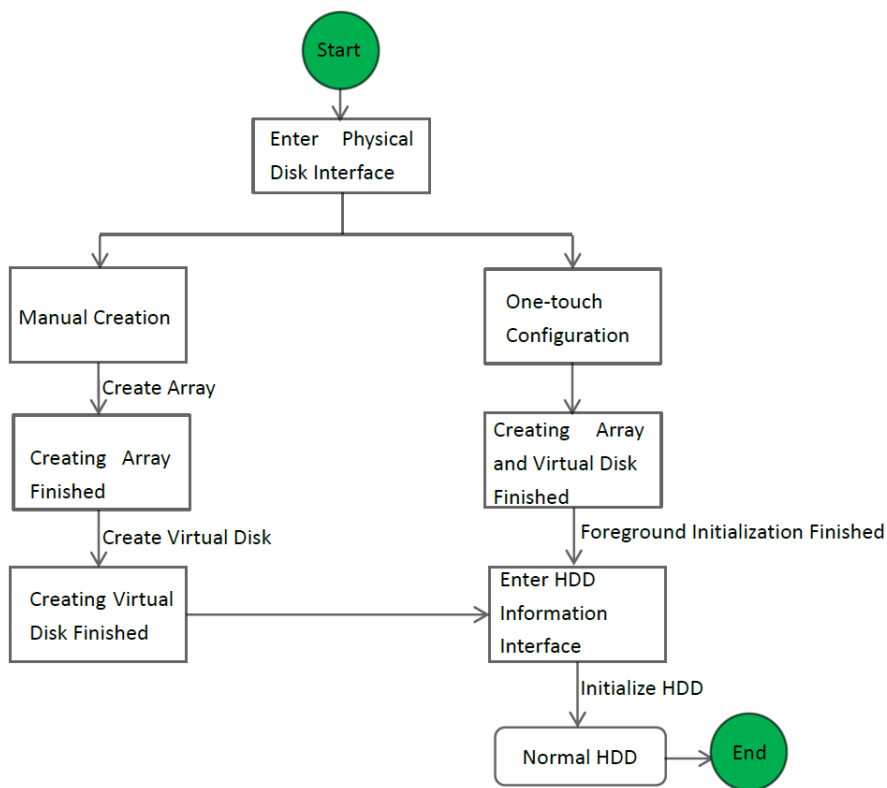

Figure 10. 1 RAID Working Flow

10.1.1 One-touch Configuration

Purpose:

Through one-touch configuration, you can quickly create the disk array and virtual disk. By default, the array type to be created is RAID 5.

Steps:

1. Enter the Physical Disk Settings interface.

Menu > HDD > RAID > Physical Disk

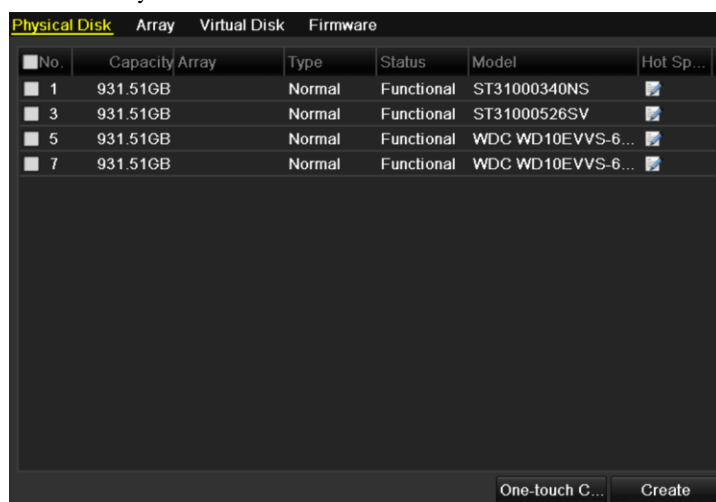

Figure 10.2 Physical Disk Settings Interface

2. Click **One-touch Configuration** button to enter the One-touch Array Configuration interface.



As the default array type is RAID 5, at least 3 HDDs must be installed in you device.

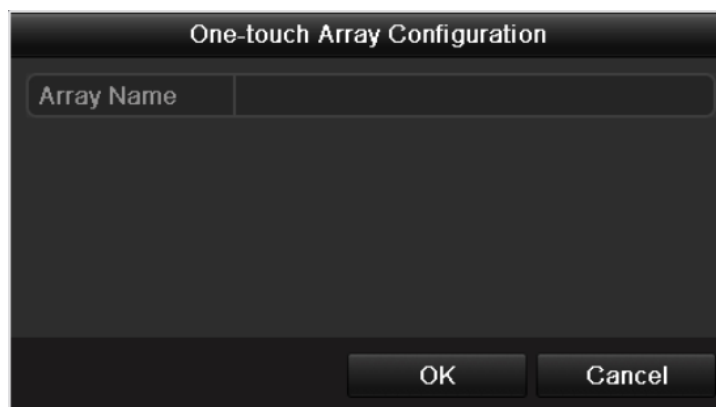

Figure 10.3 One-touch Array Configuration

3. Edit the array name in the **Array Name** text filed and click **OK** button to start configuring array.



If you install 4 HDDs or above for one-touch configuration, a hot spare disk will be set by default. It is recommended to set hot spare disk for automatically rebuilding the array when the array is abnormal.

4. When the array configuration is completed, click **OK** button in the pop-up message box to finish the settings.

5. You can click **Array** tab to view the information of the successfully created array.



By default, one-touch configuration creates an array and a virtual disk.

Physical Disk Array Virtual Disk Firmware									
No.	Name	Free Space	Physic...	Hot ...	Status	Level	Re...	Del...	Task
1	RAID_1	0/1862G	3 4 5		Functional RAID 5				None

Figure 10.4 Array Settings Interface

6. Click Virtual Disk tab to view the automatically created virtual disk.



By default, one-touch configuration adopts background initialization to initialize the virtual disk, thus the virtual disk can be used immediately.

Physical Disk Array Virtual Disk Firmware								
No.	Name	Cap...	Array	Status	Type	Repair	Delete	Task
1	vd1_RAID	1862G	RAID_1	Funcio...	RAID 5	—		Initialize (Background)

Figure 10.5 Virtual Disk Settings Interface

7. You can see the information of the logical disk in the HDD Information interface.



For configuring hot spare disk manually, please refer to steps 12-15 of *Chapter 10.1.2*.

10.1.2 Manually Creating Array and Virtual Disk

Purpose:

You can manually create the array of RAID 0, RAID 1, RAID 5 and RAID 10.



In this section, we take RAID 5 as an example to describe the manual configuration of array and virtual disk.

Steps:

1. Enter the Physical Disk Settings interface.

Menu > HDD > RAID > Physical Disk

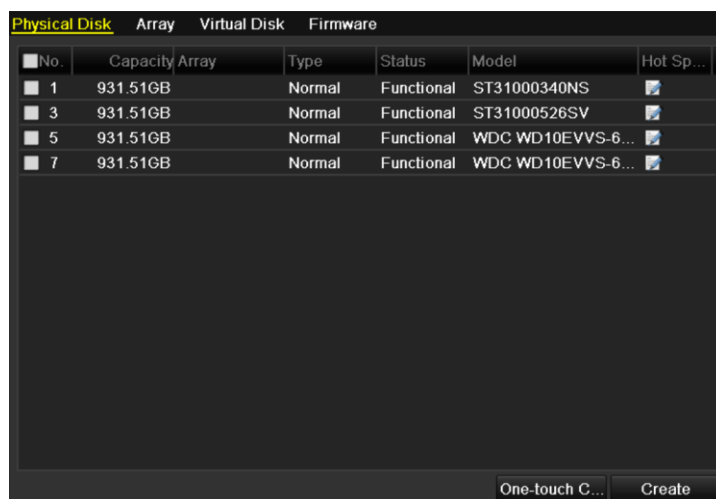

Figure 10.6 Physical Disk Settings Interface

2. Click **Creat** button to enter the Create Array interface.

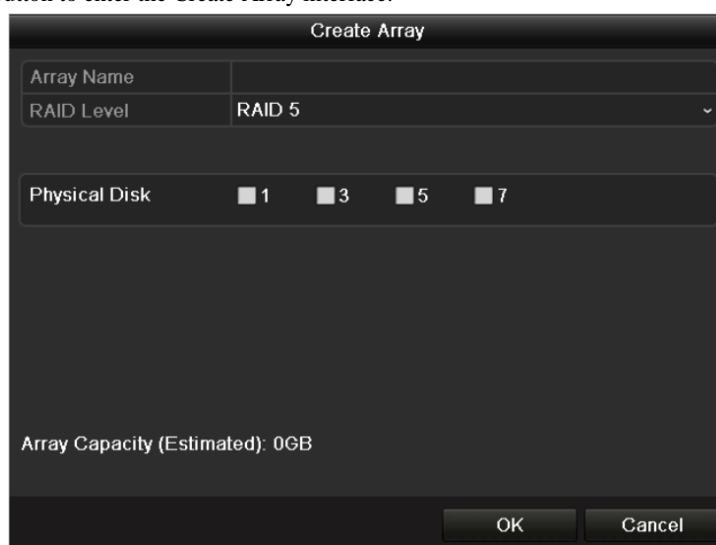

Figure 10.7 Create Array Interface

3. Edit the **Array Name**; set the **RAID Level** to RAID 0, RAID 1, RAID 5 or RAID 10; select the **Physical Disk** that you want to configure array.



- If you choose RAID 0, at least 2 HDDs must be installed.
- If you choose RAID 1, 2 HDDs need to be configured for RAID 1.
- If you choose RAID 5, at least 3 HDDs must be installed.
- If you choose RAID 10, 4/6/8 HDDs need to be configured for RAID 10.

4. Click **OK** button to create array.



If the number of HDDs you select is not compatible with the requirement of the RAID level, the error message box will pop up.



Figure 10. 8 Error Message Box

5. You can click **Array** tab to view the successfully created array.

Physical Disk <u>Array</u> Virtual Disk Firmware									
No.	Name	Free Space	Physic...	Hot ...	Status	Level	Re...	Del...	Task
1	Array01	1862/186...	3 4 5		Functi...	RAID 5			None

Figure 10. 9 Array Settings Interface

6. Click to select an array and click **Creat Vd** button to enter the Create Virtual Disk interface.



The device supports creating at most 8 virtual disks.

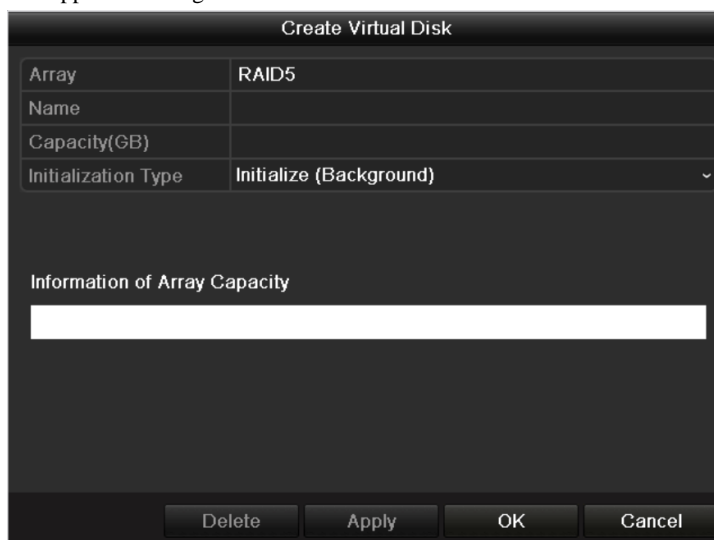

Figure 10. 10 Create Virtual Disk Interface

7. Edit the name of the virtual disk, set the capacity for the virtual disk and select the initialization type for the virtual disk.



- You can also click the **Information of Array Capacity** area to set the remaining capacity of the array for the disk.
- It is recommended to create one virtual disk of an array.
- At least 100GB capacity must be configured for each virtual disk.
- There are three initialization types, including Background, Foreground and Fast.

Fast (Not Recommended): The fast initialization usually takes short time and only initializes part of the data of the virtual disk, and cannot detect the bad sector.

Foreground (Recommended): By using foreground initialization, the virtual disk will be initialized totally and the bad sector of the hard disks can be detected and repaired. The virtual disk can be used only after the initialization is complete.

Background: The background initialization can synchronize the disks, and detect and repair the bad sector of the disks. During the background initialization, the virtual disk is allowed to be used.

8. Click **Apply** button to save the settings and click **OK** button to return to Array Settings interface
9. Click Virtual Disk tab to enter the Virtual Disk interface. The successfully created virtual disk will be listed on the interface.

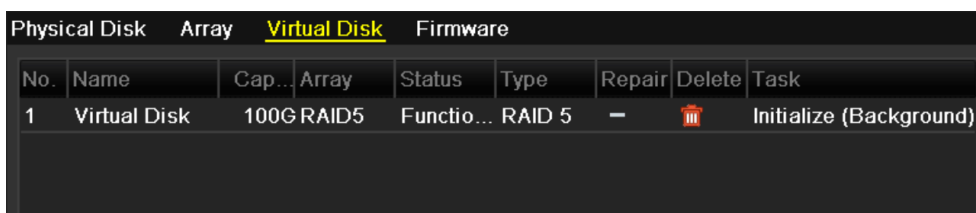

Figure 10. 11 Virtual Disk Interface

10. Enter the HDD Information interface (Menu>HDD>General) and the virtual disk will display. For operation guide of initializing the virtual disk, please refer to *Chapter 11.1 Initializing HDDs*.



- If you adopt foreground initialization, the virtual disk will display in the HDD Information interface after the initialization is complete.
- The HDD will be automatically initialized if you adopt the background or fast initialization to the virtual disk.

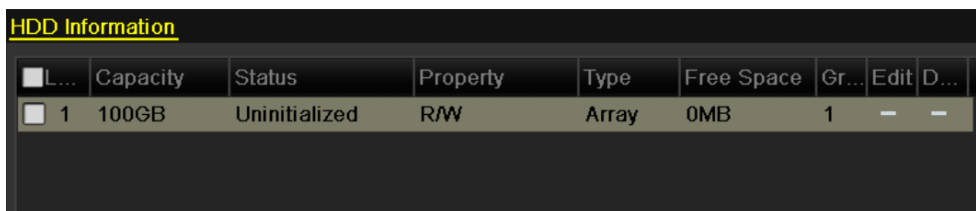

Figure 10. 12 HDD Information Interface

11. After the virtual disk has been initialized, the status will change to *Normal*.

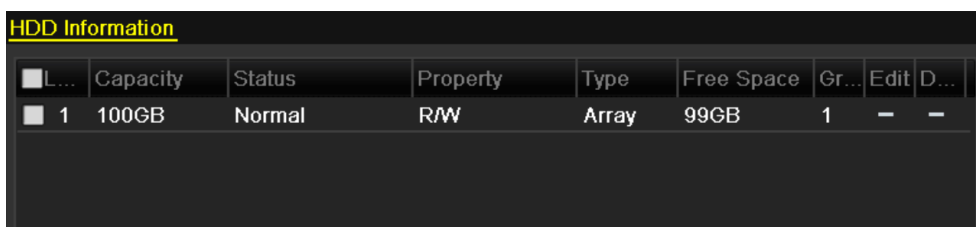

Figure 10. 13 Initialization Finished

12. Enter the Physical Disk Settings interface to configure the hot spare disk.

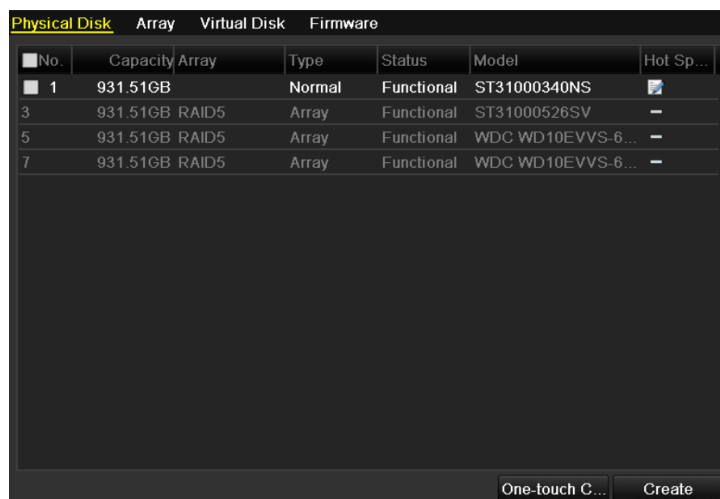

Figure 10. 14 Physical Disk Settings Interface

13. Select a disk and click to set it as a global hot spare disk, which can be used as the hot spare for any array created in the system.



The hot spare disk will be automatically used for array rebuilding if the virtual disk is in **Degraded** status.

10.2 Rebuilding Array

Purpose:

The working status of array includes Functional, Disk Loss and Offline. By viewing the array status, you can take immediate and proper maintenance for the disks so as to ensure the high security and reliability of the data stored in the disk array.

When there is no disk loss in the array, the working status of array remains Functional; when the number of lost disks has exceeded the limit, the working status of array changes to Offline; in other conditions, the working status is Disk Loss.

When the virtual disk is in Degraded status, you can restore it to Functional by array rebuilding.

10.2.1 Automatically Rebuilding Array

Purpose:

When the virtual disk is in Degraded status, the device can start rebuilding the array automatically with the hot spare disk to ensure the high security and reliability of the data.

Before you start:

Since the *Auto-rebuild* function is enabled by default, the hot spare disk must be configured.

Steps:

1. Enter the Array Settings interface. The status of the array is Disk Loss. Since the hot spare disk is configured and *Auto-rebuild* function is enabled. The hot spare disk will be automatically used for array rebuilding.

Menu > HDD > RAID > Array

No.	Name	Free Space	Physic...	Hot ...	Status	Level	Re...	Del...	Task
1	array	831/931G	7 3 6		Disk L...	RAID 5			Rebuild(Running)

Figure 10. 15 Array Settings Interface

2. Enter the Virtual Disk interface to view the rebuilding status of the virtual disk.

Menu>HDD>RAID>Virtual Disk

No.	Name	Cap...	Array	Status	Type	Repair	Delete	Task
1	vd	100G	array	Degrad...	RAID 5	-		Rebuild(Running) 8%

Figure 10. 16 Virtual Disk Settings Interface



If there is no hot spare disk after rebuilding, it is recommended to install a HDD into the device and set it as a hot spare disk to ensure the high security and reliability of the array. For detailed operation guide, please refer to steps 12-15 of *Chapter 10.1.2*

10.2.2 Manually Rebuilding Array

Purpose:

If you do not enable the Auto-rebuild in Firmware Settings interface (Menu>HDD>RAID>Firmware) or the hot spare disk has not been configured, then you can rebuild the array manually to restore the array when the virtual disk is in Degraded status.

Steps:

1. Enter the Array Settings interface. The disk 3 is lost.

Menu > HDD > RAID > Array

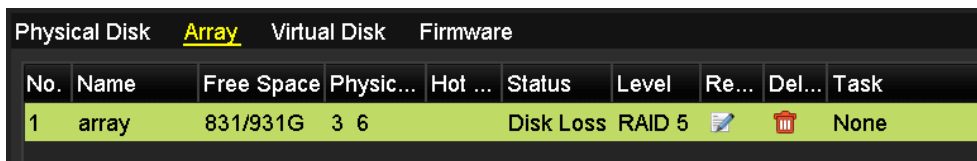

Figure 10.17 Array Settings Interface

2. Enter the Virtual Disk interface to check the status of the virtual disk. The virtual disk is in Degraded status.

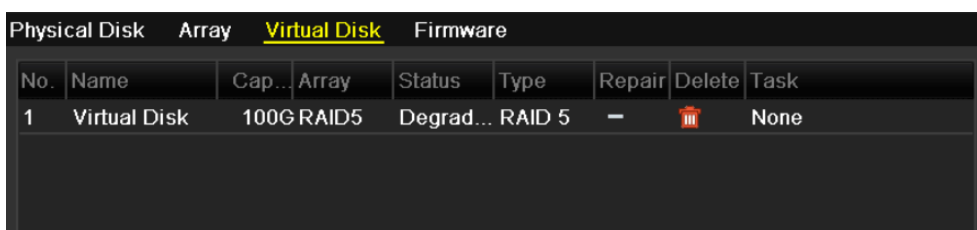

Figure 10.18 Virtual Disk Interface

3. Click Array tab to back to the Array Settings interface and click to configure the array rebuild.



At least one available physical disk should exist for rebuilding the array.

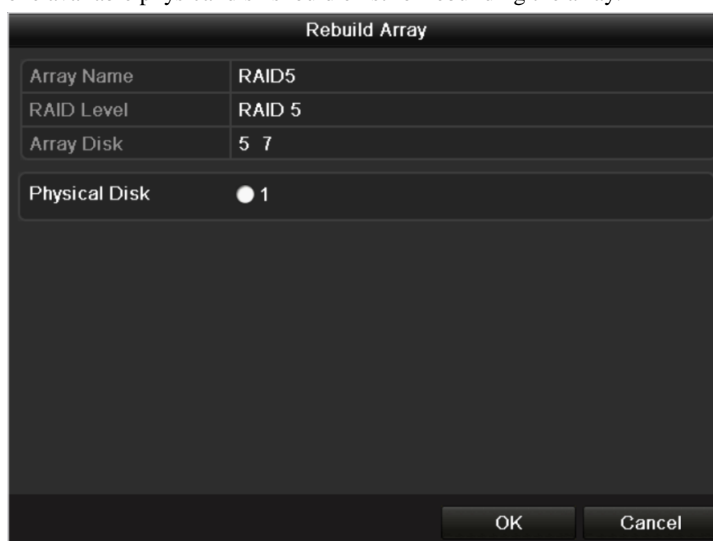

Figure 10.19 Rebuild Array Interface

4. Select the available physical disk and click **OK** button to confirm to rebuild the array.

5. The “Do not unplug the physical disk when it is under rebuilding” message box pops up. Click **OK** button to start rebuilding.
6. You can enter the Array Settings interface and Virtual Disk interface to view the rebuilding status.
7. After rebuilding successfully, the array and virtual disk will restore to Functional.



It is recommended to enable the *Auto-rebuild* function and set the hot spare disk for automatically rebuilding the array.

10.3 Repairing Virtual Disk

Purpose:

When the disk cannot display in the HDD Information interface while the virtual disk can still show in the Array Settings interface, you have to repair the virtual disk.



If the virtual disk is under foreground initialization, the repairing cannot be done.

Steps:

1. Enter the Virtual Disk interface.

Menu > HDD > RAID > Virtual Disk

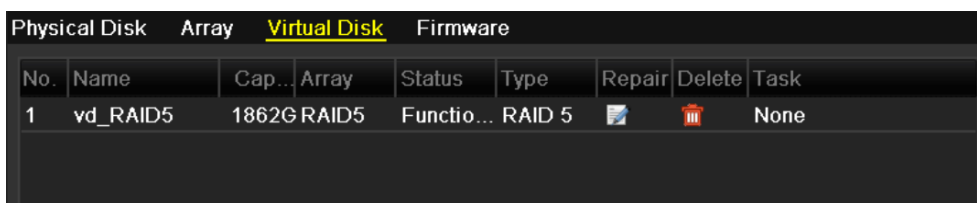

Figure 10. 20 Virtual Disk Interface

2. Click to repair the virtual disk. After successfully repairing, the following message box will pop up. Click **OK** button to finish the settings.



Figure 10. 21 Repairing Virtual Disk Successfully

The disk shows again in the HDD Information interface (Menu>HDD>General).

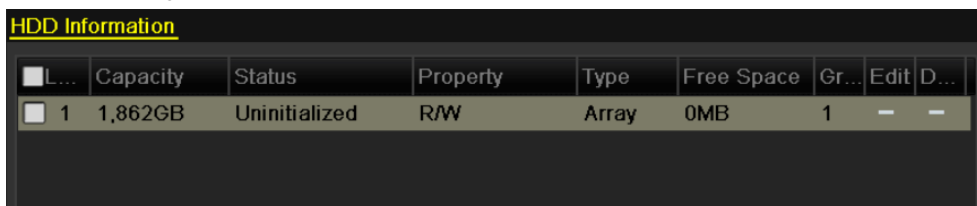

Figure 10. 22 HDD Information Interface

10.4 Deleting Array / Virtual Disk



Before deleting the array, the virtual disk(s) existing under this array must be deleted first. Deleting array and virtual disk will cause to delete all the data saved in the disk.

10.4.1 Deleting the Virtual Disk

Steps:

1. Enter the Virtual Disk interface.
Menu>HDD>RAID>Virtual Disk

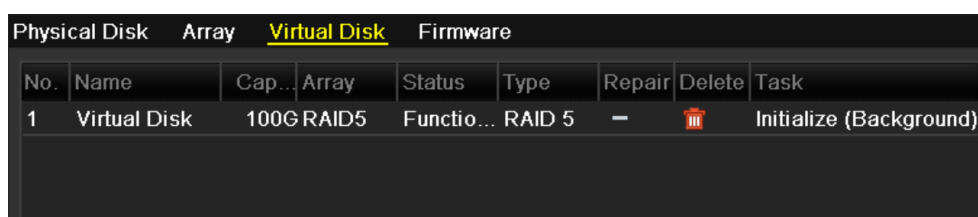

Figure 10. 23 Virtual Disk Interface

2. Select a virtual disk and click to delete the virtual disk.



Figure 10. 24 Confirm Virtual Disk Deletion

3. In the pop-up message box, click **Yes** button to confirm the virtual disk deletion.



Deleting virtual disk will cause to delete all the data saved in the disk.

10.4.2 Deleting the Array



If all the virtual disks existing under an array have been deleted, then you can delete that array.

Steps:

1. Enter the Array Settings interface.

Menu>HDD>RAID>Array



Figure 10. 25 Array Settings Interface

2. Select an array and click  to delete the array.



Figure 10. 26 Confirm Array Deletion

3. In the pop-up message box, click **Yes** button to confirm the array deletion.



Deleting array will cause to delete all the data in the array.

10.5 Upgrading Firmware

Purpose:

You can view the information of the firmware and upgrade the firmware by local backup device or remote FTP server.

Steps:

1. Enter the Firmware interface to check the information of the firmware, including the version, maximum physical disk quantity, maximum array quantity, auto-rebuild status, etc.

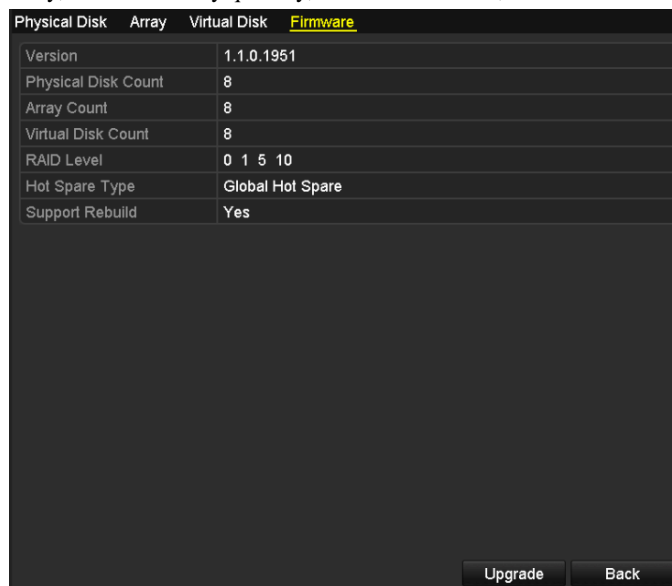

Physical Disk	Array	Virtual Disk	Firmware
Version	1.1.0.1951		
Physical Disk Count	8		
Array Count	8		
Virtual Disk Count	8		
RAID Level	0 1 5 10		
Hot Spare Type	Global Hot Spare		
Support Rebuild	Yes		

Upgrade Back

Figure 10.27 Firmware Interface

2. You can click **Upgrade** button to upgrade the firmware. Local upgrade and FTP upgrade are available. Since the upgrading process of the firmware is the same as that of the device firmware, you can refer to *Chapter 13.4* for detailed information.



Please contact the dealer immediately if the device cannot work properly after upgrading.

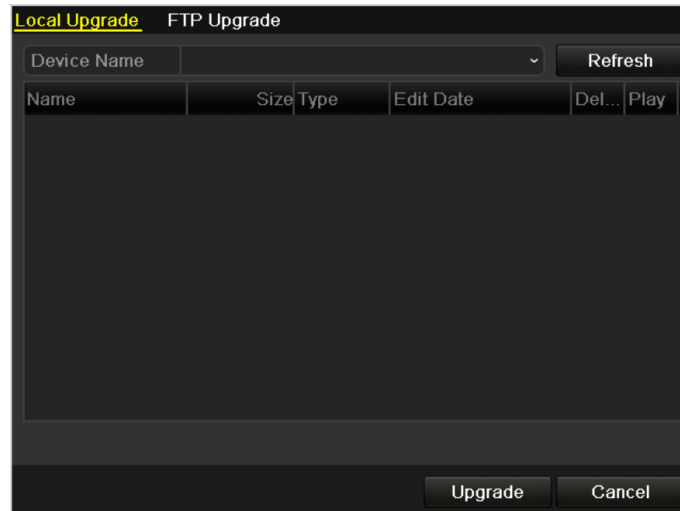

Figure 10. 28 Upgrade the Firmware

Chapter 11 RAID (Only for DS-9600NI-ST&XT and DS-8600NI-ST series NVR)

11.1 Configuring Array

Purpose:

RAID (redundant array of independent disks) is a storage technology that combines multiple disk drive components into a logical unit. A RAID setup stores data over multiple hard disk drives to provide enough redundancy so that data can be recovered if one disk fails. Data is distributed across the drives in one of several ways called "RAID levels", depending on what level of redundancy and performance is required.

The DS-9600NI-ST&XT and DS-8600NI-ST series NVR support the disk array which is realized by the software, and RAID0, RAID1, RAID5 and RAID 10 are supported. You can enable the RAID function on your demand.

Before you start:

Please install the HDD(s) properly and it is recommended to use the same enterprise-level HDDs (including model and capacity) for array creation and configuration so as to maintain reliable and stable running of the disks.

Introduction:

The DS-9600NI-ST&XT and DS-8600NI-ST series can store the data (such as record, picture, log information) in the HDD only after you have created the array or you have configured network HDD (refer to *Chapter12.2 Managing Network HDD*). Our device provides two ways for creating array, including one-touch configuration and manual configuration. The following flow chart shows the process of creating array.

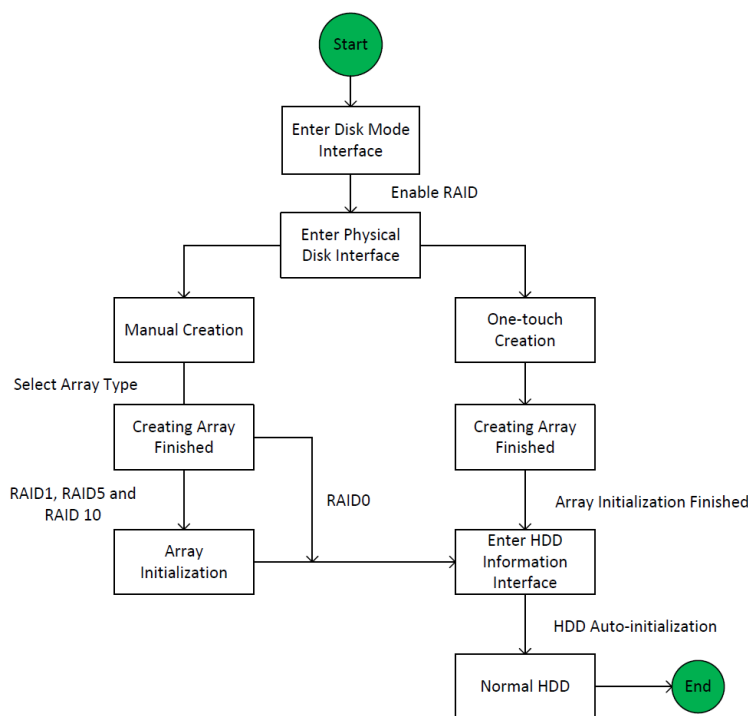

Figure 11. 1 RAID Working Flow

11.1.1 Enable RAID

Purpose:

Perform the following steps to enable the RAID function, or the disk array cannot be created.

- **OPTION 1:**

Enable the RAID function in the Wizard when the device startup, please refer to step 7 of Chapter 2.2.

- **OPTION 2:**

Enable the RAID function in the HDD Management Interface.

Steps:

1. Enter the disk mode configuration interface.

Menu > HDD > Advanced

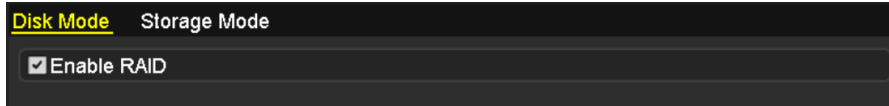

Figure 11. 2 Enable RAID Interface

2. Check the checkbox of **Enable RAID**.

3. Click the **Apply** button to save the settings.

11.1.2 One-touch Configuration

Purpose:

Through one-touch configuration, you can quickly create the disk array. By default, the array type to be created is RAID 5.

Before you start:

1. The RAID function should be enabled, please refer to the Chapter 11.1.1 for details.
2. As the default array type is RAID 5, please install at least 3 HDDs in you device.

Steps:

1. Enter the RAID configuration interface.

Menu > HDD > RAID

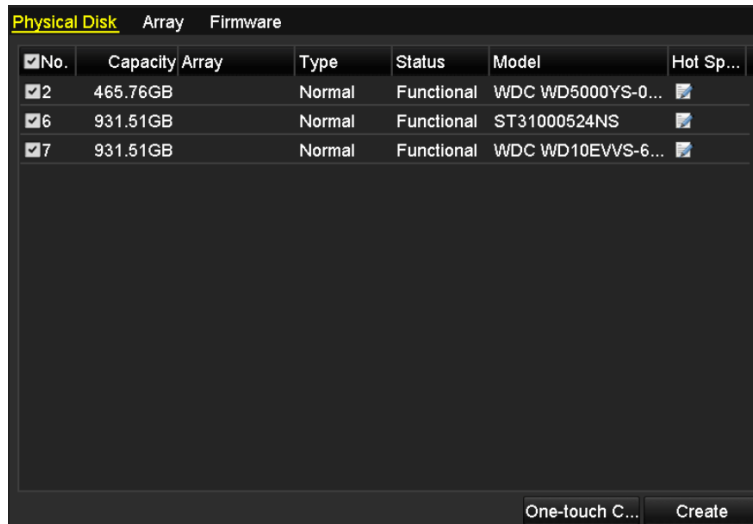

Figure 11. 3 Physical Disk Interface

2. Check the checkbox of corresponding HDD No. to select it.

3. Click the **One-touch Create** button to enter the One-touch Array Configuration interface.

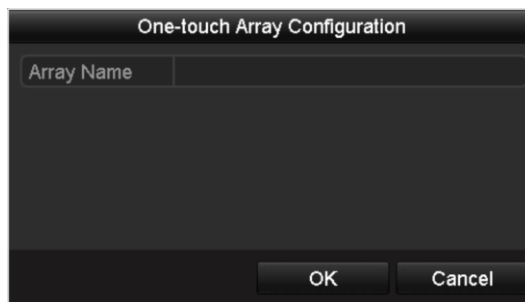

Figure 11. 4 One-touch Array Configuration

4. Edit the array name in the **Array Name** text field and click **OK** button to start configuring array.



If you install 4 HDDs or above for one-touch configuration, a hot spare disk will be set by default. It is recommended to set hot spare disk for automatically rebuilding the array when the array is abnormal.

5. When the array configuration is completed, click **OK** button in the pop-up message box to finish the settings.
6. You can click **Array** tab to view the information of the successfully created array.



By default, one-touch configuration creates an array and a virtual disk.

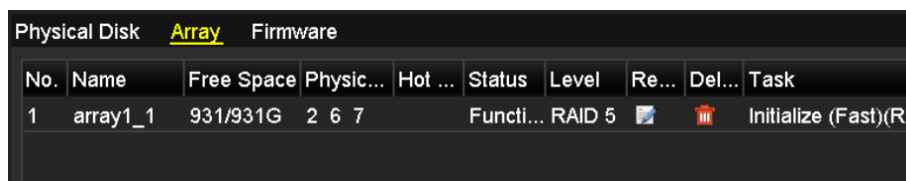

Figure 11. 5 Array Settings Interface

7. A created array displays as an HDD in the HDD information interface.

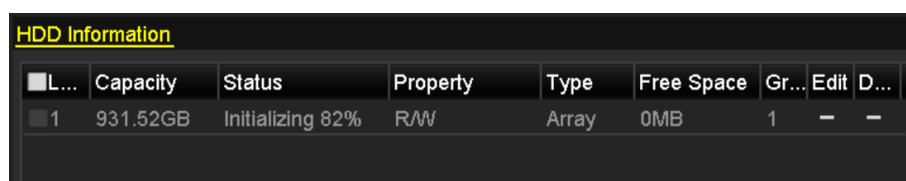

Figure 11. 6 HDD Information Interface

11.1.3 Manually Creating Array

Purpose:

You can manually create the array of RAID 0, RAID 1, RAID 5 and RAID 10.



In this section, we take RAID 5 as an example to describe the manual configuration of array and virtual disk.

Steps:

1. Enter the Physical Disk Settings interface.
Menu > HDD > RAID > Physical Disk

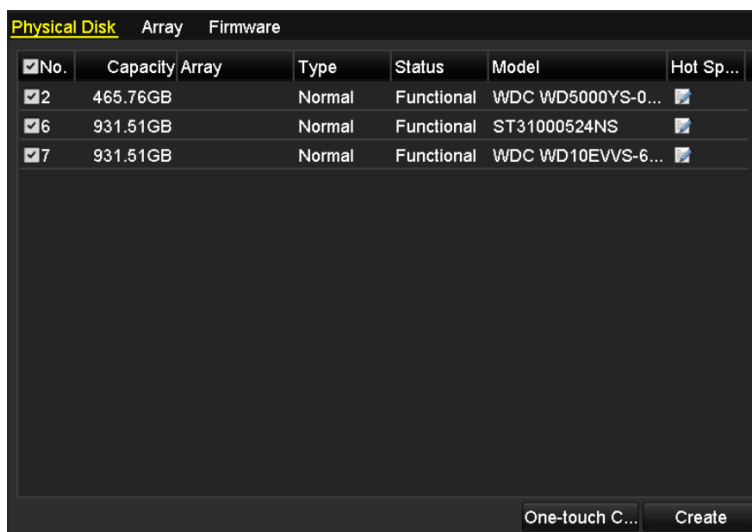

Figure 11. 7 Physical Disk Settings Interface

2. Click **Cre**at button to enter the Create Array interface.

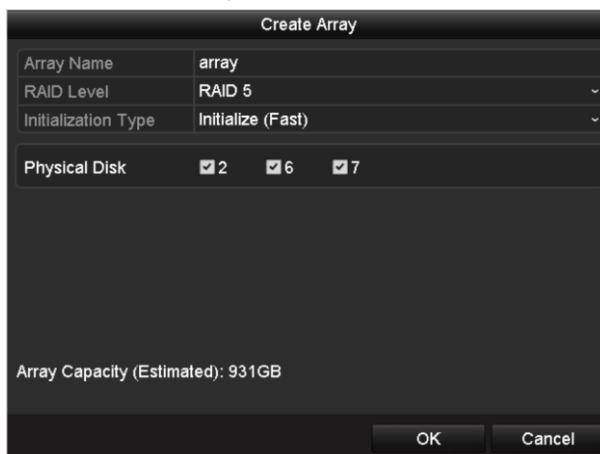

Figure 11. 8 Create Array Interface

3. Edit the **Array Name**; set the **RAID Level** to RAID 0, RAID 1, RAID 5 or RAID 10; select the **Physical Disk** that you want to configure array.



- If you choose RAID 0, at least 2 HDDs must be installed.
- If you choose RAID 1, 2 HDDs need to be configured for RAID 1.
- If you choose RAID 5, at least 3 HDDs must be installed.
- If you choose RAID 10, the number of HDDs installed should be even in the range of 4~16.

4. Click **OK** button to create array.



If the number of HDDs you select is not compatible with the requirement of the RAID level, the error

message box will pop up.



Figure 11.9 Error Message Box

5. You can click **Array** tab to view the successfully created array.



No.	Name	Free Space	Physic...	Hot ...	Status	Level	Re...	Del...	Task
1	array1_1	931/931G	2 6 7		Functi...	RAID 5			Initialize (Fast)(R)

Figure 11.10 Array Settings Interface

11.2 Rebuilding Array

Purpose:

The working status of array includes Functional, Degraded and Offline. By viewing the array status, you can take immediate and proper maintenance for the disks so as to ensure the high security and reliability of the data stored in the disk array.

When there is no disk loss in the array, the working status of array will change to Functional; when the number of lost disks has exceeded the limit, the working status of array will change to Offline; in other conditions, the working status is Degraded.

When the virtual disk is in Degraded status, you can restore it to Functional by array rebuilding.

Before you start:

Please make sure the hot spare disk is configured.

1. Enter the Physical Disk Settings interface to configure the hot spare disk.

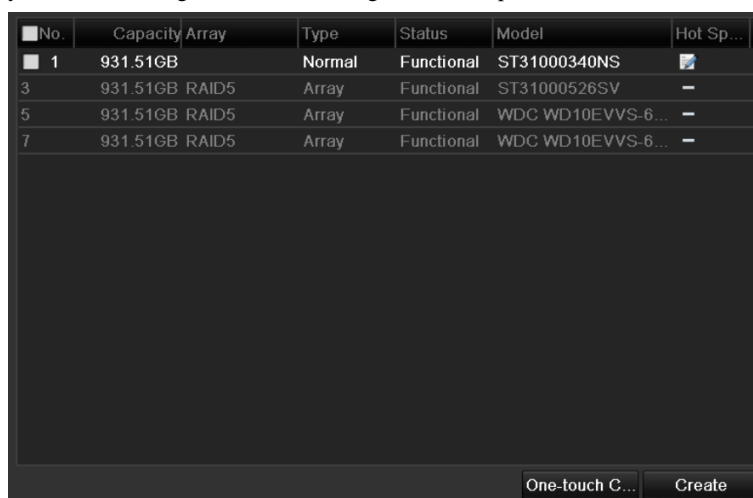

Figure 11.11 Physical Disk Settings Interface

2. Select a disk and click to set it as the hot spare disk.



Only global hot spare mode is supported.

11.2.1 Automatically Rebuilding Array

Purpose:

When the virtual disk is in Degraded status, the device can start rebuilding the array automatically with the hot spare disk to ensure the high security and reliability of the data.

Steps:

1. Enter the Array Settings interface. The status of the array is Degraded. Since the hot spare disk is configured, the system will automatically start rebuilding using it.

Menu > HDD > RAID > Array

No.	Name	Free Space	Physic...	Hot ...	Status	Level	Re...	Del...	Task
1	array1_1	931/931G	2 6 7		Degraded	RAID 5			Rebuild(Run)

Figure 11.12 Array Settings Interface

If there is no hot spare disk after rebuilding, it is recommended to install a HDD into the device and set it as a hot spare disk to ensure the high security and reliability of the array.

11.2.2 Manually Rebuilding Array

Purpose:

If you do not enable the Auto-rebuild in Firmware Settings interface (Menu>HDD>RAID>Firmware) or the hot spare disk has not been configured, then you can rebuild the array manually to restore the array when the virtual disk is in Degraded status.

Steps:

1. Enter the Array Settings interface. The disk 3 is lost.

Menu > HDD > RAID > Array

No.	Name	Free Space	Physic...	Hot ...	Status	Level	Re...	Del...	Task
1	array1_1	931/931G	2 6		Degraded	RAID 5			None

Figure 11.13 Array Settings Interface

2. Click Array tab to back to the Array Settings interface and click to configure the array rebuild.



At least one available physical disk should exist for rebuilding the array.

Rebuild Array	
Array Name	array1_1
RAID Level	RAID 5
Array Disk	2 6
Physical Disk	<input checked="" type="radio"/> 7
<input type="button" value="OK"/> <input type="button" value="Cancel"/>	

Figure 11.14 Rebuild Array Interface

3. Select the available physical disk and click **OK** button to confirm to rebuild the array.
4. The “Do not unplug the physical disk when it is under rebuilding” message box pops up. Click **OK** button to

start rebuilding.

5. You can enter the Array Settings interface to view the rebuilding status.
6. After rebuilding successfully, the array and virtual disk will restore to Functional.

11.3 Deleting Array



Deleting array will cause to delete all the data saved in the disk.

Steps:

1. Enter the Array Settings interface.

Menu>HDD>RAID>Array



Figure 11. 15 Array Settings Interface

2. Select an array and click  to delete the array.



Figure 11. 16 Confirm Array Deletion

3. In the pop-up message box, click **Yes** button to confirm the array deletion.



Deleting array will cause to delete all the data in the array.

11.4 Checking and Editing Firmware

Purpose:

You can view the information of the firmware and upgrade the firmware by local backup device or remote FTP server.

Steps:

1. Enter the Firmware interface to check the information of the firmware, including the version, maximum physical disk quantity, maximum array quantity, auto-rebuild status, etc.

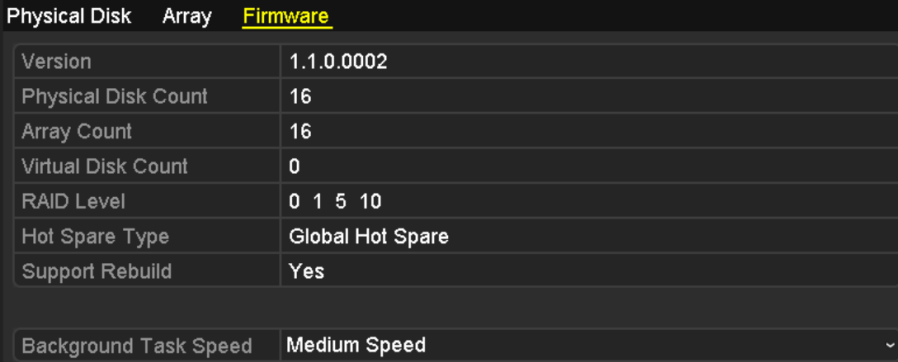

Physical Disk	Array	<u>Firmware</u>
Version		1.1.0.0002
Physical Disk Count		16
Array Count		16
Virtual Disk Count		0
RAID Level		0 1 5 10
Hot Spare Type		Global Hot Spare
Support Rebuild		Yes
Background Task Speed		Medium Speed ⌵

Figure 11.17 Firmware Interface

2. You can set the Background Task Speed in the drop-down list.

Chapter 12 HDD Management

12.1 Initializing HDDs

Purpose:

A newly installed hard disk drive (HDD) must be initialized before it can be used with your NVR.



A message box pops up when the NVR starts up if there exists any uninitialized HDD.

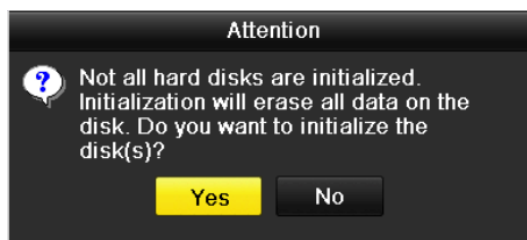

Figure 12.1 Message Box of Uninitialized HDD

Click **Yes** button to initialize it immediately or you can perform the following steps to initialize the HDD.

Steps:

1. Enter the HDD Information interface.

Menu > HDD > General

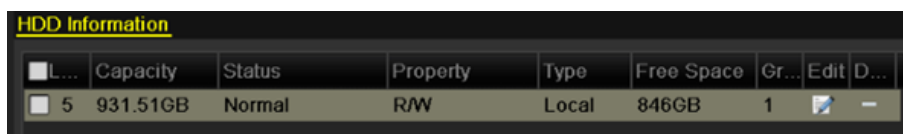

Figure 12.2 HDD Information Interface

2. Select HDD to be initialized.
3. Click the **Init** button.

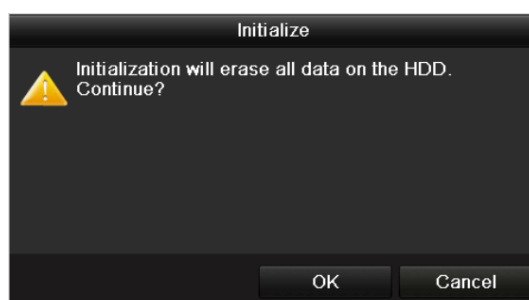

Figure 12.3 Confirm Initialization

4. Select the **OK** button to start initialization.

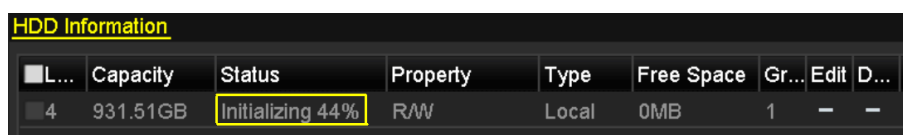
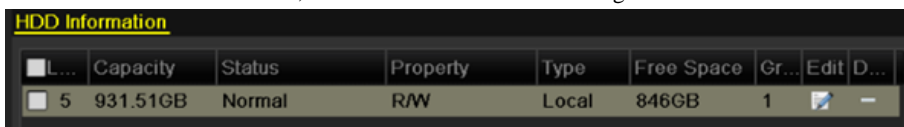

Figure 12.4 Status changes to Initializing

5. After the HDD has been initialized, the status of the HDD will change from *Uninitialized* to *Normal*.



The screenshot shows a table titled "HDD Information" with the following data:

L...	Capacity	Status	Property	Type	Free Space	Gr...	Edit	D...
5	931.51GB	Normal	R/W	Local	846GB	1		-

Figure 12. 5 HDD Status Changes to Normal



Initializing the HDD will erase all data on it.

12.2 Managing Network HDD

Purpose:

You can add the allocated NAS or disk of IP SAN to NVR, and use it as network HDD.

Steps:

1. Enter the HDD Information interface.

Menu > HDD>General

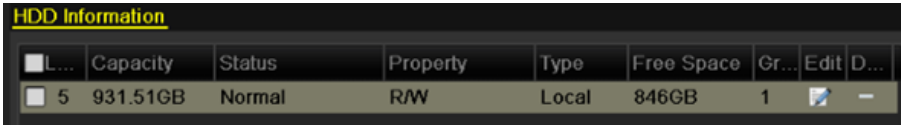

L...	Capacity	Status	Property	Type	Free Space	Gr...	Edit	D...
5	931.51GB	Normal	R/W	Local	846GB	1		-

Figure 12. 6 HDD Information Interface

2. Click the **Add** button to enter the Add NetHDD interface, as shown in Figure 12. 7.

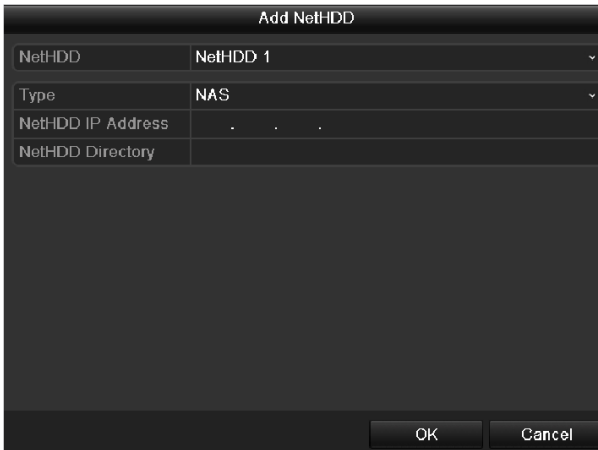

Add NetHDD

NetHDD	NetHDD 1
Type	NAS
NetHDD IP Address	
NetHDD Directory	

OK Cancel

Figure 12. 7 HDD Information Interface

3. Add the allocated NetHDD.
4. Select the type to NAS or IP SAN.
5. Configure the NAS or IP SAN settings.
 - **Add NAS disk:**
 - 1) Enter the NetHDD IP address in the text field.
 - 2) Click the **Search** button to search the available NAS disks.
 - 3) Select the NAS disk from the list shown below.

Or you can just manually enter the directory in the text field of NetHDD Directory.
 - 4) Click the **OK** button to add the configured NAS disk.



Up to 8 NAS disks can be added.

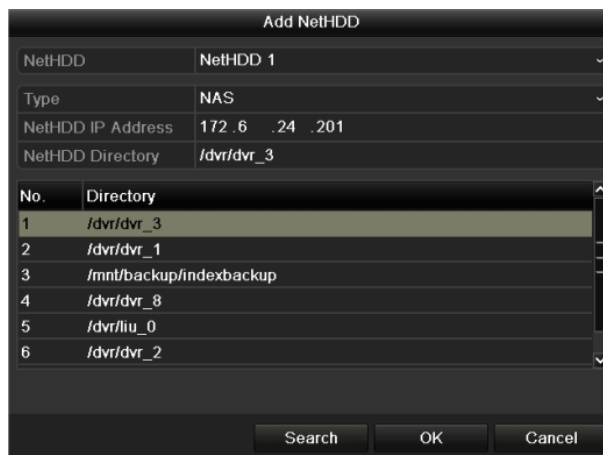

Figure 12. 8 Add NAS Disk

• **Add IP SAN:**

- 1) Enter the NetHDD IP address in the text field.
- 2) Click the **Search** button to search the available IP SAN disks.
- 3) Select the IP SAN disk from the list shown below.
- 4) Click the **OK** button to add the selected IP SAN disk.



Up to 1 IP SAN disk can be added.

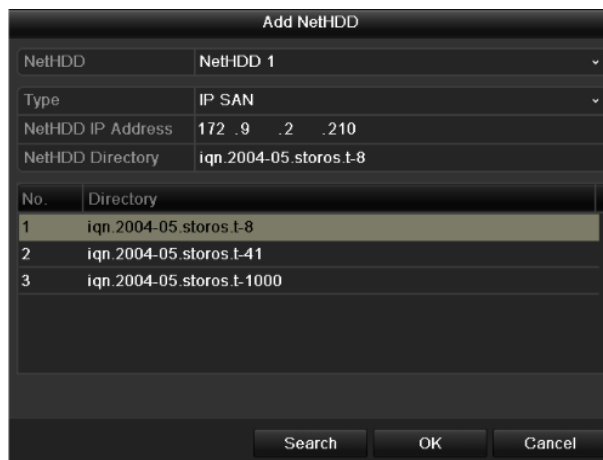

Figure 12. 9 Add IP SAN Disk

6. After having successfully added the NAS or IP SAN disk, return to the HDD Information menu. The added NetHDD will be displayed in the list.



If the added NetHDD is uninitialized, please select it and click the **Init** button for initialization.

Label	Capacity	Status	Property	Type	Free Space	Gro...	Edit	Del...
3	931.51GB	Normal	R/W	Local	890GB	1		-
4	931.51GB	Normal	R/W	Local	867GB	1		-
17	79,968MB	Normal	R/W	NAS	79,872MB	1		

Figure 12. 10 Initialize Added NetHDD

12.3 Managing eSATA

Purpose:

When there is an external eSATA device connected to NVR, you can configure eSATA for the use of Record/Capture or Export, and you can manage the eSATA in the NVR.

Steps:

1. Enter the Advanced Record Settings interface.

Menu >Record>Advanced

2. Select the eSATA type to Export or Record/Capture from the dropdown list of **eSATA**.

Export: use the eSATA for backup. Refer to *Backup using eSATA HDDs in Chapter Backing up by Normal Video Search* for operating instructions.

Record/Capture: use the eSATA for record/capture. Refer to the following steps for operating instructions.



Figure 12. 11 Set eSATA Mode

3. When the eSATA type is selected to Record/Capture, enter the HDD Information interface.

Menu > HDD>General

4. Edit the property of the selected eSATA, or initialize it is required.



Two storage modes can be configured for the eSATA when it is used for Record/Capture. Please refer to *Chapter Managing HDD Group* and *Chapter Configuring Quota Mode* for details.

Label	Capacity	Status	Property	Type	Free Space	Gro...	Edit	Del...
4	931.51GB	Normal	R/W	Local	921GB	1		
18	10,048MB	Uninitialized	R/W	NAS	0MB	1		
25	931.51GB	Normal	R/W	eSATA	894GB	1		

Figure 12. 12 Initialize Added eSATA

12.4 Managing HDD Group

12.4.1 Setting HDD Groups

Purpose:

Multiple HDDs can be managed in groups. Video from specified channels can be recorded onto a particular HDD group through HDD settings.

Steps:

1. Enter the Storage Mode interface.
Menu > HDD > Advanced > Storage Mode
2. Set the **Mode** to Group, as shown in Figure 12. 13.

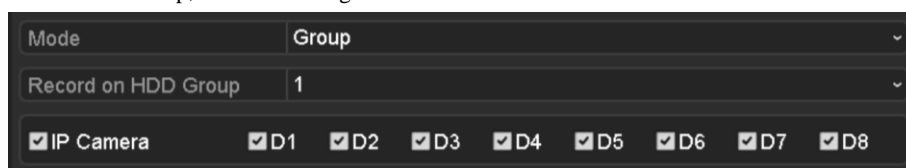

Figure 12. 13 Storage Mode Interface

3. Click the **Apply** button and the following Attention box will pop up.

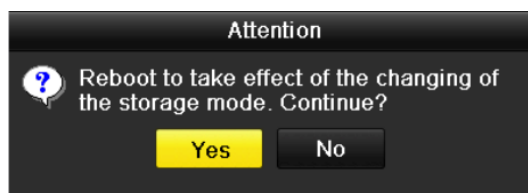



Figure 12. 14 Attention for Reboot

4. Click the **Yes** button to reboot the device to activate the changes.
5. After reboot of device, enter the HDD Information interface.
Menu > HDD> General
6. Select HDD from the list and click  icon to enter the Local HDD Settings interface, as shown in Figure 12. 15.

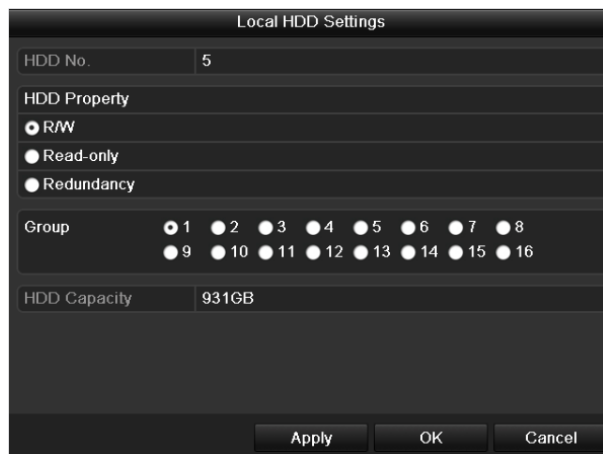

Figure 12. 15 Local HDD Settings Interface

7. Select the Group number for the current HDD.



The default group No. for each HDD is 1.

8. Click the **OK** button to confirm the settings.

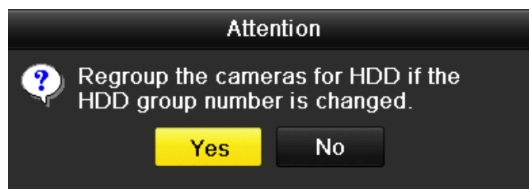

Figure 12. 16 Confirm HDD Group Settings

9. In the pop-up Attention box, click the **Yes** button to finish the settings.

12.4.2 Setting HDD Property

Purpose:

The HDD property can be set to redundancy, read-only or read/write (R/W). Before setting the HDD property, please set the storage mode to Group (refer to step1-4 of Chapter Setting HDD Groups).

A HDD can be set to read-only to prevent important recorded files from being overwritten when the HDD becomes full in overwrite recording mode.

When the HDD property is set to redundancy, the video can be recorded both onto the redundancy HDD and the R/W HDD simultaneously so as to ensure high security and reliability of video data.

Steps:

1. Enter the HDD Information interface.
Menu > HDD> General
2. Select HDD from the list and click the icon to enter the Local HDD Settings interface, as shown in Figure 12. 17.



Figure 12. 17 Set HDD Property

3. Set the HDD property to R/W, Read-only or Redundancy.
4. Click the **OK** button to save the settings and exit the interface.

5. In the HDD Information menu, the HDD property will be displayed in the list.



At least 2 hard disks must be installed on your NVR when you want to set a HDD to Redundancy, and there is one HDD with R/W property.

12.5 Configuring Quota Mode

Purpose:

Each camera can be configured with allocated quota for the storage of recorded files or captured pictures.

Steps:

1. Enter the Storage Mode interface.
Menu > HDD > Advanced
2. Set the **Mode** to Quota, as shown in Figure 12. 18.



The NVR must be rebooted to enable the changes to take effect.

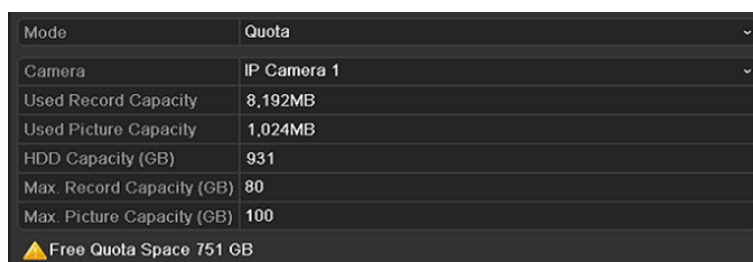

Figure 12. 18 Storage Mode Settings Interface

3. Select a camera for which you want to configure quota.
4. Enter the storage capacity in the text fields of **Max. Record Capacity (GB)** and **Max. Picture Capacity (GB)**, as shown in Figure 12. 19.

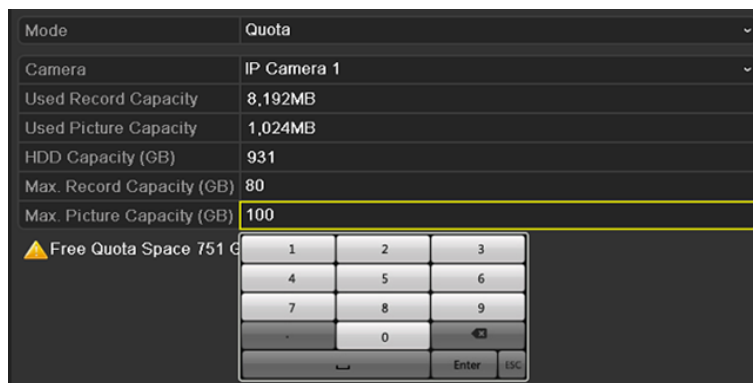

Figure 12. 19 Configure Record/Picture Quota

5. You can copy the quota settings of the current camera to other cameras if required. Click the **Copy** button to enter the Copy Camera menu, as shown in Figure 12. 20.



Figure 12. 20 Copy Settings to Other Camera(s)

6. Select the camera (s) to be configured with the same quota settings. You can also click the checkbox of IP Camera to select all cameras.
7. Click the **OK** button to finish the Copy settings and back to the Storage Mode interface.
8. Click the **Apply** button to apply the settings.



If the quota capacity is set to 0, then all cameras will use the total capacity of HDD for record and picture capture.

12.6 Configuring Disk Clone

Purpose:

If the S.M.A.R.T. detection result declares the HDD is abnormal, you can choose to clone all the data on the HDD to an inserted eSATA disk manually. Refer to *Chapter 12.8 HDD Detection* for details of S.M.A.R.T. detection.



This function is not supported by DS-7600NI series NVR.

Before you start:

An eSATA disk should be connected to the device.

Steps:

1. Enter the HDD Advanced Setting interface:
Menu > HDD > Advanced
2. Click the **Disk Clone** tab to enter the disk clone configuring interface.

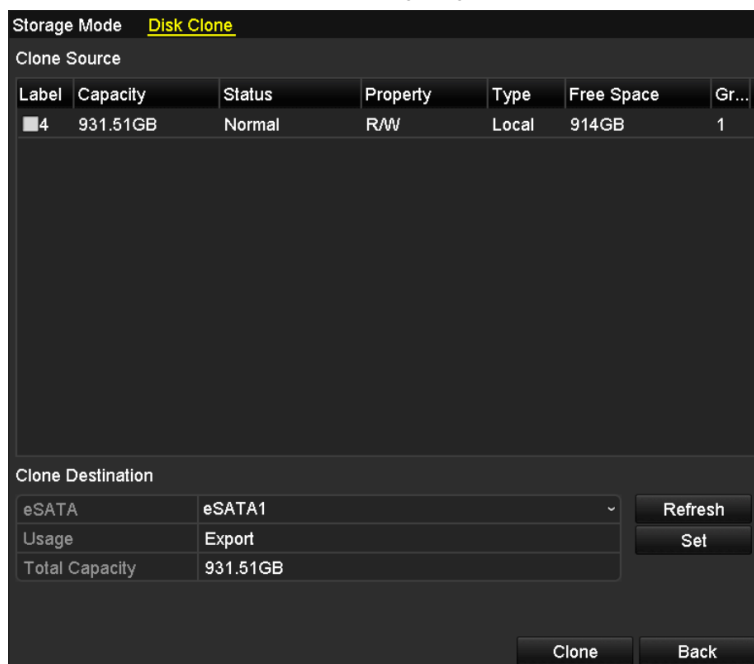

Figure 12. 21 Disk Clone Configuration Interface

3. Make sure the usage of the eSATA disk is set as Export.
If not, click the **Set** button to set it. Choose Export and click the **OK** button.

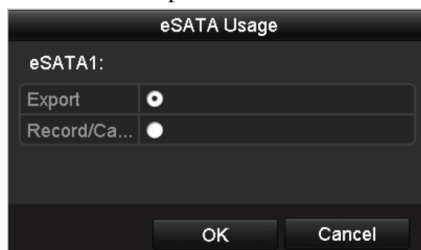

Figure 12. 22 Setting eSATA Usage



The capacity of destination disk must be the same as that of the clone source disk.

4. Check the checkbox of the HDD to be cloned in the Clone Source list.
5. Click the **Clone** button and a message box pops up.

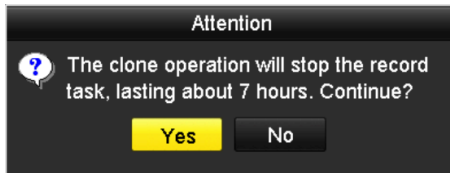

Figure 12. 23 Message Box for Disk Clone

6. Click the **Yes** button to continue.

You can check the clone progress in the HDD status.

Label	Capacity	Status	Property	Type	Free Space	Gr...
4	931.51GB	Cloning 01%	R/W	Local	0MB	1

Figure 12. 24 Check Disk Clone Progress

12.7 Checking HDD Status

Purpose:

You may check the status of the installed HDDs on NVR so as to take immediate check and maintenance in case of HDD failure.

Checking HDD Status in HDD Information Interface

Steps:

1. Enter the HDD Information interface.
Menu > HDD>General
2. Check the status of each HDD which is displayed on the list, as shown in Figure 12. 25.



Label	Capacity	Status	Property	Type	Free Space	Gro...	Edit	Del...
4	931.51GB	Normal	R/W	Local	921GB	1		
18	10,048MB	Uninitialized	R/W	NAS	0MB	1		
25	931.51GB	Normal	R/W	eSATA	894GB	1		

Total Capacity	1,872GB
Free Space	1,815GB

Figure 12. 25 View HDD Status (1)



If the status of HDD is *Normal* or *Sleeping*, it works normally. If the status is *Uninitialized* or *Abnormal*, please initialize the HDD before use. And if the HDD initialization is failed, please replace it with a new one.

Checking HDD Status in HDD Information Interface

Steps:

1. Enter the System Information interface.
Menu >Maintenance > System Info
2. Click the **HDD** tab to view the status of each HDD displayed on the list, as shown in Figure 12. 26.

The screenshot displays the 'HDD' status page. At the top, there are navigation tabs: 'Device Info', 'Camera', 'Record', 'Alarm', 'Network', and 'HDD'. Below the tabs is a table with the following data:

Label	Status	Capacity	Free Space	Property	Type	Group
5	Normal	931GB	931GB	R/W	Local	1
6	Sleeping	931GB	931GB	Redundancy	Local	1
17	Normal	40,000MB	22,528MB	R/W	IP SAN	1

Below the table, there is a summary section with two rows:

Total Capacity	1,902GB
Free Space	1,884GB

At the bottom right of the page, there is a yellow 'Back' button.

Figure 12. 26 View HDD Status (2)

12.8 HDD Detection



This function is not supported with DS-9600NI-RT series NVR.

Purpose:

The device provides the HDD detection function such as the adopting of the S.M.A.R.T. and the Bad Sector Detection technique. The S.M.A.R.T. (Self-Monitoring, Analysis and Reporting Technology) is a monitoring system for HDD to detect and report on various indicators of reliability in the hopes of anticipating failures.

S.M.A.R.T. Settings

Steps:

1. Enter the S.M.A.R.T Settings interface.
Menu > Maintenance >HDD Detect
2. Select the HDD to view its S.M.A.R.T information list, as shown in Figure 12. 27.

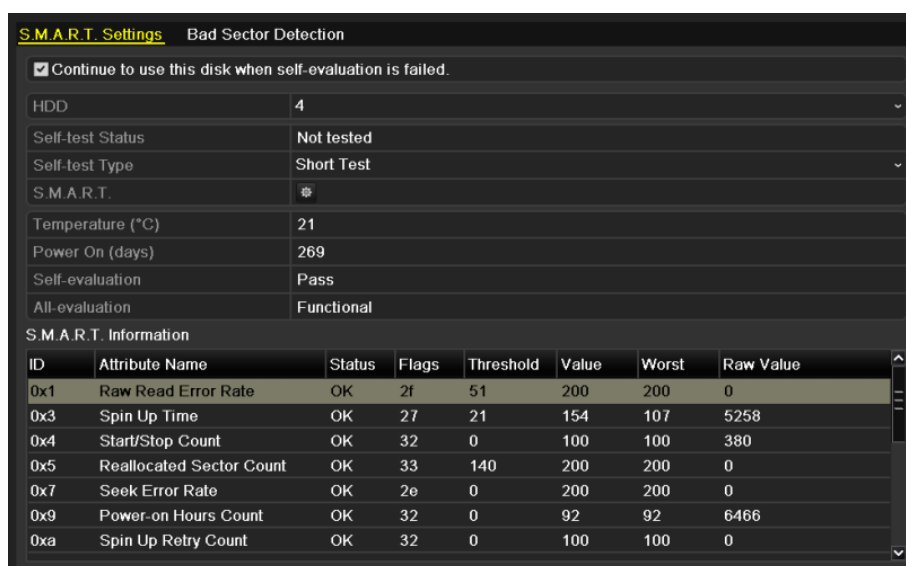

Figure 12. 27 S.M.A.R.T Settings Interface

The related information of the S.M.A.R.T. is shown on the interface.

You can choose the self-test types as Short Test, Expanded Test or the Conveyance Test.

Click the start button to start the S.M.A.R.T. HDD self-evaluation.



If you want to use the HDD even when the S.M.A.R.T. checking is failed, you can check the checkbox of the **Continue to use the disk when self-evaluation is failed** item.

Bad Sector Detection

Steps:

1. Click the Bad Sector Detection tab.
2. Select the HDD No. in the dropdown list you want to configure, and choose All Detection or Key Area Detection as the detection type.

3. Click the **Detect** button to start the detection.

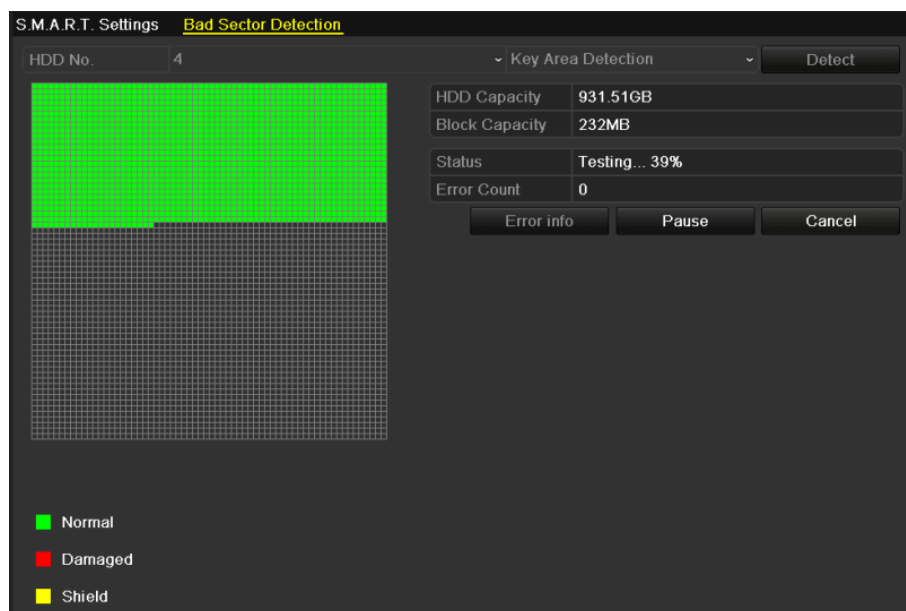

Figure 12. 28 Bad Sector Detection

And you can click **Error info** button to see the detailed damage information.

And you can also pause/resume or cancel the detection.

12.9 Configuring HDD Error Alarms

Purpose:

You can configure the HDD error alarms when the HDD status is *Uninitialized* or *Abnormal*.

Steps:

1. Enter the Exception interface.
Menu > Configuration > Exceptions
2. Select the Exception Type to **HDD Error** from the dropdown list.
3. Click the checkbox(s) below to select the HDD error alarm type (s), as shown in Figure 12. 29.



The alarm type can be selected to: Audible Warning, Notify Surveillance Center, Send Email and Trigger Alarm Output. Please refer to *Chapter Setting Alarm Response Actions*.

Exception Type	HDD Error
Audible Warning	<input type="checkbox"/>
Notify Surveillance Center	<input type="checkbox"/>
Send Email	<input type="checkbox"/>
Trigger Alarm Output	<input checked="" type="checkbox"/>
Alarm Output No.	Alarm Name
<input type="checkbox"/> Local->1	
<input type="checkbox"/> Local->2	
<input type="checkbox"/> Local->3	
<input type="checkbox"/> Local->4	
<input checked="" type="checkbox"/> 172.6.23.105:8000->1	

Figure 12. 29 Configure HDD Error Alarm

4. When the Trigger Alarm Output is selected, you can also select the alarm output to be triggered from the list below.
5. Click the **Apply** button to save the settings

Chapter 13 Camera Settings

13.1 Configuring OSD Settings

Purpose:

You can configure the OSD (On-screen Display) settings for the camera, including date /time, camera name, etc.

Steps:

1. Enter the OSD Configuration interface.
Menu > Camera > OSD
2. Select the camera to configure OSD settings.
3. Edit the Camera Name in the text field.
4. Configure the Display Name, Display Date and Display Week by clicking the checkbox.
5. Select the Date Format, Time Format and Display Mode.

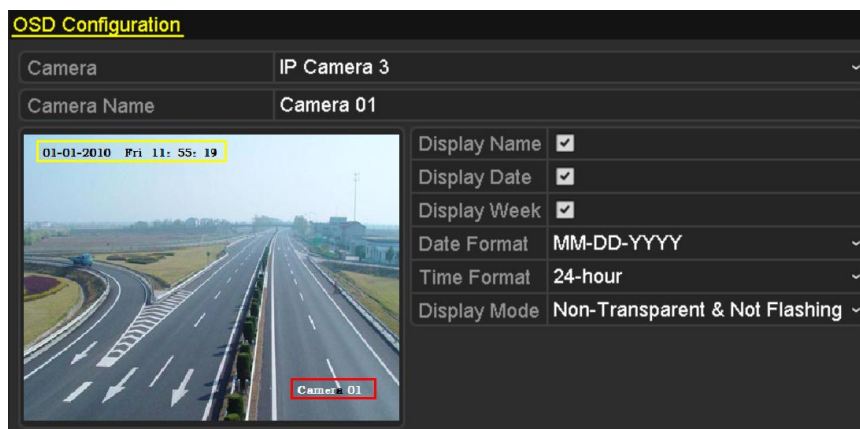

Figure 13. 1 OSD Configuration Interface

6. You can use the mouse to click and drag the text frame on the preview window to adjust the OSD position.
7. Click the **Apply** button to apply the settings.

13.2 Configuring Privacy Mask

Purpose:

You are allowed to configure the four-sided privacy mask zones that cannot be viewed by the operator. The privacy mask can prevent certain surveillance areas to be viewed or recorded.

Steps:

1. Enter the Privacy Mask Settings interface.
Menu > Camera > Privacy Mask
2. Select the camera to set privacy mask.
3. Click the checkbox of **Enable Privacy Mask** to enable this feature.

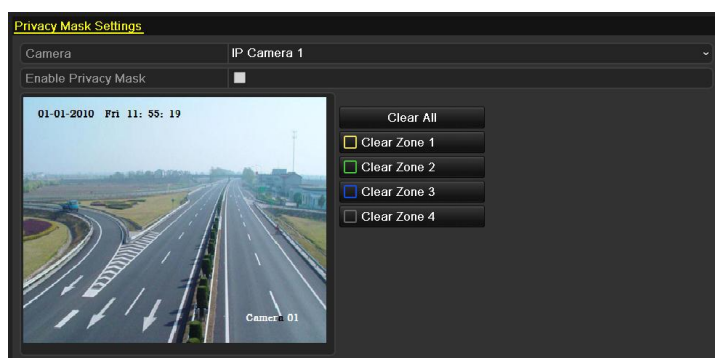

Figure 13.2 Privacy Mask Settings Interface

4. Use the mouse to draw a zone on the window. The zones will be marked with different frame colors.



Up to 4 privacy masks zones can be configured and the size of each area can be adjusted.

5. The configured privacy mask zones on the window can be cleared by clicking the corresponding Clear Zone1-4 icons on the right side of the window, or click **Clear All** to clear all zones.

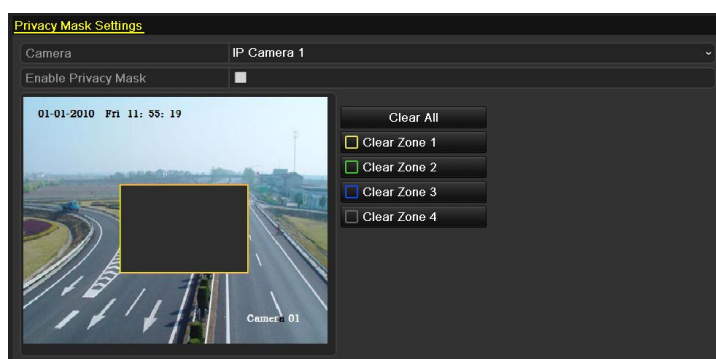

Figure 13.3 Set Privacy Mask Area

6. Click the **Apply** button to save the settings.

13.3 Configuring Video Parameters

Steps:

1. Enter the Image Settings interface.

Menu > Camera > Image

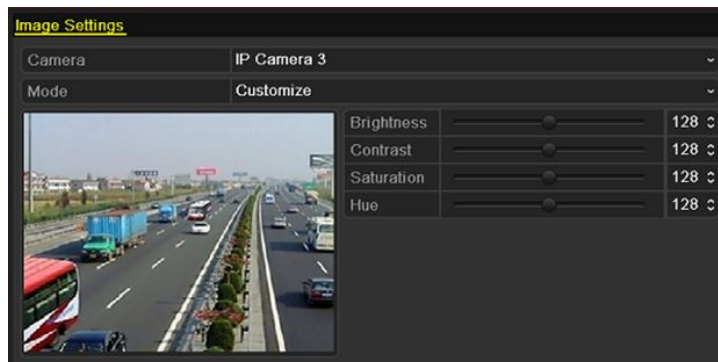

Figure 13.4 Image Settings Interface

2. Select the camera to set image parameters.
3. You can click on the arrow to change the value of each parameter.
4. Click the **Apply** button to save the settings.

Chapter 14 NVR Management and Maintenance

14.1 Viewing System Information

14.1.1 Viewing Device Information

Steps:

1. Enter the System Information interface.
Menu >Maintenance>System Info
2. Click the **Device Info** tab to enter the Device Information menu to view the device name, model, serial No. , firmware version and encode version, as shown in Figure 14. 1.

Device Info		Camera	Record	Alarm	Network	HDD
Device Name	Embedded Net DVR					
Model						
Serial No.	1620120518BBRR408508857WCVU					
Firmware Version						
Encoding Version	V1.0, Build 121210					

Figure 14. 1 Device Information Interface

14.1.2 Viewing Camera Information

Steps:

1. Enter the System Information interface.
Menu >Maintenance>System Info
2. Click the **Camera** tab to enter the Camera Information menu to view the status of each camera, as shown in Figure 14. 2.

Device Info		Camera	Record	Alarm	Network	HDD
Camera ...	Camera Name	Status	Motion Detection	Tamper-proof	Video Loss	
D1	Camera02	Connected	Occur	Used	Not used	
D2	Camera 01	Disconnected	Not supported	Not supported	Not supported	
D3	Camera03	Disconnected	Not supported	Not supported	Not supported	
D4	Camera04	Disconnected	Not supported	Not supported	Not supported	
D5	Camera05	Disconnected	Not supported	Not supported	Not supported	

Figure 14. 2 Camera Information Interface

14.1.3 Viewing Record Information

Steps:

1. Enter the System Information interface.
Menu >Maintenance>System Info
2. Click the **Record** tab to enter the Record Information menu to view the recording status and parameters of each camera, as shown in Figure 14. 3.

Camera No	Recording	Stream Typ	Frame Rate	Bitrate(Kbps)	Resolution	Record Typ	Encoding P	Redundant
D1	Used	Video & Au	30fps	2048	704*576(4CIF)	Manual	Event	No
D2	Used	Video	30fps	2048	1600*1200(UXG)	Manual	Normal	No
D3	Not used	Video & Au	30fps	2048	704*576(4CIF)		Normal	No
D5	Not used	Video	30fps	2048	4CIF		Normal	No
D6	Not used	Video & Au	30fps	2048	4CIF		Normal	No
D7	Not used	Video	30fps	2048	4CIF		Normal	No

Figure 14. 3 Record Information Interface

14.1.4 Viewing Alarm Information

Steps:

1. Enter the System Information interface.
Menu >Maintenance>System Info
2. Click the **Alarm** tab to enter the Alarm Information menu to view the alarm information, as shown in Figure 14. 4.

No.	Alarm Name	Alarm Type	Alarm Status	Triggered Camer
Local<-1		N.C	Occur	D3~D4 D7
Local<-2		N.O	Used	
Local<-3		N.O	Used	
Local<-4		N.O	Used	
Local<-5		N.O	Used	
Local<-6		N.C	Occur	D3~D4 D7
Local<-7		N.O	Used	
Local<-8		N.O	Used	
Local<-9		N.O	Used	
Local<-10		N.C	Occur	
Local<-11		N.C	Occur	
Local<-12		N.O	Used	
Local<-13		N.O	Used	
Local<-14		N.O	Used	
Local<-15		N.O	Used	

Figure 14. 4 Alarm Information Interface

14.1.5 Viewing Network Information

Steps:

1. Enter the System Information interface.
Menu >Maintenance>System Info
2. Click the **Network** tab to enter the Network Information menu to view the network information, as shown in Figure 14. 5.

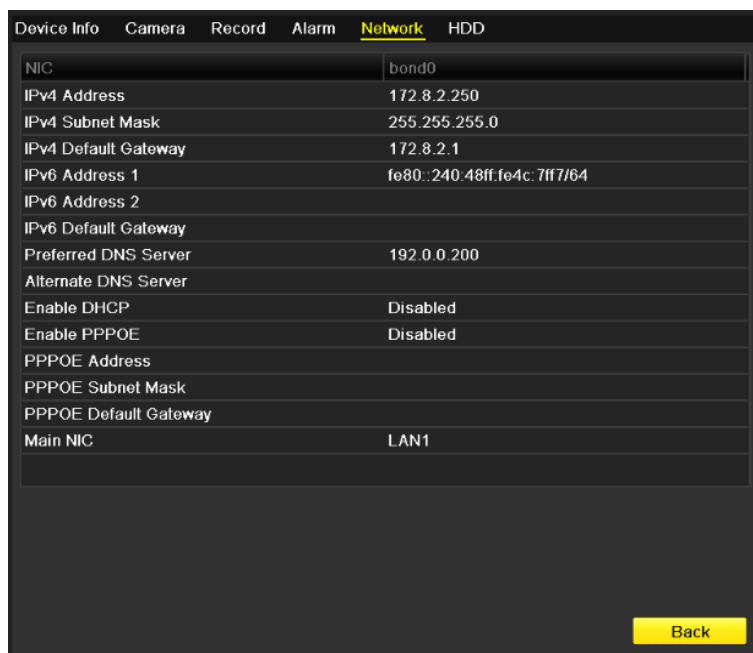

Figure 14. 5 Network Information Interface

14.1.6 Viewing HDD Information

Steps:

1. Enter the System Information interface.
Menu > Maintenance > System Info
2. Click the **HDD** tab to enter the HDD Information menu to view the HDD status, free space, property, etc., as shown in Figure 14. 6.

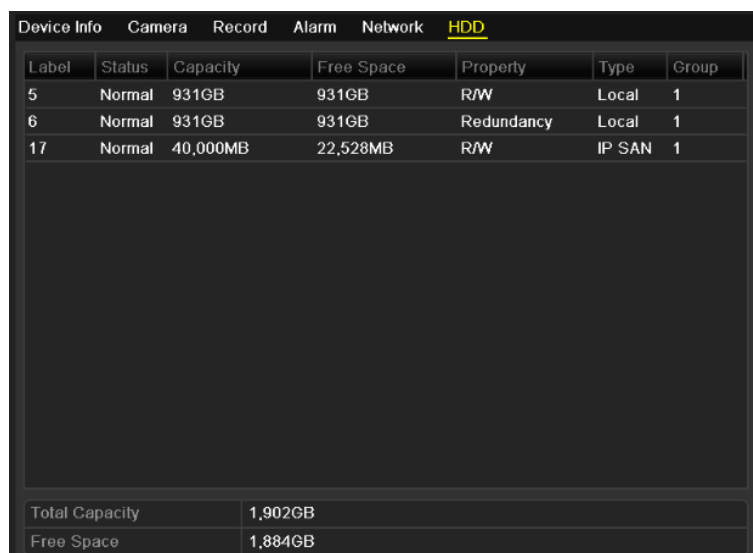

Figure 14. 6 HDD Information Interface

14.2 Searching & Export Log Files

Purpose:

The operation, alarm, exception and information of the NVR can be stored in log files, which can be viewed and exported at any time.

Steps:

1. Enter the Log Search interface.
Menu > Maintenance > Log Information



Figure 14. 7 Log Search Interface

2. Set the log search conditions to refine your search, including the Start Time, End Time, Major Type and Minor Type.
3. Click the **Search** button to start search log files.
4. The matched log files will be displayed on the list shown below.

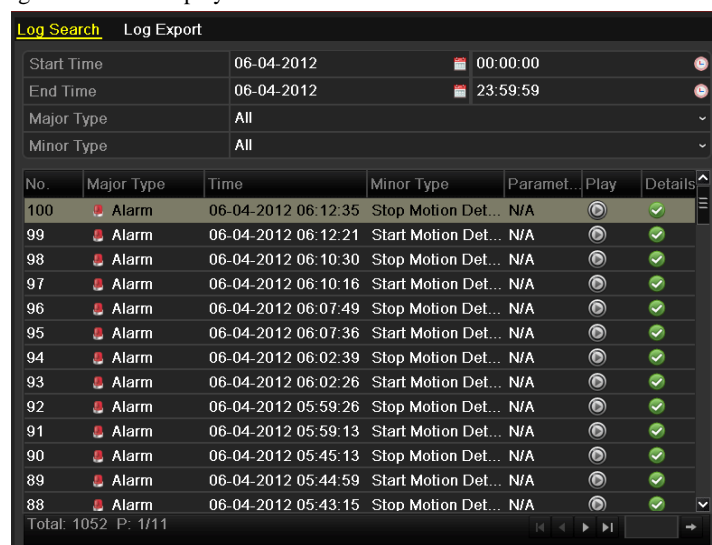

Figure 14. 8 Log Search Results



Up to 2000 log files can be displayed each time.

5. You can click the button of each log or double click it to view its detailed information, as shown in Figure 14. 9. And you can also click the button to view the related video files if available.

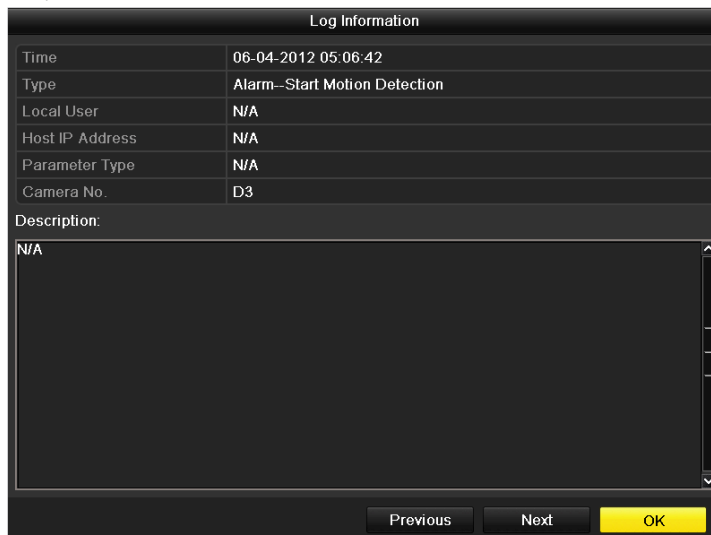

Figure 14. 9 Log Details

6. If you want to export the log files, click the **Export** button to enter the Export menu, as shown in Figure 14. 10.



Figure 14. 10 Export Log Files

7. Select the backup device from the dropdown list of **Device Name**.
8. Click the **Export** to export the log files to the selected backup device.
You can click the **New Folder** button to create new folder in the backup device, or click the **Format** button to format the backup device before log export.



- Please connect the backup device to NVR before operating log export.
- The log files exported to the backup device are named by exporting time, e.g.,
20110514124841logBack.txt.

To export all the log files:

Steps:

1. Enter the Log Information interface.
Menu> Maintenance> Log Information> Log Export
2. Click the **Log Export** tab.

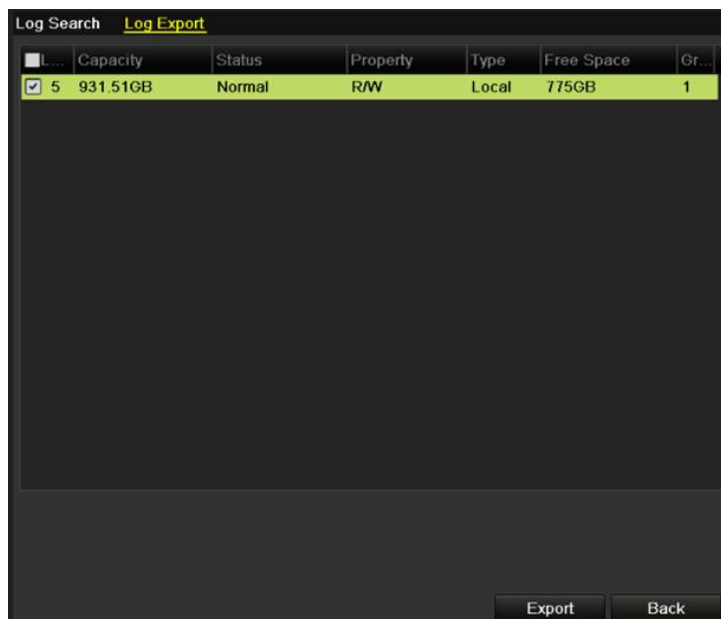

Figure 14. 11 Log Export Interface

3. You can check the checkbox of the HDD.
4. Click the **Export** button to export all the log files stored in the HDD.

14.3 Importing/Exporting IP Camera Info

Purpose:

The information of added IP camera can be generated into an excel file and exported to the local device for backup, including the IP address, manage port, password of admin, etc.. And the exported file can be edited on your PC, like adding or deleting the content, and copy the setting to other devices by importing the excel file to it.

Steps:

1. Enter the camera management interface.
Menu > Camera > IP Camera Import/Export
2. Click the IP Camera Import/Export tab, the content of detected plugged external device appears.
3. Click the **Export** button to export configuration files to the selected local backup device.
4. To import a configuration file, select the file from the selected backup device and click the **Import** button.
After the importing process is completed, you must reboot the NVR.

14.4 Importing/Exporting Configuration Files

Purpose:

The configuration files of the NVR can be exported to local device for backup; and the configuration files of one NVR can be imported to multiple NVR devices if they are to be configured with the same parameters.

Steps:

1. Enter the Import/Export Configuration File interface.

Menu > Maintenance > Import/Export



Figure 14. 12 Import/Export Config File

2. Click the **Export** button to export configuration files to the selected local backup device.
3. To import a configuration file, select the file from the selected backup device and click the **Import** button. After the import process is completed, you must reboot the NVR.



After having finished the import of configuration files, the device will reboot automatically.

14.5 Upgrading System

Purpose:

The firmware on your NVR can be upgraded by local backup device or remote FTP server.

14.5.1 Upgrading by Local Backup Device

Steps:

1. Connect your NVR with a local backup device where the update firmware file is located.
2. Enter the Upgrade interface.
Menu >Maintenance>Upgrade
3. Click the **Local Upgrade** tab to enter the local upgrade menu, as shown in Figure 14. 13.

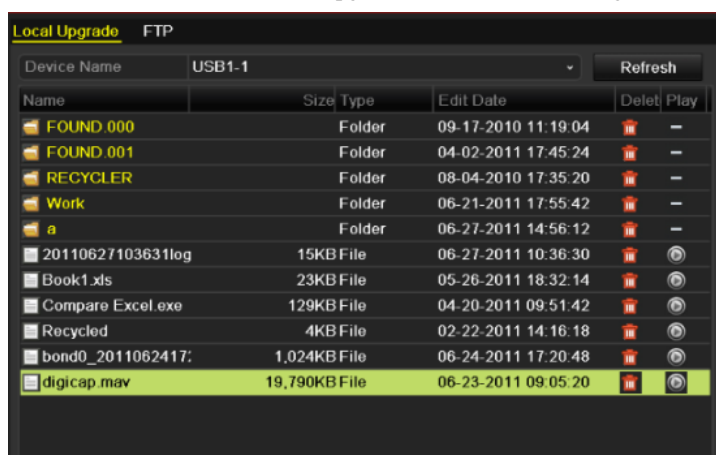

Figure 14. 13 Local Upgrade Interface

4. Select the update file from the backup device.
5. Click the **Upgrade** button to start upgrading.
6. After the upgrading is complete, reboot the NVR to activate the new firmware.

14.5.2 Upgrading by FTP

Before you start:

Configure PC (running FTP server) and NVR to the same Local Area Network. Run the 3rd-party TFTP software on the PC and copy the firmware into the root directory of TFTP.

Steps:

1. Enter the Upgrade interface.
Menu >Maintenance>Upgrade
2. Click the **FTP** tab to enter the local upgrade interface, as shown in Figure 14. 14.

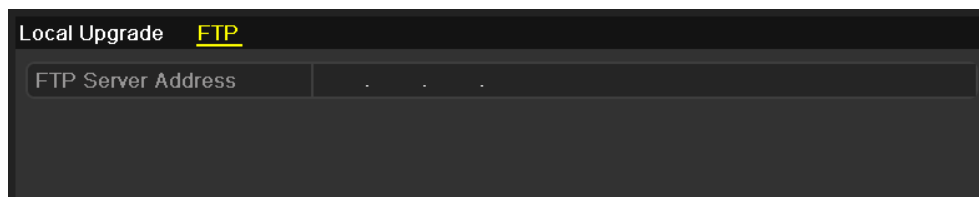

Figure 14. 14 FTP Upgrade Interface

3. Enter the FTP Server Address in the text field.
4. Click the **Upgrade** button to start upgrading.
5. After the upgrading is complete, reboot the NVR to activate the new firmware.

14.6 Restoring Default Settings

Steps:

1. Enter the Default interface.

Menu > Maintenance > Default

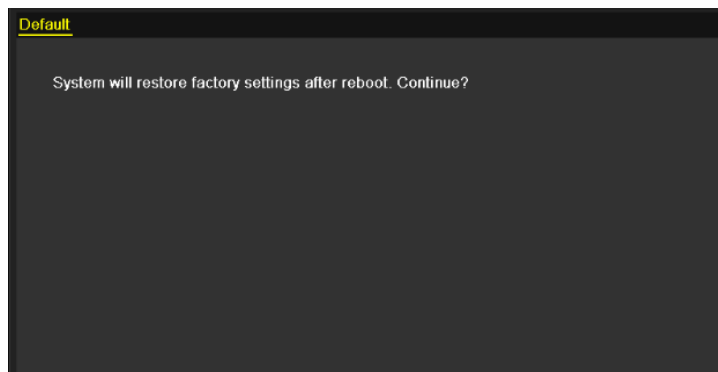

Figure 14. 15 Restore Factory Default

2. Click the **OK** button to restore the default settings.



Except the network parameters (including IP address, subnet mask, gateway, MTU, NIC working mode, default route and server port), all other parameters of the device will be restored to factory default settings.

Chapter 15 Others

15.1 Configuring RS-232 Serial Port

Purpose:

The RS-232 port can be used in two ways:

- **Parameters Configuration:** Connect a PC to the NVR through the PC serial port. Device parameters can be configured by using software such as HyperTerminal. The serial port parameters must be the same as the NVR's when connecting with the PC serial port.
- **Transparent Channel:** Connect a serial device directly to the NVR. The serial device will be controlled remotely by the PC through the network and the protocol of the serial device.

Steps:

1. Enter the RS-232 Settings interface.

Menu >Configuration> RS-232



Figure 15. 1 RS-232 Settings Interface

2. Configure RS-232 parameters, including baud rate, data bit, stop bit, parity, flow control and usage.
3. Click the **Apply** button to save the settings.

15.2 Configuring General Settings

Purpose:

You can configure the BNC output standard, VGA output resolution, mouse pointer speed through the Menu > Configuration > General interface.

Steps:

1. Enter the General Settings interface.
Menu > Configuration > General
2. Select the **General** tab.

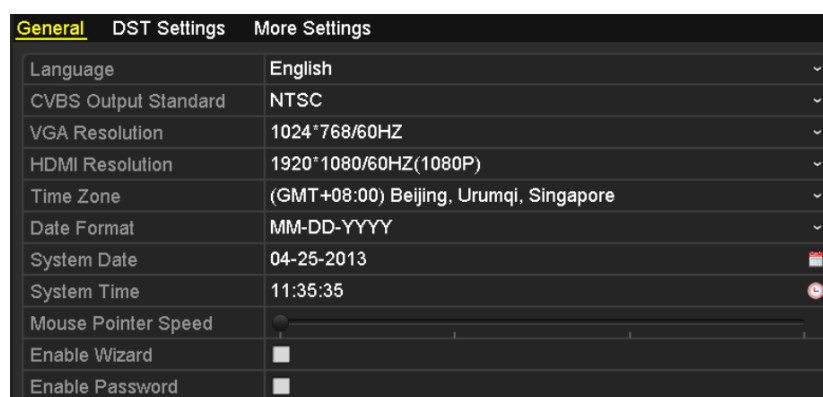

Figure 15. 2 General Settings Interface

3. Configure the following settings:
 - **Language:** The default language used is *English*.
 - **CVBS Output Standard:** Select the CVBS output standard to NTSC or PAL, which must be the same with the video input standard.
 - **VGA Resolution:** Select the VGA output resolution, which must be the same with the resolution of the monitor screen.
 - **HDMI Resolution:** Select the HDMI resolution, which must be the same with the resolution of the monitor screen.
 - **Time Zone:** Select the time zone.
 - **Date Format:** Select the date format.
 - **System Date:** Select the system date.
 - **System Time:** Select the system time.
 - **Mouse Pointer Speed:** Set the speed of mouse pointer; 4 levels are configurable.
 - **Enable Wizard:** Enable/disable the Wizard when the device starts up.
 - **Enable Password:** Enable/disable the use of the login password.
4. Click the **Apply** button to save the settings.

15.3 Configuring DST Settings

Steps:

1. Enter the General Settings interface.

Menu >Configuration>General

2. Choose **DST Settings** tab.



The screenshot shows the 'DST Settings' tab in a configuration interface. It includes a checkbox for 'Auto DST Adjustment', an 'Enable DST' checkbox, and fields for 'From' and 'To' dates and times, along with a 'DST Bias' dropdown menu.

Setting	Value
Auto DST Adjustment	<input type="checkbox"/>
Enable DST	<input checked="" type="checkbox"/>
From	Apr 1st Sun 2 : 00
To	Oct last Sun 2 : 00
DST Bias	60 Minutes

Figure 15. 3 DST Settings Interface

You can check the checkbox before the Auto DST Adjustment item.

Or you can manually check the Enable DST checkbox, and then you choose the date of the DST period.

15.4 Configuring More Settings for Device Parameters

Steps:

1. Enter the General Settings interface.
Menu >Configuration>General
2. Click the **More Settings** tab to enter the More Settings interface, as shown in Figure 15. 4.

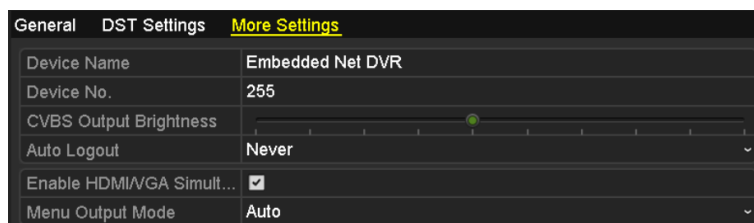

Figure 15. 4 More Settings Interface

3. Configure the following settings:
 - **Device Name:** Edit the name of NVR.
 - **Device No.:** Edit the serial number of NVR. The Device No. can be set in the range of 1~255, and the default No. is 255. The number is used for the remote and keyboard control.
 - **CVBS Output Brightness:** Adjust the video output brightness.
 - **Auto Logout:** Set timeout time for menu inactivity. E.g., when the timeout time is set to *5 Minutes*, then the system will exit from the current operation menu to live view screen after 5 minutes of menu inactivity.
 - **Enable HDMI/VGA Simultaneous Output:** By default, the video outputs from HDMI and VGA interfaces can be operated separately. You can set the simultaneous output for the HDMI and VGA by checking the checkbox of the option.
 - **Menu Output Mode:** You can choose the menu display on different video output. There are auto, HDMI, VGA and Main CVBS selectable.
4. Click the **Apply** button to save the settings.

15.5 Managing User Accounts

Purpose:

There is a default account in the NVR: *Administrator*. The *Administrator* user name is *admin* and the password is *12345*. The *Administrator* has the permission to add and delete user and configure user parameters.

15.5.1 Adding a User

Steps:

1. Enter the User Management interface.

Menu >Configuration>User

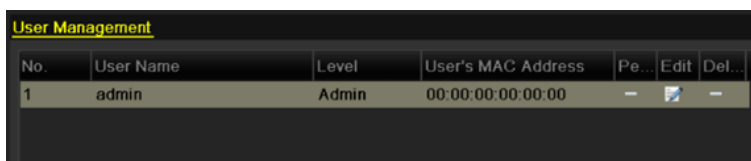

Figure 15. 5 User Management Interface

2. Click the **Add** button to enter the Add User interface.

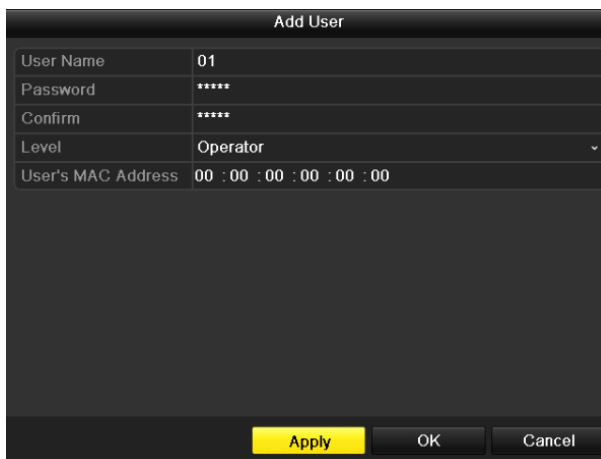

Figure 15. 6 Add User Menu

3. Enter the information for new user, including **User Name**, **Password**, **Level** and **User's MAC Address**.

Level: Set the user level to Operator or Guest. Different user levels have different operating permission.

- **Operator:** The *Operator* user level has permission of Two-way Audio in Remote Configuration and all operating permission in Camera Configuration by default.
- **Guest:** The *Guest* user has no permission of Two-way Audio in Remote Configuration and only has the local/remote playback in the Camera Configuration by default.

User's MAC Address: The MAC address of the remote PC which logs onto the NVR. If it is configured and enabled, it only allows the remote user with this MAC address to access the NVR.

4. Click the **OK** button to save the settings and go back to the User Management interface. The added new user will be displayed on the list, as shown in Figure 15. 7.

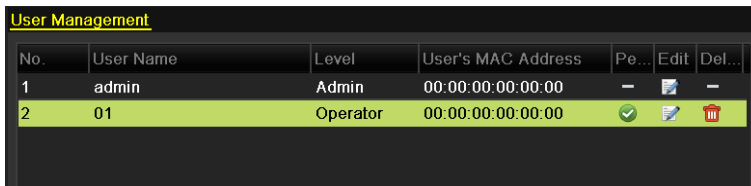

Figure 15. 7 Added User Listed in User Management Interface

5. Select the user from the list and then click the button to enter the Permission settings interface, as shown in Figure 15. 8.



Figure 15. 8 User Permission Settings Interface

6. Set the operating permission of Local Configuration, Remote Configuration and Camera Configuration for the user.

Local Configuration

- Local Log Search: Searching and viewing logs and system information of NVR.
- Local Parameters Settings: Configuring parameters, restoring factory default parameters and importing/exporting configuration files.
- Local Camera Management: The adding, deleting and editing of IP cameras.
- Local Advanced Operation: Operating HDD management (initializing HDD, setting HDD property), upgrading system firmware, clearing I/O alarm output.
- Local Shutdown Reboot: Shutting down or rebooting the NVR.

Remote Configuration

- Remote Log Search: Remotely viewing logs that are saved on the NVR.
- Remote Parameters Settings: Remotely configuring parameters, restoring factory default parameters and importing/exporting configuration files.
- Remote Camera Management: Remote adding, deleting and editing of the IP cameras.
- Remote Serial Port Control: Configuring settings for RS-232 and RS-485 ports.
- Remote Video Output Control: Sending remote button control signal.
- Two-Way Audio: Realizing two-way radio between the remote client and the NVR.
- Remote Alarm Control: Remotely arming (notify alarm and exception message to the remote client) and controlling the alarm output.
- Remote Advanced Operation: Remotely operating HDD management (initializing HDD, setting HDD property), upgrading system firmware, clearing I/O alarm output.
- Remote Shutdown/Reboot: Remotely shutting down or rebooting the NVR.

Camera Configuration

- Remote Live View: Remotely viewing live video of the selected camera (s).

- Local Manual Operation: Locally starting/stopping manual recording, picture capturing and alarm output of the selected camera (s).
 - Remote Manual Operation: Remotely starting/stopping manual recording, picture capturing and alarm output of the selected camera (s).
 - Local Playback: Locally playing back recorded files of the selected camera (s).
 - Remote Playback: Remotely playing back recorded files of the selected camera (s).
 - Local PTZ Control: Locally controlling PTZ movement of the selected camera (s).
 - Remote PTZ Control: Remotely controlling PTZ movement of the selected camera (s).
 - Local Video Export: Locally exporting recorded files of the selected camera (s).
7. Click the **OK** button to save the settings and exit interface.



Only the *admin* user account has the permission of restoring factory default parameters.

15.5.2 Deleting a User

Steps:

1. Enter the User Management interface.
Menu >Configuration>User
2. Select the user to be deleted from the list, as shown in Figure 15. 9.

No.	User Name	Level	User's MAC Address	Pe...	Edit	Del...
1	admin	Admin	00:00:00:00:00:00	-		-
2	01	Operator	00:00:00:00:00:00			

Figure 15. 9 User List

3. Click the icon to delete the selected user.

15.5.3 Editing a User

Steps:

1. Enter the User Management interface.
Menu >Configuration>User
2. Select the user to be edited from the list, as shown in Figure 15. 9.
3. Click the icon to enter the Edit User interface, as shown in Figure 15. 10.



The admin user can also be edited.



Edit User	
User Name	01
Password	*****
Confirm	*****
Level	Operator
User's MAC Address	00 : 00 : 00 : 00 : 00 : 00

Operator and Guest



Edit User	
User Name	admin
Old Password	
Change Password	<input type="checkbox"/>
Password	
Confirm	
User's MAC Address	00 : 00 : 00 : 00 : 00 : 00

Admin

Figure 15. 10 Edit User Interface

4. Edit the corresponding parameters.
 - **Operator and Guest**

You can edit the user information, including user name, password, permission level and MAC address. Check the checkbox of **Change Password** if you want to change the password, and input the new one in the text field of **Password** and **Confirm**.
 - **Admin**

You are only allowed to edit password and MAC address. Check the checkbox of **Change Password** if you want to change the password, and the input the correct old password, and the new one in the text field of **Password** and **Confirm**.
5. Click the **OK** button to save the settings and exit the menu.

Appendix

Glossary

- **Dual Stream:** Dual stream is a technology used to record high resolution video locally while transmitting a lower resolution stream over the network. The two streams are generated by the DVR, with the main stream having a maximum resolution of 4CIF and the sub-stream having a maximum resolution of CIF.
- **HDD:** Acronym for Hard Disk Drive. A storage medium which stores digitally encoded data on platters with magnetic surfaces.
- **DHCP:** Dynamic Host Configuration Protocol (DHCP) is a network application protocol used by devices (DHCP clients) to obtain configuration information for operation in an Internet Protocol network.
- **HTTP:** Acronym for Hypertext Transfer Protocol. A protocol to transfer hypertext request and information between servers and browsers over a network
- **PPPoE:** PPPoE, Point-to-Point Protocol over Ethernet, is a network protocol for encapsulating Point-to-Point Protocol (PPP) frames inside Ethernet frames. It is used mainly with ADSL services where individual users connect to the ADSL transceiver (modem) over Ethernet and in plain Metro Ethernet networks.
- **DDNS:** Dynamic DNS is a method, protocol, or network service that provides the capability for a networked device, such as a router or computer system using the Internet Protocol Suite, to notify a domain name server to change, in real time (ad-hoc) the active DNS configuration of its configured hostnames, addresses or other information stored in DNS.
- **Hybrid DVR:** A hybrid DVR is a combination of a DVR and NVR.
- **NTP:** Acronym for Network Time Protocol. A protocol designed to synchronize the clocks of computers over a network.
- **NTSC:** Acronym for National Television System Committee. NTSC is an analog television standard used in such countries as the United States and Japan. Each frame of an NTSC signal contains 525 scan lines at 60Hz.
- **NVR:** Acronym for Network Video Recorder. An NVR can be a PC-based or embedded system used for centralized management and storage for IP cameras, IP Domes and other DVRs.
- **PAL:** Acronym for Phase Alternating Line. PAL is also another video standard used in broadcast televisions systems in large parts of the world. PAL signal contains 625 scan lines at 50Hz.
- **PTZ:** Acronym for Pan, Tilt, Zoom. PTZ cameras are motor driven systems that allow the camera to pan left and right, tilt up and down and zoom in and out.
- **USB:** Acronym for Universal Serial Bus. USB is a plug-and-play serial bus standard to interface devices to a host computer.

Troubleshooting

- **No image displayed on the monitor after starting up normally.**

Possible Reasons

- a) No VGA or HDMI connections.
- b) Connection cable is damaged.
- c) Input mode of the monitor is incorrect.

Steps

1. Verify the device is connected with the monitor via HDMI or VGA cable.
If not, please connect the device with the monitor and reboot.
2. Verify the connection cable is good.
If there is still no image display on the monitor after rebooting, please check if the connection cable is good, and change a cable to connect again.
3. Verify Input mode of the monitor is correct.
Please check the input mode of the monitor matches with the output mode of the device (e.g. if the output mode of NVR is HDMI output, then the input mode of monitor must be the HDMI input). And if not, please modify the input mode of monitor.
4. Check if the fault is solved by the step 1 to step 3.
If it is solved, finish the process.
If not, please contact the engineer from our company to do the further process.

- **There is an audible warning sound “Di-Di-Di-DiDi” after a new bought NVR starts up.**

Possible Reasons

- a) No HDD is installed in the device.
- b) The installed HDD has not been initialized.
- c) The installed HDD is not compatible with the NVR or is broken-down.

Steps

1. Verify at least one HDD is installed in the NVR.
 - 1) If not, please install the compatible HDD.
 Please refer to the “Quick Operation Guide” for the HDD installation steps.
 - 2) If you don’t want to install a HDD, select “Menu>Configuration > Exceptions”, and uncheck the Audible Warning checkbox of “HDD Error”.
2. Verify the HDD is initialized.
 - 1) Select “Menu>HDD>General”.
 - 2) If the status of the HDD is “Uninitialized”, please check the checkbox of corresponding HDD and click the “Init” button.
3. Verify the HDD is detected or is in good condition.
 - 1) Select “Menu>HDD>General”.
 - 2) If the HDD is not detected or the status is “Abnormal”, please replace the dedicated HDD according to the requirement.
4. Check if the fault is solved by the step 1 to step 3.
If it is solved, finish the process.
If not, please contact the engineer from our company to do the further process.

- **The status of the added IP camera displays as “Disconnected” when it is connected through Private**

Protocol. Select “Menu>Camera>Camera>IP Camera” to get the camera status.

Possible Reasons

- a) Network failure, and the NVR and IP camera lost connections.
- b) The configured parameters are incorrect when adding the IP camera.
- c) Insufficient bandwidth.

Steps

1. Verify the network is connected.
 - 1) Connect the NVR and PC with the RS-232 cable.
 - 2) Open the Super Terminal software, and execute the ping command. Input “ping IP” (e.g. ping 172.6.22.131).



Simultaneously press **Ctrl** and **C** to exit the ping command.

If there exists return information and the time value is little, the network is normal.

2. Verify the configuration parameters are correct.
 - 1) Select “Menu>Camera>Camera>IP Camera”.
 - 2) Verify the following parameters are the same with those of the connected IP devices, including IP address, protocol, management port, user name and password.
3. Verify the whether the bandwidth is enough.
 - 1) Select “Menu >Maintenance > Net Detect > Network Stat.”.
 - 2) Check the usage of the access bandwidth, and see if the total bandwidth has reached its limit.
4. Check if the fault is solved by the step 1 to step 3.

If it is solved, finish the process.

If not, please contact the engineer from our company to do the further process.

- **The IP camera frequently goes online and offline and the status of it displays as “Disconnected”.**

Possible Reasons

- a) The IP camera and the NVR versions are not compatible.
- b) Unstable power supply of IP camera.
- c) Unstable network between IP camera and NVR.
- d) Limited flow by the switch connected with IP camera and NVR.

Steps

1. Verify the IP camera and the NVR versions are compatible.
 - 1) Enter the IP camera Management interface “Menu > Camera > Camera>IP Camera”, and view the firmware version of connected IP camera.
 - 2) Enter the System Info interface “Menu>Maintenance>System Info>Device Info”, and view the firmware version of NVR.
2. Verify power supply of IP camera is stable.
 - 1) Verify the power indicator is normal.
 - 2) When the IP camera is offline, please try the ping command on PC to check if the PC connects with the IP camera.
3. Verify the network between IP camera and NVR is stable.
 - 1) When the IP camera is offline, connect PC and NVR with the RS-232 cable.
 - 2) Open the Super Terminal, use the ping command and keep sending large data packages to the connected IP camera, and check if there exists packet loss.



Simultaneously press **Ctrl** and **C** to exit the ping command.

Example: Input **ping 172.6.22.131 -l 1472 -f**.

4. Verify the switch is not flow control.

Check the brand, model of the switch connecting IP camera and NVR, and contact with the manufacturer of the switch to check if it has the function of flow control. If so, please turn it down.

5. Check if the fault is solved by the step 1 to step 4.

If it is solved, finish the process.

If not, please contact the engineer from our company to do the further process.

- **No monitor connected with the NVR locally and when you manage the IP camera to connect with the device by web browser remotely, of which the status displays as Connected. And then you connect the device with the monitor via VGA or HDMI interface and reboot the device, there is black screen with the mouse cursor.**

Connect the NVR with the monitor before startup via VGA or HDMI interface, and manage the IP camera to connect with the device locally or remotely, the status of IP camera displays as Connect. And then connect the device with the CVBS, and there is black screen either.

Possible Reasons:

After connecting the IP camera to the NVR, the image is output via the main spot interface by default.

Steps:

1. Enable the output channel.
2. Select “Menu > Configuration > Live View > View”, and select video output interface in the drop-down list and configure the window you want to view.



- The view settings can only be configured by the local operation of NVR.
 - Different camera orders and window-division modes can be set for different output interfaces separately, and digits like “D1” and “D2” stands for the channel number, and “X” means the selected window has no image output.
3. Check if the fault is solved by the above steps.

If it is solved, finish the process.

If not, please contact the engineer from our company to do the further process.

- **Live view stuck when video output locally.**

Possible Reasons:

- a) Poor network between NVR and IP camera, and there exists packet loss during the transmission.
- b) The frame rate has not reached the real-time frame rate.

Steps:

1. Verify the network between NVR and IP camera is connected.
 - 1) When image is stuck, connect the RS-232 ports on PC and the rear panel of NVR with the RS-232 cable.
 - 2) Open the Super Terminal, and execute the command of “**ping 192.168.0.0 -l 1472 -f**” (the IP address may change according to the real condition), and check if there exists packet loss.



Simultaneously press **Ctrl** and **C** to exit the ping command.

2. Verify the frame rate is real-time frame rate.

Select “Menu > Record > Parameters > Record”, and set the Frame rate to Full Frame.

3. Check if the fault is solved by the above steps.

If it is solved, finish the process.

If not, please contact the engineer from our company to do the further process.

- **Live view stuck when video output remotely via the Internet Explorer or platform software.**

Possible Reasons:

- a) Poor network between NVR and IP camera, and there exists packet loss during the transmission.
- b) Poor network between NVR and PC, and there exists packet loss during the transmission.
- c) The performances of hardware are not good enough, including CPU, memory, etc..

Steps:

1. Verify the network between NVR and IP camera is connected.
 - 1) When image is stuck, connect the RS-232 ports on PC and the rear panel of NVR with the RS-232 cable.
 - 2) Open the Super Terminal, and execute the command of “**ping 192.168.0.0 -l 1472 -f**” (the IP address may change according to the real condition), and check if there exists packet loss.



Simultaneously press **Ctrl** and **C** to exit the ping command.

2. Verify the network between NVR and PC is connected.
 - 1) Open the cmd window in the Start menu, or you can press “windows+R” shortcut key to open it.
 - 2) Use the ping command to send large packet to the NVR, execute the command of “ping 192.168.0.0 -l 1472 -f” (the IP address may change according to the real condition), and check if there exists packet loss.



Simultaneously press **Ctrl** and **C** to exit the ping command.

3. Verify the hardware of the PC is good enough.

Simultaneously press **Ctrl**, **Alt** and **Delete** to enter the windows task management interface, as shown in the following figure.

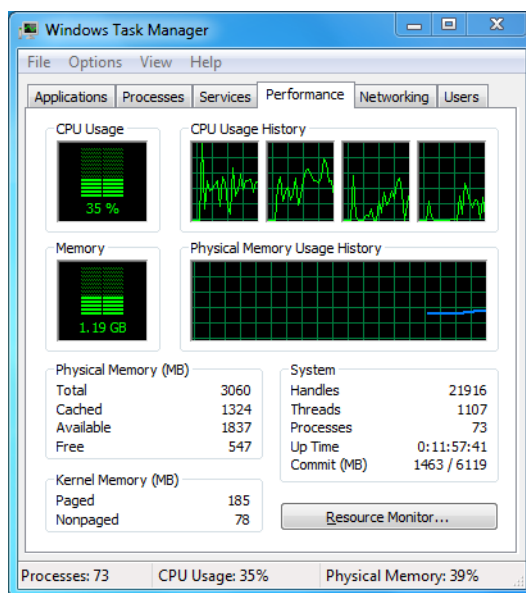

Windows task management interface

- Select the “Performance” tab; check the status of the CPU and Memory.
 - If the resource is not enough, please end some unnecessary processes.
4. Check if the fault is solved by the above steps.

If it is solved, finish the process.

If not, please contact the engineer from our company to do the further process.

- **When using the NVR to get the live view audio, there is no sound or there is too much noise, or the volume is too low.**

Possible Reasons:

- a) Cable between the pickup and IP camera is not connected well; impedance mismatches or incompatible.
- b) The stream type is not set as “Video & Audio”.
- c) The encoding standard is not supported with NVR.

Steps:

1. Verify the cable between the pickup and IP camera is connected well; impedance matches and compatible.

Log in the IP camera directly, and turn the audio on, check if the sound is normal. If not, please contact the manufacturer of the IP camera.

2. Verify the setting parameters are correct.

Select “Menu > Record > Parameters > Record”, and set the Stream Type as “Audio & Video”.

3. Verify the audio encoding standard of the IP camera is supported by the NVR.

NVR supports G722.1 and G711 standards, and if the encoding parameter of the input audio is not one of the previous two standards, you can log in the IP camera to configure it to the supported standard.

4. Check if the fault is solved by the above steps.

If it is solved, finish the process.

If not, please contact the engineer from our company to do the further process.

- **The image gets stuck when NVR is playing back by single or multi-channel.**

Possible Reasons:

- a) Poor network between NVR and IP camera, and there exists packet loss during the transmission.
- b) The frame rate is not the real-time frame rate.
- c) The NVR supports up to 16-channel synchronize playback at the resolution of 4CIF, if you want a 16-channel synchronize playback at the resolution of 720p, the frame extracting may occur, which leads to a slight stuck.

Steps:

1. Verify the network between NVR and IP camera is connected.

1) When image is stuck, connect the RS-232 ports on PC and the rear panel of NVR with the RS-232 cable.

2) Open the Super Terminal, and execute the command of “**ping 192.168.0.0 -l 1472 -f**” (the IP address may change according to the real condition), and check if there exists packet loss.



Simultaneously press the **Ctrl** and **C** to exit the ping command.

2. Verify the frame rate is real-time frame rate.

Select “Menu > Record > Parameters > Record”, and set the Frame Rate to “Full Frame”.

3. Verify the hardware can afford the playback.

Reduce the channel number of playback.

Select “Menu > Record > Encoding > Record”, and set the resolution and bitrate to a lower level.

4. Reduce the number of local playback channel.

Select “Menu > Playback”, and uncheck the checkbox of unnecessary channels.

5. Check if the fault is solved by the above steps.

If it is solved, finish the process.

If not, please contact the engineer from our company to do the further process.

- **No record file found in the NVR local HDD, and prompt “No record file found”.**

Possible Reasons:

- a) The time setting of system is incorrect.
- b) The search condition is incorrect.
- c) The HDD is error or not detected.

Steps:

1. Verify the system time setting is correct.
Select “Menu > Configuration > General > General”, and verify the “Device Time” is correct.
2. Verify the search condition is correct.
Select “Playback”, and verify the channel and time are correct.
3. Verify the HDD status is normal.
Select “Menu > HDD > General” to view the HDD status, and verify the HDD is detected and can be read and written normally.
4. Check if the fault is solved by the above steps.
If it is solved, finish the process.
If not, please contact the engineer from our company to do the further process.

Summary of Changes

Version 3.1.2

Added

1. Support switch to the cloud storage working mode. (Product Key Features)
2. Support 64-window division for 64-ch models. (Chapter 3.3)
3. Support connection to more models of IP camera from third-party manufactures. (List of Compatible IP Cameras)

Updated

1. Optimize the right-click menu; add the PTZ control option in it. (Chapter 3.2.2)
2. Optimize the PTZ control interface and control panel in the live view mode. (Chapter 4)
3. Optimize the smart playback interface, add the playback setting function. (Chapter 6.1.5)
4. The RAID function is supported by DS-9600NI-ST and DS-8600NI-ST. (Chapter 11)

Deleted

1. Combine the smart search function with the smart playback function, and the smart search section is deleted. (Chapter 6.2.2 Smart Search)

Version 3.1.0

Added

1. Support smart IP cameras connection, and VCA alarm and recording are supported. (Chapter 5.2 and Chapter 8.5)
2. Support transfer protocol selection when custom adding and editing IP cameras. (Chapter 2.3.1 and Chapter 2.3.2)
3. Support viewing the real-time frame rate, bitrate, and resolution of added IP camera on the live view interface. (Chapter 3.2.4)
4. Support volume adjusting of live view, playback and two-way audio. (Chapter 3.3)
5. Support adjusting the camera order in live view mode by clicking-and-dragging the window. (Chapter 3.3)
6. Support locking recording file when playback. (Chapter 5.9)
7. Support thumbnail display during playback when clicking the mouse on the process bar. (Chapter 6.1.1 and Chapter 6.1.2)
8. Support volume adjusting of selected camera when playback. (Chapter 6.1.1~Chapter 6.1.4)
9. Support searching and playing back by VCA events. (Chapter 6.1.3)
10. Support smart playback by VCA rules. (Chapter 6.2.2)
11. Support capturing and exporting pictures when playback. (Chapter 7.2)
12. Support virtual host and telnet function. (Chapter 9.2.13 and Chapter 9.2.14)
13. Support disk clone to the eSATA disk. (Chapter 12.6)

Updated

1. Optimize the layout of soft keyboard. (Chapter 1.4)
2. Optimize the control panel of PTZ, adding the configuration shortcut on the panel. (Chapter 4.3)

List of Compatible IP Cameras



- For the list, our company holds right to interpret.
- **ONVIF compatibility** refers to the camera can be supported both when it uses the ONVIF protocol and its private protocols. **Only ONVIF is supported** refers to the camera can only be supported when it uses the ONVIF protocol. **Only AXIS is supported** refers to the function can only be supported when it uses the AXIS protocol.

IP Camera Manufacturer or Protocol	Model	Version	Max. Resolution	Sub-stream	Audio
ACTI	TCM4301-10D-X-00083	A1D-310-V4.12.09-AC	1280×1024	×	√
	TCM5311-11D-X-00023	A1D-310-V4.12.09-AC	1280×960	×	√
	TCM3401-09L-X-00227	A1D-220-V3.13.16-AC	1280×1024	×	×
ARECONT	AV8185DN	65172	1600×1200	×	×
	AV1305M	65175	1280×1024	√	×
	AV2815	65220	1920×1080	√	×
	AV3105M	65175	1920×1080	√	×
AXIS	M1114	5.09.1	1024×640	√	×
	M3011(ONVIF compatibility)	5.21	640×480	√(Only AXIS is supported)	×
	M3014(ONVIF compatibility)	5.21.1	1280×800	√	×
	P3301(ONVIF compatibility)	5.11.2	640×480	√	√(Only AXIS is supported)
	P3304(ONVIF compatibility)	5.20	1280×800	√	√(Only AXIS is supported)
	P3343(ONVIF compatibility)	5.20.1	800×600	√	√(Only AXIS is supported)
	P3344(ONVIF compatibility)	5.20.1	1280×800	√	√(Only AXIS is supported)
	P5532	5.15	720×576	√	×
	Q7404	5.02	720×576	√	√
	P1346	5.40.9.2	2048×1536	√	√
Bosch (ONVIF compatibility)	AutoDome Jr 800HD	39500450	1920×1080	×	√(Only Bosch is supported)
	NBC 265 P	07500452	1280×720	×	√(Only Bosch is supported)
	Dinion NBN-921-P	10500453	1280×720	×	√(Only Bosch is supported)
Brickcom	CB-500Ap (ONVIF	V3.2.1.3	1920×1080	×	√(Only

IP Camera Manufacturer or Protocol	Model	Version	Max. Resolution	Sub-stream	Audio
	compatibility)				Brickcom is supported)
Canon	VB-H410 (ONVIF compatibility)	Ver.+1.0.0	1280*960	×	√
	VB-S9000F	Ver. 1.0.0	1920*1080	×	×
	VB-S300D	Ver. 1.0.0	1920*1080	×	×
	VB-H6100D	Ver. 1.1.0	1920*1080	×	×
	VB-H7100F	Ver. 1.1.0	1920*1080	×	√
	VB-S8000	Ver. 1.0.0	1920*1080	×	×
HUNT	HLC_79AD	V1.0.40	1600×1200	√	×
Hikvision	DS-2CD783F-E(I)	V5.1.0 build 131202	2560×1920	√	√
	DS-2CD886MF-E	V4.0.3 build 120913	2560×1920	√	√
	DS-2CD754F-EI DS-2CD754FWD-EIZ	V5.1.0 build 131202	2048×1536	√	√
	DS-2CD754FWD-E	V5.1.0 build 131202	1920×1080	√	√
	DS-2CD8153F-E	V5.1.0 build 131202	1600×1200	√	√
	DS-2CD7153-E	V5.1.0 build 131202	1600×1200	√	×
	DS-2CD876BF-E	V4.0.3 build 120913	1600×1200	√	√
	DS-2CD876MF-E	V4.0.3 build 120913	1600×1200	√	√
	DS-2CD877BF	V4.0.3 build 120913	1920×1080	√	√
	DS-2CD855F-E	V5.1.0 build 131202	1920×1080	√	√
	DS-2CD852MF-E	V2.0 build 110614	1600×1200	√	√
		V2.0 build 110426			
		V2.0 build 100521			
	DS-2CD862MF-E	V2.0 build 110614	1280×960	√	√
		V2.0 build 110426			
		V2.0 build 100521			
	DS-2CD863PF/NF-E	V5.1.0 build 131202	1280×960	√	√
	DS-2CD7164-E	V5.1.0 build 131202	1280×720	√	×
	DS-2CD2012-I	V5.1.6 build 140412	1280×960	√	×
	DS-2CD2612-I	V5.1.6 build 140412	1280×960	√	×
	DS-2CD2612-IS	V5.1.6 build 140412	1280×960	√	√
	DS-2CD2612-IS	V5.1.6 build 140412	1280×960	√	√
	DS-2CD2410FD-I(W)	V5.1.6 build 140412	1280×720	√	√
DS-2CD2132-I	V5.1.6 build 140412	2048×1536	√	×	
DS-2CD2632-I	V5.1.6 build 140412	2048×1536	√	×	
DS-2CD2632-IS	V5.1.6 build 140412	2048×1536	√	√	
DS-2CD2710F-I	V5.1.6 build 140412	2048×1536	√	√	

IP Camera Manufacturer or Protocol	Model	Version	Max. Resolution	Sub-stream	Audio
	DS-2CD2720F-I	V5.1.6 build 140412	2048×1536	√	×
	DS-2CD4012F	V5.1.6 build 140412	1280×960	√	√
	DS-2CD4312F-I	V5.1.6 build 140412	1280×960	√	×
	DS-2CD4212F-I(2.8-12mm)	V5.1.6 build 140412	1280×960	√	×
	DS-2CD6213F	V5.1.0 build 131202	1280×960	√	×
	DS-2CD6223F	V5.1.0 build 131202	1920×1080	√	×
	DS-2CD4124F-I(2.8-12mm)	V5.1.6 build 140412	1920×1080	√	√
	DS-2CD4324F-I	V5.1.6 build 140412	1920×1080	√	×
	DS-2CD4224F-I	V5.1.6 build 140412	1920×1080	√	×
	DS-2CD4026FWD	V5.1.6 build 140412	1920×1080	√	√
	DS-2CD4232FWD-IS(2.8-12mm)	V5.1.6 build 140412	2048×1536	√	√
	DS-2CD4232FWD-I	V5.1.6 build 140412	2048×1536	√	×
	DS-2CD4332FHWD-I	V5.1.6 build 140412	2048×1536	√	×
	DS-2CD4332FWD-I	V5.1.6 build 140412	2048×1536	√	×
	DS-2CD4212FWD-IS	V5.1.6 build 140412	2048×1536	√	√
	DS-2CD4312FWD-I	V5.1.6 build 140412	2048×1536	√	×
	DS-2CD4026FWD-SDI	V5.1.6 build 140412	2048×1536	√	√
	DS-2CD4212FWD-I	V5.1.6 build 140412	2048×1536	√	×
	DS-2CD6233F	V5.1.0 build 131202	2048×1536	√	×
	DS-2CD802NF	V2.0 build 090522	704×576	√	√
		V2.0 build 090715			
		V2.0 build 110301			
	DS-2CD9121	V3.4.2 build 130718	1600×1200	×	×
	iDS-2CD9121A	V3.5.0 build130906	1600×1200	×	×
	DS-2CD9122	V3.5.0 build131012	1920×1080	×	×
	DS-2CD9122-H	V3.5.0 build131018	1920×1080	×	×
	DS-2CD9131	V3.6.1 build140103	2048×1536	√	×
	iDS-2CD9151A	V3.6.1 build140103	2448×2048	×	×
	iDS-2CD9151A-E	V3.7.0 build140403	2448×2048	√	×
	DS-2CD9182-H	V3.7.0 build140403	3296×2472	√	×
	DS-2CD9152	V3.5.0 build131012	2560×1920	×	×
	iDS-2CD9152-H	V3.6.1 build140103	2592×2048	√	×
	iDS-2CD9282	V3.5.0 build130810	3296×2472	×	×
	DS-2CD9131-K	V3.7.0 build140403	2048×1536	√	×
	DS-2CD9152-HK	V3.7.0 build140403	2592×2048	√	×
	DS-2CD9120-H	V3.6.1 build140103	1600×1200	×	×
	DS-2CD966 (B) DS-2CD966-V(B)	V3.1.0 build120423	1360×1024	×	×
	DS-2CD976(C)	V3.1.0 build120423	1600×1200	×	×

IP Camera Manufacturer or Protocol	Model	Version	Max. Resolution	Sub-stream	Audio
	DS-2CD976-V(C)				
	DS-2CD977(C)	V3.1.0 build 120423	1920×1080	×	×
	DS-2CD986A(C)	V3.1.0 build120423	2448×2048	×	×
	DS-2CD986C(B)	V2.3.6 build 120401	2560×1920	×	×
	DS-2DM7274-A	V5.1.6 build 140417	1280×960	√	√
	DS-2DF7284-A/D/AF	V5.1.6 build 140417	1920×1080	√	√
	DS-2DE7174-A/AE/D	V5.1.6 build 140328	1280×960	√	√
	DS-2DE7186-A/AE	V5.1.6 build 140328	1920×1080	√	√
	DS-2DF1-518	V3.2.0 build131223	704×576	√	√
	DS-2DF1-402	V3.2.0 build131223	704×576	√	√
	DS-2ZCN3006	V5.1.6 build140409	1280×960	√	√
	DS-2ZCN3007	V5.1.6 build140409	1920×1080	√	√
	DS-6501HFI DS-6502HFI DS-6504HFI	V1.0.1 build130607	704×576	√	√
	DS-6501HFI-SATA DS-6502HFI-SATA DS-6504HFI-SATA	V1.0.1 build130607	704×576	√	√
	DS-6508HFI DS-6516HFI	V1.0.1 build130607	704×576	√	√
	DS-6508HFI-SATA DS-6516HFI-SATA	V1.0.1 build130607	704×576	√	√
	DS-6501HCI DS-6502HCI DS-6504HCI	V1.0.1 build130607	704×576	√	√
	DS-6501HCI-SATA DS-6502HCI-SATA DS-6504HCI-SATA	V1.0.1 build130607	704×576	√	√
	DS-6508HCI DS-6508HCI-SATA	V1.0.1 build130607	704×576	√	√
	DS-6516HCI DS-6516HCI-SATA	V1.0.1 build130607	704×576	√	√
	DS-6601HCI DS-6602HCI DS-6604HCI	V1.2.1 build131202	704×576	√	√
	DS-6601HFI DS-6602HFI DS-6604HFI	V1.2.1 build131202	704×576	√	√
	DS-6601HFHI DS-6601HFHI/L	V1.2.1 build131202	1920×1080	√	√

IP Camera Manufacturer or Protocol	Model	Version	Max. Resolution	Sub-stream	Audio
Panasonic	WV-SF336H	Application:1.06 Image data: 1.06	1280×960	√	√
	WV-SP306H (ONVIF compatibility)	Application:1.34 Image data:1.06	1280×960	√(Only Panasonic is supported)	√
PELCO (ONVIF compatibility)	D5118	1.8.2-20120327- 2.9310-A1.7852	1280×960	√	×
	IXE20DN-AAXVUU2	1.8.2-20120327- 2.9081-A1.7852	1920×1080	√	×
	IX30DN-ACFZHB3	1.8.2-20120327- 2.9080-A1.7852	2048×1536	√	×
SAMSUNG (ONVIF compatibility)	SNB-5080	V3.10_130416	1280×1024	√	√
SANYO	VCC-HD2300P	2.03-02(110318-00)	1920×1080	×	×
	VCC-HD2500P	2.02-02(110208-00)	1920×1080	×	√
	VCC-HD4600P	2.03-02(110315-00)	1920×1080	×	√
SONY	SNC-CH220	1.50.00	1920×1080	×	×
	SNC-RH124 (ONVIF compatibility)	1.79.00	1280×720	√	√
	SNC-EP580 (ONVIF compatibility)	1.53.00	1920×1080	√	√
	SNC-DH220T (Only ONVIF is supported)	1.50.00	2048×1536	×	×
Vivotek	IP7133	0203a	640×480	×	×
	FD8134 (ONVIF compatibility)	0107a	1280×800	×	×
	IP8161 (ONVIF compatibility)	0104a	1600×1200	×	√
	IP8331 (ONVIF compatibility)	0102a	640×480	×	×
	IP8332 (ONVIF compatibility)	0105b	1280×800	×	×
ZAVIO (ONVIF compatibility)	D5110	MG.1.6.03P8	1280×1024	√(Only ZAVIO is supported)	×
	F3106	M2.1.6.03P8	1280×1024	√(Only ZAVIO is supported)	√
	F3110	M2.1.6.01	1280×720	√(Only ZAVIO is	√

IP Camera Manufacturer or Protocol	Model	Version	Max. Resolution	Sub-stream	Audio
				supported	
	F3206	MG.1.6.02c045	1920×1080	√(Only ZAVIO is supported	√
	F531E	LM.1.6.18P10	640×480	√(Only ZAVIO is supported	√

DS-7732NI-SP

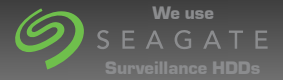

The DS-7732NI-SP are Hikvision's 32 channel NVR equipped with a fantastic integrated 16 channel PoE switch, not only does this save you money in separate power supplies but it can make each install a breeze with plug and play. Simply plug in your Hikvision camera in to the switch and the NVR will automatically find the camera and configure it for use, it couldn't be easier. Other great features include up to 5 Megapixel recording, 2 way audio and up to 32 channels at once with a recording bandwidth of 200Mbps. Offering connectivity from almost any device including Apps for Windows, Mac, Iphone and Android the DS-7732NI-SP are a perfect choice for almost any install.

FEATURES:

- Third-party network cameras supported
- Up to 5MP resolution recording
- HDMI and VGA output at up to 1920 x 1080P resolution
- Plug & Play with 16 independent PoE network interfaces
- 4 SATA HDD interface up to 4TB each
- HDD quota and group management
- Push notification
- 16 alarm inputs, 4 alarm outputs

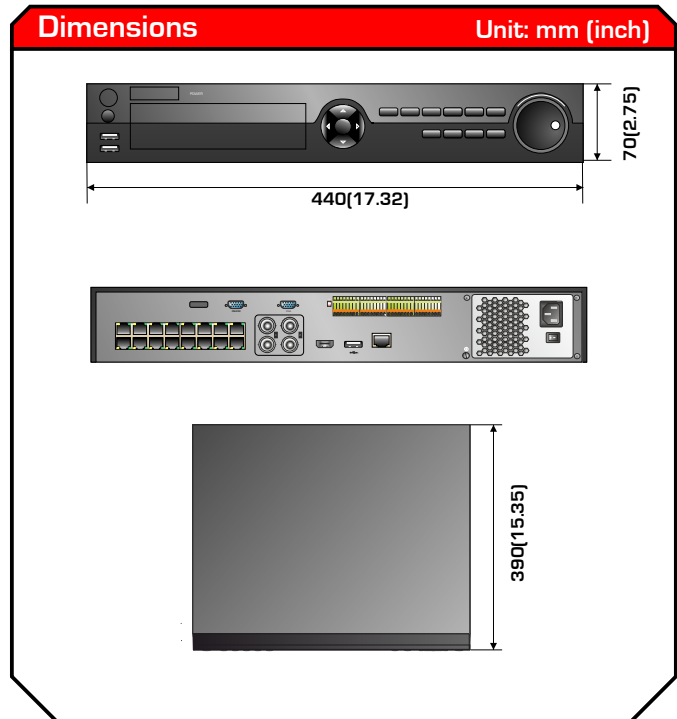

DS-7732NI-SP	
VIDEO / AUDIO INPUT	
IP Video Input	32-ch
Two-Way Audio Input	1-ch, BNC (2.0Vp-p, 1kΩ)
Incoming Bandwidth	200Mbps
VIDEO / AUDIO OUTPUT	
Recording Resolution	5MP/3MP/1080P/UXGA/720P/VGA/4CIF/DCIF/2CIF/CIF/QCIF
CVBS	1-ch, BNC (1.0 Vp-p, 75 Ω) Resolution: 704 x 576 (PAL)
HDMI Output	1920 x 1080P / 60Hz, 1920 x 1080P / 50Hz, 1600 x 1200 / 60Hz, 1280 x 1024 / 60Hz, 1280 x 720 / 60Hz, 1024 x 768 / 60Hz
VGA Output	1920 x 1080P / 60Hz, 1600 x 1200 / 60Hz, 1280 x 1024 / 60Hz, 1280 x 720 / 60Hz, 1024 x 768 / 60Hz
Audio Output	2-ch, BNC (Linear, 600Ω)
Playback Resolution	5MP / 3MP / 1080P / UXGA / 720P / VGA / 4CIF / DCIF / 2CIF / CIF / QCIF
Synchronous Playback	16-ch
HARD DISK	
SATA	4 SATA interfaces for 4 HDDs
eSATA	1 eSATA interface
Capacity	Up to 4TB capacity for each HDD
EXTERNAL INTERFACE	
Network Interface	1 RJ-45 10 / 100 / 1000 Mbps self-adaptive Ethernet Interface 16 independent 100 Mbps PoE network interfaces
Serial Interface	1 RS-232 interface (for parameters configuration, maintenance, transparent channel); 1 RS-485 interface (reserved); 1 RS-485 keyboard interface (for special keyboard control)
USB Interface	3 x USB 2.0
Alarm In/Out	16/4
GENERAL	
Power Supply	100~240VAC, 6.3A, 50~60Hz
Consumption	≤ 45 W
Working Temperature	-10°C ~ +55°C
Working Humidity	10% ~ 90%
Chassis	19-inch rack-mounted 1.5U chassis
Dimensions (WxHxD)	440 x 70 x 390mm (17.32" x 2.75" x 15.35")
Weight	≤ 8 Kg (17.64 lb) (without hard disk)

