

**High Resolution
Super DNR III
Vandal Resistant
Dome Camera**

User's Manual

[DC 12V Only]

W6

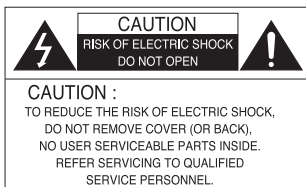



The lightning flash with an arrowhead symbol, within an equilateral triangle is intended to alert the user to the presence of uninsulated dangerous voltage within the product's enclosure that may be of sufficient magnitude to constitute a risk of electric shock to persons.



The exclamation point within an equilateral triangle is intended to alert the user to the presence of important operating and maintenance (servicing) instructions in the literature accompanying the appliance.

INFORMATION - This equipment has been tested and found to comply with limits for a Class A digital device, pursuant to part 15 of the FCC Rules. These limits are designed to provide reasonable protection against harmful interference when the equipment is operated in a commercial environment. This equipment generates, uses, and can radiate radio frequency energy and, if not installed and used in accordance with the instruction manual, may cause harmful interference to radio communications. Operation of this equipment in a residential area is likely to cause harmful interference in which case the user will be required to correct the interference at his own expense.

WARNING - Changes or modifications not expressly approved by the manufacturer could void the user's authority to operate the equipment.

CAUTION : To prevent electric shock and risk of fire hazards:

- ◆ Do NOT use power sources other than that specified.
- ◆ Do NOT expose this appliance to rain or moisture.

This installation should be made by a qualified service person and should conform to all local codes.

■ Contents

Features	04
Warning	05
Precautions	06
Components	08
Names and Functions of Parts	09
■ Lens	10
■ OSD	10
■ Spot Monitor	11
■ 3Axis Bracket	11
■ SMPS	11
■ UTP	11
Dimension	11
Installation & Cable Connection	12

How to Use the Camera

■ Set up Menu	14
■ How to Set up the Functions	15
• LENS	16
• EXPOSURE	18
• WHITE BALANCE control	21
• BACKLIGHT	22
• DNR 3 (Digital Noise Reduction)	24
• DAY/NIGHT	25
• SPECIAL	26
• PROFILE	31
• EXIT	33

Troubleshooting	34
-----------------------	----

Specifications	35
----------------------	----

■ Features

High Resolution

By adopting a diagonal 6mm (1/3") 520K pixel(NTSC), 610K pixel(PAL) Color Double Density the camera produces clear picture quality with a horizontal resolution of 650 TV lines in color and 700TV lines in B/W.

Excellent Sensitivity

Adopting a Diagonal 6mm (1/3"), highly sensitive CCD and digital signal processing technology, it can clearly distinguish the outline and color of a subject in an extremely low luminance environment . even, for example, under starlight. Since surveillance is possible in places where the light is poor, the camera is appropriate for day and night surveillance outdoors or on the outside of buildings.

DNR3 (Digital Noise Reduction)

The amount of low luminance noise has been significantly reduced, and the signal-to-noise ratio (S/N ratio) as well as horizontal resolution have been improved, resulting in a clear and sharp image display even in the dark.

Motion Detection

Since the camera detects motion and generates signals without any additional external sensors, you can monitor activity more efficiently by connecting the camera to an alarm device.

DIS (Digital Image Stabilizer)

The DIS function compensates for any camera movement, to produce more stable pictures.

Day & Night

The camera identifies whether it is day or night and automatically switches to the appropriate mode, depending on its environment. By day, the camera switches to color mode in order to maintain optimal color. At night, it switches to B/W mode so as to obtain better picture definition.

Miscellaneous Functions

HLC(High Light Compensation), SENS-UP, REVERSE , D-ZOOM, SHARPNESS and PRIVACY functions are provided.

PROFILE

You can set a mode according to the camera installation conditions.

- BASIC, DAYNIGHT, BACKLIGHT, ITS, INDOOR, USER

OSD

The camera's OSD is complimented by 18 languages.

- NTSC : English, Korean, Japanese, Spanish, French, Portuguese, Taiwanese

- PAL : English, Chinese, German, Italian, French, Spanish, Russian, Czech, Polish, Romanian, Serbian, Swedish, Danish, Turkish, Portuguese, Thai

■ Warning

The camera needs periodic inspection.

Contact an authorized technician for inspection.

Stop using your camera when you find a malfunction.

If you use your camera around smoke or unusual heat for a long time, fire may be caused.

Do not install the camera on a surface that can not support it.

Unless the surface is suitable, it could cause falling or other hazards.

Do not hold plug with wet hands.

It could cause an electric shock.

Do not disassemble the camera.

It may result in fire, electric shock or other hazards.

Do not use the camera close to a gas or oil leak.

It may result in fire or other hazards.

■ Precautions

Do not install the camera in extreme temperature conditions.



Only use the camera under conditions where temperatures are between -10°C and $+50^{\circ}\text{C}$. Be especially careful to provide ventilation when operating under high temperatures.

Do not install or use the camera in an environment where the humidity is high.



It can cause the image quality to be poor.

Do not install the camera under unstable lighting conditions.



Severe lighting change or flicker can cause the camera to work improperly.

Do not touch the front lens of the camera.



It is one of the most important parts of the camera. Be careful not to be stained by fingerprint.

Do not drop the camera or subject it to physical shocks.



It can cause malfunctions to occur.

Never keep the camera face to strong light directly.

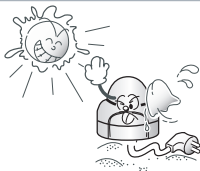

It can damage the CCD.

Do not expose the camera to radioactivity.

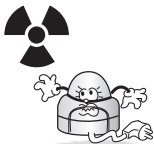

If it is exposed to radioactivity,
For heated CCD, it will be out of
order.



Note

- If the camera is exposed to spotlight or object reflecting strong light, smear or blooming may occur.
- Please check that the power satisfies the normal specification before connecting the camera.

■ Components

1. VANDAL DOME CAMERA

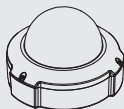

2. SCREWS

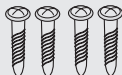

3. WRENCH

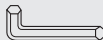

4. EXTRA DC PLUG

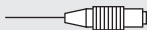

5. BNC FOR VBS - EXTRA



6. INSTRUCTION GUIDE



Names and Functions of Parts ■

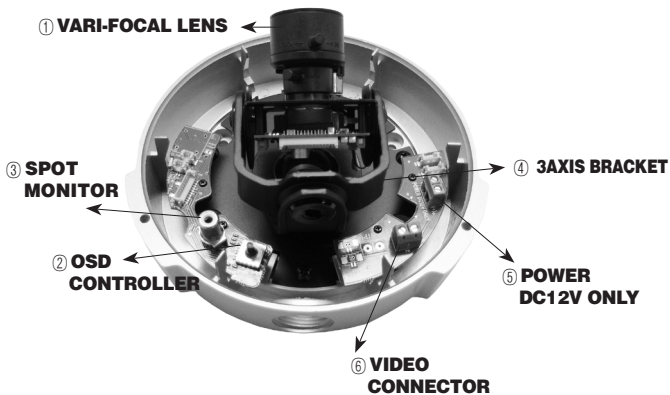

■ Names and Functions of Parts

① LENS : Vari-Focal Auto Iris Lens

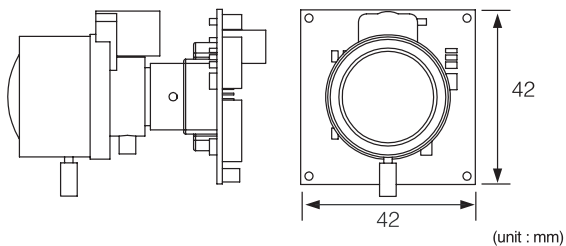

② OSD Controller

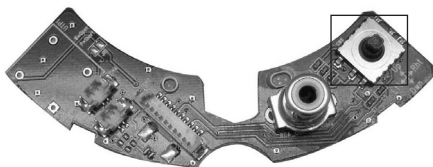

● Control OSD Menu Using the Joystick

Names and Functions of Parts ■

③ RCA Jack for a Spot Monitor

Installers can check the video output through a portable monitor at the sight .

④ 3AXIS BRACKET

Accomplish wall & Ceiling Mount

⑤ POWER DC12V ONLY

⑥ VIDEO CONNECTOR

Dimension ■

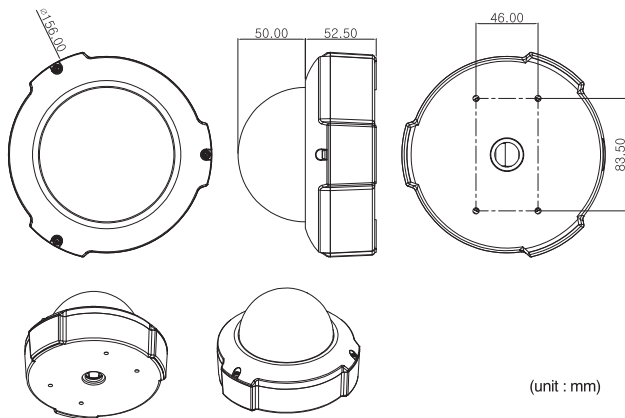

1. Dome Base Mounting

- Open the dome cover by unscrewing 3 screws using special wrench provided.
- Mount the base of camera to a sturdy surface using 4 screws (1.5 inch) and 4 premade holes on the base of the dome.

2. Power Connect & Monitor Impedance

- DC 12V/500mA regulated power supply (DC12V only)
- To avoid fire or shock hazard, must use a UL listed power supply.
- Set the monitor impedance switch to 75Ω. Check the impedance switch when the screen turns blurred.

3. Camera Module Adjustment

- Loosen screws for 3-axis camera bracket and adjust the direction and angle of camera.
- Make sure to retighten the screws for camera bracket.
- Set any function you wish to activate by using the OSD buttons.

4. Dome Cover Mounting

- Replace the dome cover to the base and tighten 3 screws.

Cable Connection ■

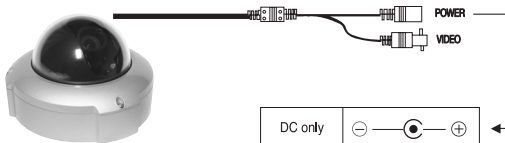

■ How to Use the Camera

Setup Menu

Setup Menu	
LENS	• DC • MANUAL
EXPOSURE	• BRIGHTNESS • SHUTTER • AGC • SENS-UP • RETURN
SSDR	• ON • OFF
WHITE BALANCE	• ATW • OUTDOOR • INDOOR • MANUAL • AWC • SET
BACKLIGHT	• OFF • USERBLC • HLC
DNR3	• ON • OFF
DAY/NIGHT	• AUTO • EXTERN • COLOR • B/W
SPECIAL	• IMAGE ADJ • CAM TITLE • SYNC • MOTION • PRIVACY • DIS • PROFILE • COMM ADJ • RETURN
EXIT	• SAVE • NOT SAVE • RESET

How to Set up the Functions

You can set up function using the Joystick on the OSD Board.

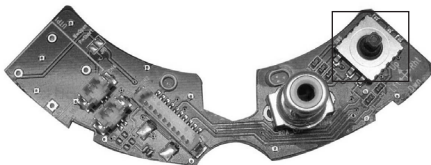

1. Press the SET button.

ï Main setup menu is displayed on the monitor screen.

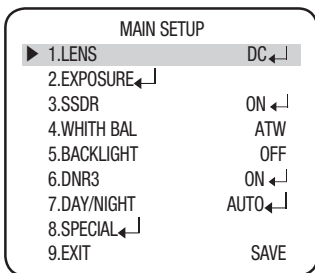

2. Select a desired function using the Joystick.

ï Place the cursor over a desired item.

■ How to Use the Camera

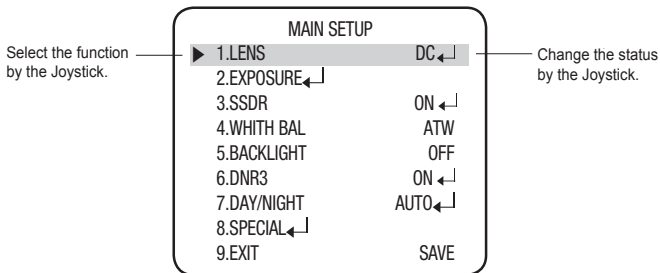

3. Set up a selected item by using the Joystick.
4. To finish the setting, select 'EXIT' and press the Joystick.



Note

- An item with the ◀ icon also has sub menus. To select a sub menu, select an item with the icon and press the Joystick.
- An item with the --- icon is unavailable due to function settings.

LENS

Using this function, you can control the screen brightness.

1. When the SETUP menu screen is displayed, select 'LENS' by using the Joystick so that the arrow indicates 'LENS'.
2. Select the connected lens type by using the Joystick.

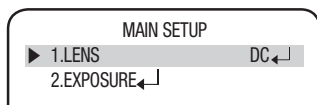

- DC/Video : Select Auto Iris Lens.
You can adjust the minimum shutter and maximum value of ESC shutter mode when DC Lens mode is selected.
 - Manual : Select Manual Lens.
3. Each Lens mode has sub menu site as listed below.
- Brightness (DC, Manual) : Adjusts the video brightness.
 - FOCUS ADJ : To adjust the lens focus correctly, you must activate the Focus Settings mode under each lens menu. To activate the Focus Settings mode, adjust the lens focus, and then deactivate the settings mode.
 - IRIS SPEED (DC) : Adjusts the Iris control speed of the DC lens. If the control speed is too slow or fast, please use this menu to adjust the speed.



Note

- The brightness of the screen can be adjusted in DC mode. The brightness can be adjusted within the range of 1 ~ 70. The optimum level of brightness for the user can be achieved by adjustment. □ default □ 2 □
- If you select the MANUAL mode, it can be adjusted in ESC mode.

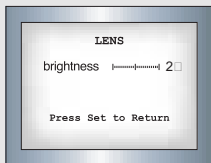

■ How to Use the Camera

EXPOSURE

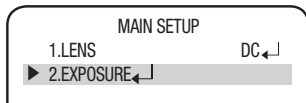

1. When the SETUP menu screen is displayed, select 'EXPOSURE' by using the Joystick so that the arrow indicates 'EXPOSURE'.
2. Select a desired mode using the Joystick.

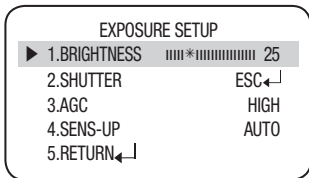

- BRIGHTNESS : Adjusts the video brightness.
- SHUTTER : You can select the shutter.
 - ESC : Select this to control the shutter speed automatically. If ESC is selected, the shutter speed is automatically controlled depending on the ambient illumination of the subject.
 - MANUAL : You can control shutter speed manually.
(NTSC MODEL - 1/60sec~1/120,000sec, PAL MODEL-1/50sec~1/120,000sec)
- A.FLK : Select this when you experience picture flicker, this happens when there is a clash with the installed lighting frequency.
- --- : Shutter speed is fixed at 1/60 sec (1/50 sec).



Note

- When you use a DC lens, set the shutter mode to --- if color rolling occurs.
- When the SHUTTER is set to ESC after selecting the Internal Synchronization Type, the picture may become unstable if the camera faces a bright fluorescent light. Therefore, take care when choosing the installation position.



Note

- When the SHUTTER is set to ESC after selecting the Internal Synchronization Type, the picture may become unstable if the camera faces a bright fluorescent light. Therefore, take care when choosing the installation position.
- ESC and MANUAL modes are only available together when the lens is set to MANUAL.
- When the SHUTTER is set to MANUAL or A.FLK mode, SENS-UP will be disabled.

- AGC(AUTO GAIN CONTROL) : The higher the gain level, the brighter the screen - but the greater the noise.
 - OFF : Deactivates the AGC function.
 - LOW : Allows automatic gain control from 5.3dB to 32dB.
 - HIGH : Allows automatic gain control from 5.3dB to 37dB.
- SENS-UP : When it is night or dark, the camera automatically detects the light level and maintains a clear picture if this mode is activated.
 - OFF : Deactivates the SENS-UP function.
 - AUTO : Activates the SENS-UP function.



Note

- If you set the Function Setup button to 'AUTO' mode, You can adjust the brightness by increasing or decreasing the shutter speed. (x2 ~ x512)
 - Note that the higher the zoom level, the brighter the screen, but the more likely it is that an after-image will appear.
 - Although Noise, Spots, and Whitish symptoms may occur in SENS-UP operation when the zoom level is increased, this is normal.
-
- RETURN : Select this to save the changes in the EXPOSURE menu and return to the SETUP menu.

■ How to Use the Camera

SSDR(Select Super Dynamic Range)

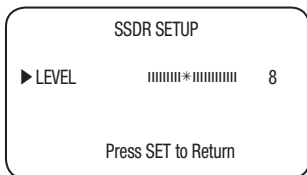

SSDR illuminates darker areas of an image while retaining the same light level for brighter areas to even out the overall brightness of images with high contrast between bright and dark areas. Use the Function Setup switch to change the SSDR level in the sub menu according to the contrast between bright and dark areas.

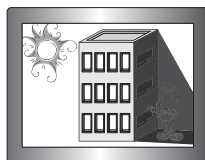
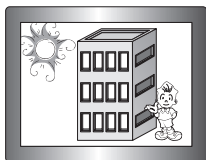

White Balance (White Bal.)

Use the White Balance function to adjust the screen color.

1. When the SETUP menu screen is displayed, select 'White Bal.' by using the Up and Down buttons so that the arrow indicates 'White Bal.'
2. Select a desired mode using the Joystick.

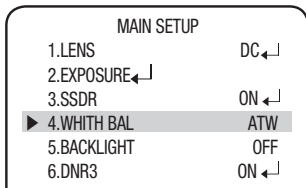

※ [Select one of the following 5 modes, as appropriate for your purpose.

- **ATW** : Select this when the color temperature is between 1,700°K and 11,000°K.
- **OUTDOOR** : Select this when the color temperature is between 1,700°K and 11,000°K. (sodium light inclusion)
- **INDOOR** : Select this when the color temperature is between 4,500°K and 8,500°K.
- **MANUAL** : Select this to fine-tune White Balance manually. Set White Balance first by using the ATW or AWC mode. After that button to MANUAL mode, finetune the White Balance and the Function Setup button.
- **AWC→SET** : To find the optimal luminance level for the current environment, point the camera towards a sheet of white paper and press the Function Setup button. If the environment changes, readjust it.

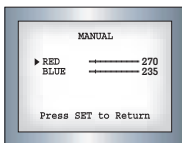

How to Use the Camera



Note

- White Balance may not work properly under the following conditions. In this case select the AWC mode.
 - ① When the color temperature of environment surrounding the subject is out of the control range (e.g. clear sky, or sunset)
 - ② When the ambient illumination of the subject is dim.
 - ③ If the camera is directed towards a fluorescent light or is installed in a place where illumination changes dramatically, the White Balance operation may become unstable.

BACKLIGHT

This camera is designed so that it delivers a distinctive subject and background at the same time, even when the subject is in backlight, unlike conventional cameras, by adopting a proprietary W6 DSP chip.

1. When the SETUP menu screen is displayed, select 'BACKLIGHT' by using the Joystick so that the arrow indicates 'BACKLIGHT'.

MAIN SETUP	
1.LENS	DC←↓
2.EXPOSURE←↓	
3.SSDR	ON←↓
4.WHITH BAL	ATW
▶ 5.BACKLIGHT	OFF
6.DNR3	ON←↓
7.DAY/NIGHT	AUTO←↓
8.SPECIAL←↓	
9.EXIT	SAVE

2. Select a desired mode using the Joystick depending on the camera purpose.

- OFF : Not being used.
- USER BLC : Enables a user to select a desired area on a picture and view that area more clearly.
 - LEVEL : Adjusts the brightness level of a monitoring area.
 - TOP/BOTTOM/LEFT/RIGHT : Adjust the area to be enhanced.

- HIC (High light Compensation) :

This function masks the strong light to minimize white out due to over exposure and preserve much of the on-screen details when the camera aims a strong light source.

- LEVEL : Adjusts the brightness level of a monitoring area.
- LIMIT : Enable to change the operating condition.
- MASK COLOR/TONE : Change the color / brightness of the masking area. (Black,Red, Blue, Cyan, Magenta)
- TOP/BOTTOM/LEFT/RIGHT : Adjust the area to be enhanced.

HLC SETUP	
▶ 1. LEVEL	MIDDLE
2. LIMIT	NIGHT ONLY
3. MASK COLOR	BLACK
4. MASK TONE	* 5
5.TOP	* 10
6.BOTTOM	* 120
7.LEFT	* 10
8.RIGHT	* 210
9. RETURN	←
Press SET to Return	

■ How to Use the Camera

DNR3

This function reduces the background noise in a low luminance environments.

1. When the SETUP menu screen is displayed, select 'DNR3' by using the Joystick so that the arrow indicates 'DNR3'.
2. Select a desired mode using the Function Setup switch.
 - OFF : Deactivates DNR3 so that noise is not reduced.
 - ON : Activates DNR3 so that noise is reduced.
3. Set the DNR3 mode to 'ON' and press the Joystick.
Then you can adjust the noise reduction level.

MAIN SETUP		
1.LENS		DC
2.EXPOSURE		
▶ 3.SSDR		
4.WHITH BAL		ATW
5.BACKLIGHT		OFF
6.DNR3		ON←

DNR3		
▶ LEVEL	*	15
Press SET to Return		

Note

- You cannot set the DNR3 to 'ON' or 'OFF' when the AGC mode of the EXPOSURE menu is 'OFF'.
- When adjusting the noise reduction level of the DNR3 mode, remember that the higher the level set, the more the noise level will be reduced but that after image may also occur.

DAY / NIGHT

You can display pictures in color or black and white.

- When the SETUP menu screen is displayed, select 'DAY/NIGHT' by using the Joystick so that the arrow indicates 'DAY/NIGHT'.
- Select a desired mode using the Joystick according to the picture display you want.
 - **AUTO** : The mode is switched to 'Color' in a normal environment, but switches to 'B/W' mode when ambient illumination is low. To set up the switching time for AUTO mode, press the Joystick. You can turn on or off the burst signal on B/W mode.

- **BURST MODE** : You can turn on or off the burst signal on B/W mode.
- **DWELL TIME** : You can select the duration time about changing the day/night mode.
→3s, 5s, 7s, 10s, 15s, 20s, 30s, 40s, 60s
- **DURATION** : You can select the brightness level at which the camera switches from day to night mode.

	Color → B/W	B/W → Color
Fast	2.5 lux	5 lux
Slow	1 lux	7 lux

※ Light levels are often site dependant.

- **EXTERN** : This mode allows you to apply a desired filter to external signals.
- **COLOR** : The picture is always displayed in color.
- **B/W** : The picture is always displayed in black and white. You can turn on or off the burst signal on B/W mode.



Note

- When AGC in the EXPOSURE menu is 'OFF', '-' mode operates as selecting 'COLOR' mode and 'AUTO' mode cannot be selected.
- The OSD key does not work for 3 seconds when switching to Color or B/W, to ensure stable camera operation.

MAIN SETUP

1.LENS	DC ↵
2.EXPOSURE	
3.SSDR	
4.WHITH BAL	ATW
5.BACKLIGHT	OFF
6.DNR3	ON ↵
▶ 7.DAY/NIGHT	AUTO ↵

AUTO SETUP

▶ 1.BURST MODE	ON
2.COLOR→B/W	
DURATION	FAST
DWELL TIME	5 SEC
3.B/W→COLOR	
DURATION	FAST
DWELL TIME	5 SEC
4.RETURN ↵	

■ How to Use the Camera

SPECIAL

1. When the SETUP menu screen is displayed, select 'SPECIAL' by using the Joystick so that the arrow indicates 'SPECIAL'.

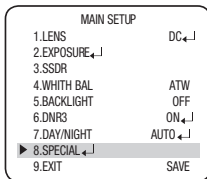

2. Select a desired mode using the Joystick.

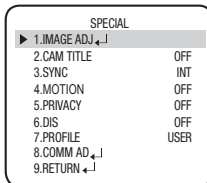

- IMAGE ADJ :

- 1) When the SPECIAL menu screen is displayed, select 'IMAGE ADJ' by using the Joystick so that the arrow indicates 'IMAGE ADJ'.
- 2) Select a desired mode using the Joystick.

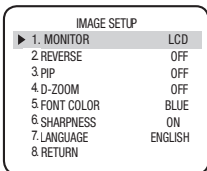

- **Monitor** : Please change the settings value of video appropriate to your monitor.

- **LCD** : Please select this menu item when using an LCD monitor.

You can change the gamma, PED level and color gain in the sub menus.

- **CRT** : Please select this menu item when using a CRT monitor.
You can change the PED level, color gain in the sub menus.
 - **USER** : Please use this menu item when using a monitor other than standard ones. You can change the gamma, PED level and color gain in the sub menus.

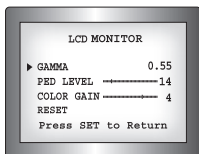

- **REVERSE** : You can reverse the picture.

- **OFF** : You don't reverse the picture.
 - **H-REV** : You can flip the picture horizontally on the screen.
 - **V-REV** : You can flip the picture vertically on the screen.
 - **HV-REV** : You can flip the picture horizontally and vertically on the screen.

- **PIP(Picture in Picture)** : Displays a full-size image along with the thumbnail to provide more detailed information. The position of the thumbnail is adjustable.

- **D-ZOOM** : You can use a digital zoom of x1 ~ x16.

- **FONT COLOR** : You can change the OSD font color.

(White, Yellow, Green, Red, Blue)

- **SHARPNESS** : As you increase this value, the picture outline becomes stronger and clearer. Adjust this value appropriately depending on the sharpness of the picture.

- **LANGUAGE** : You can select the menu language according to your requirements.

- **NTSC** : Korean, English, French, Spanish, Japanese, Portuguese
 - **PAL** : English, Chinese, German, Italian, French, Spanish, Russian, Czech, Polish, Romanian, Serbian, Swedish, Danish, Turkish, Portuguese, Thai

- **RETURN** : Select this to save the settings for the IMAGE ADJ menu and to return to the SPECIAL menu.

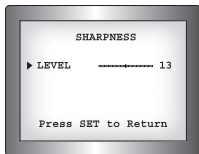
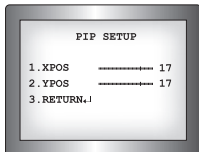

Note

- When the V-REV or H-REV mode is enabled, the text on the screen does not flip.
- If you increase the SHARPNESS level too high, the picture may become distorted or noise may appear.



Note

- When using AC power at 60Hz(NTSC), 50Hz(PAL) frequency, you can use the LL type synchronization.(Do not Input AC to DC Type camera)
- When the power is DC 12V, the SYNC menu is fixed to the 'INT' mode.

• MOTION DET : Commands the camera to motion-detect and trace an object.

1. If the SPECIAL menu screen is displayed, use the Function Setup switch so that the arrow indicates 'MOTION DET'.
2. Set it to 'ON' by using the Function Setup switch.

MOTION DET	
▶ 1. DETECT BOX	ON
2. ALARM OUT	OFF
3. DETECT AREA	←↓
4. MASK AREA	←↓
5. SENSITIVITY	* 3
6. DET.SIZE	* 3
7. RETURN	←↓

- DETECT BOX : Outlines an object on the screen in a box when its movement matches a custom Motion Type.

- ALARM OUT : Releases a signal from the MD Output Terminal of the camera when an object's movement matches a custom Motion Type.

- DETECT AREA : Defines the Motion Detection area.

- MASK AREA : Specify a detection exception area to mask.
Select a mask area number and specify the size and position.

- ▶ AREA : You can select up to 4 areas.
- ▶ MODE : Determines whether to use the area selected in the AREA.

▶ TOP / BOTTOM / LEFT / RIGHT :
Adjust the size and position of the selected area.

▶ RETURN : Select this to save the MASK AREA menu settings and return to the INTELLIGENCE menu.

• SENSITIVITY : Set the sensitivity of the motion detection.
When adjusting the sensitivity, note that the lower the level means the higher sensitivity.

DETECT AREA	
1. TOP	* 1
2. BOTTOM	*50
3. LEFT	* 1
4. RIGHT	*50
5. RETURN	←↓

MASK AREA	
▶ 1. AREA	AREA1
2. MODE	OFF
3. TOP	* 30
4. BOTTOM	* 110
5. LEFT	* 25
6. RIGHT	* 110
7. RETURN	←↓

■ How to Use the Camera

- **DET. SIZE** : Selects an object size to detect on the screen. When adjusting the detection size, note that the higher the level means the bigger detection size.
- **RETURN** : Select this to save the INTELLIGENCE menu settings and return to the SPECIAL menu.

- **PRIVACY** : Mask an area you want to hide on the screen,

1 When the SPECIAL menu screen is displayed, press the Joystick so that the arrow indicates 'PRIVACY'.

2 Set up the mode using the Function Setup switch.

- **AREA** : You can select up to 12 PRIVACY areas.
- **MODE** : Determines whether to use the area selected in the AREA SEL.
- **MASK COLOR** : Determine area color. You can select GREEN, RED, BLUE, BLACK, WHITE and GRAY.
- **TRANSPARENCY** : Adds or removes transparency from the masking area.
- **SEL POS/XPOS/YPOS** : Adjust the size and position of the selected area.
- **RETURN** : Select this to save the PRIVACY menu settings and return to the SPECIAL menu.

- **DIS (Digital Image Stabilizer)** :

This function mitigates any picture movement due to external factors such as wind.

PRIVACY AREA SETUP	
▶ 1.AREA	AREA1
2.MODE	OFF
3.MASK COLOR	GREEN
4.TRANSPARENCY	OFF
5.SEL POS	L_TOP
6.XPOS	*■■■■■ 10
7.YPOS	*■■■■■ 10
8.RETURN	↵



Note

- As the DIS function uses the digital zoom the camera's resolution will decrease.
- DIS doesn't operate when background illumination is too low.
- DIS doesn't operate when object pattern is monotonic as like sky or white wall.

● PROFILE

1) When the SETUP menu screen is displayed, select 'PROFILE' by using the Joystick so that the arrow indicates 'PROFILE'.

2) Select a desired mode using the Joystick according to the picture display you want.

■ BASIC : The most common environment is set to meet.

■ DAYNIGHT : It will be set automatically so it optimizes to the day or night conditions, respectively.

■ BACKLIGHT : It will be set automatically so you can distinguish the object from the background in a severe backlighting scene.

■ ITS : It will be set automatically so you can easily check the traffic conditions.

■ INDOOR : It will be set automatically to help you take a picture in a regular indoor lighting condition.

■ USER : Automatically configures the camera to your custom settings.

1) Select Custom for Simple Setup mode.

2) Configure the menu options to your custom settings.

3) The settings are automatically saved as Custom mode.

4) Profile user mode don't initialize when menu resets.

3) In the PROFILE menu, you can configure the following camera settings at once.

SPECIAL	
1.IMAGE ADJ	←, →
2.CAM TITLE	OFF
3.SYNC	INT
4.MOTION	OFF
5.PRIVACY	OFF
6.DIS	OFF
▶ 7.PROFILE	USER
8.COMM AD	←, →
9.RETURN	←, →

	BASIC	DAYNIGHT	BACKLIGHT	ITS	INDOOR	USER
SHUTTER	---	---	---	MANUAL(1/250)	A.FLK	-
GAIN	HIGH	HIGH	HIGH	HIGH	HIGH	-
WHITE BAL	ATW	ATW	ATW	OUTDOOR	ATW	-
BACKLIGHT	OFF	OFF	USER BLC	OFF	OFF	-
SSNR3	ON	ON	ON	ON	ON	-
DAY/NIGHT	AUTO	AUTO	AUTO	AUTO	AUTO	-

■ How to Use the Camera

- **COMMADJ (Communication Adjustment)** : Available for RS-485 type only
This function sets up the camera communication status when controlling the camera through an external control device.
 - 1) When the SPECIAL menu screen is displayed, press the Joystick so that the arrow indicates 'COMMADJ'.
 - 2) Set up the mode using the Joystick.

COMM SETUP		
▶ 1.CAM ID	*■■■■■■■	1
2.BAUD RATE		9600
3.UART MODE		8-N-1
4.RET PKT		ENABLE
5.DISP ID		OFF
6.PROTOCOL		PELCO-D
7.RETURN	←	

- **CAM ID** : Determines the camera's identification number (between 0 and 255).
- **BAUD RATE** : You can select 2400/4800/9600/19200/38400/57600 bps.
- **UART MODE** : You can select NONE, EVEN or ODD for the parity bits.
- **RET PKT** : Determines whether to send a command back to the controller device when a communication control command is sent to the camera.
- **DISP ID** : Display camera title on top left corner of the screen.
- **PROTOCOL** : Select the communication PROTOCOL.(SAMSUNG-T, SAMSUNG-E , PELCO-D, PELCO-P, BOSCH, HONEYWELL, VICON and PANASONIC)
- **RETURN** : Select this to save the PRIVACY menu settings and return to the SPECIAL menu.

* Initial value of communication adjustment

Item	Camera ID	BAUD RATE	UART MODE	PET PKT
Initial value	1	9600	8-NONE-1	ENABLE

- **RETURN** : Select this to save the SPECIAL menu settings and return to the MAIN SETUP menu.

EXIT

Select a desired EXIT mode using the Joystick depending on the camera purpose.

- **SAVE** : Save the current settings and exit the MAIN SETUP menu.
- **NOT SAVE** : Save the current settings and exit the MAIN SETUP menu. Power resets the camera settings to the previous mode except for Day/night mode.
- **RESET** : Resets the camera settings to the factory defaults. Communication, Language and Monitor settings are not initialized.

■ Troubleshooting

If you have trouble operating your camera, refer to the following table. If the guidelines do not enable you to solve the problem, contact an authorized technician.

PROBLEM	SOLUTION
Nothing appears on the screen.	<ul style="list-style-type: none">▶ Check that the power cord and line connection between the camera and monitor are fixed properly.▶ Check that you have properly connected BNC cable to the camera.
The image on the screen is dim.	<ul style="list-style-type: none">▶ Is the lens stained with dirt? Clean your lens with a soft, clean cloth.▶ Check the monitor and DVR settings.▶ If the camera is exposed to very strong light, change the camera position.
The image on the screen is dark.	<ul style="list-style-type: none">▶ Adjust the contrast feature of the monitor .▶ If you have an intermediate device, set the 75Ω / Hi-z properly.
The camera is not working properly, and the surface of the camera is hot.	<ul style="list-style-type: none">▶ Check that you have properly connected the camera to an appropriate power source.
The DAY/NIGHT menu does not work.	<ul style="list-style-type: none">▶ Check that AGC of EXPOSURE SETUP menu is 'OFF'.
The SENS-UP function does not work.	<ul style="list-style-type: none">▶ Check that AGC of EXPOSURE SETUP menu is 'OFF'.▶ Check that SHUTTER of EXPOSURE SETUP menu is 'A.FLK' or 'MANUAL'.
The INTELLIGENCE function does not work.	<ul style="list-style-type: none">▶ Check that INTELLIGENCE of menu is 'OFF'.
Color is not correct.	<ul style="list-style-type: none">▶ Check the setting of WHITE BAL SETUP menu .
The screen flickers continually.	<ul style="list-style-type: none">▶ Check that the camera is not pointing at the sun.
When coaxial communication is not available:	<ul style="list-style-type: none">▶ Make sure that the camera and monitor are installed within the recommended distance.▶ Use the video amplifier equivalent to coaxitron if the recommended installation distance is exceeded.
The camera is out of focus.	<ul style="list-style-type: none">▶ Check that you have properly adjusted the zoom/focus adjustment lever of lens.

Specifications ■

	NYSC	PAL
VIDEO		
Imaging Device	1/3" Super HAD CCD II (PAL)	
Total Pixels	1028(H) x 508(V)	1028(H) x 596(V)
Effective Pixels	976(H) x 494(V)	976(H) x 582(V)
Scanning System	2 : 1 Interlace / Progressive	
Synchronization	Internal / Line Lock	
Frequency	H:15.734KHz / V:59.94Hz	H:15.625KHz / V:50Hz
Horizontal Resolution	Color : 650 TV lines, B/W : 700 TV lines	
Min. Illumination	COLOR : 0.1 Lux (50IRE, @F1.2), 0.0002Lux (SENS-UP, x512) B/W : 0.01Lux (50IRE, @F1.2), 0.00002Lux (SENS-UP, x512)	
S / N Ratio	52dB (AGC off, Weight on)	
Video Output	CVBS : 1.0 Vp-p / 75Ω composite	
Lens Type		
Focal Length(Zoom Ratio)	2.8 ~ 11mm (Standard)	
Max. Aperture Ratio	1:1.2(Wide) ~ 2.8(Tele)	
Angular Field of View	134°(Wide) ~ 36.0°(Tele) / Diagonal	
Lens Type	DC Auto Iris	
Mount Type	Board Type	
Pan / Tilt /Rotate		
Pan/Tilt/Rotate Range	0°~359° / 0°~135° / 0°~359°	
OPERATIONAL		
On Screen Display	Multi-language Support by Coaxial Cable English, Japanese, Spanish, French, Portuguese, Korean	Multi-language Support by Coaxial Cable English, French, German, Spanish, Italian, Chinese, Russian, Polish, Czech, Romanian, Serbian, Swedish, Danish, Turkish, Portuguese, Thai
Camera Title	Off / On (Displayed 15 characters)	

■ Specifications

	NYSC	PAL
Day & Night	Auto (ICR) / EXTERNAL/ Color / B/W	
Backlight Compensation	Off/ USER BLC / HLC / SSSDR	
Dynamic Range (SSDR)	Off / On	
Digital Noise Reduction (DNR3)	Off / On	
Digital Image Stabilization	Off / On	
Privacy Masking	Off / On (12 Programmable zones, Polygonal type)	
Sens-up (Frame Integration)	2x ~ 512x	
Gain Control	Off/ Low / High	
White Balance	ATW / Outdoor / Indoor / Manual / AWC (1,700K° ~ 11,000K°)	
Electronic Shutter Speed	1/60 ~ 1/120,000 sec	1/50 ~ 1/120,000 sec
Digital Zoom	Off / On (1x ~ 16x)	
Flip / Mirror	Off / H-Rev / V-Rev / HV-Rev	
Profile	BASIC, DAYNIGHT, BACKLIGHT, ITS, INDOOR, USER	
Communication	Coaxial Control (SPC-300 Compatible)	
Environmental		
Operating Temperature / Humidity	-10°C ~ +50°C (+14°F ~ +122°F) / Less than 90% RH	
Electrical		
Input Voltage	DC 12V Only	
Power Consumption	Max. 2.5W	
Mechanical		
Dimension	Ø150 x 99mm (5.9" X 3.89")	
Weight	950g (2.09lb)	

※ This specification can be changed without notice for performance improvement of product.

Super High Resolution DNR Vandal Resistant Dome Camera

Printed in KOREA