

**High Resolution
Super DNRⅢ
Vandal Resistant
Dome Camera**

User's Manual

[DC 12V Only]

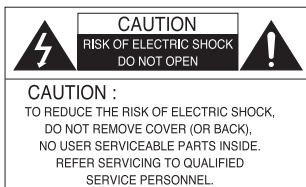



The lightning flash with an arrowhead symbol, within an equilateral triangle is intended to alert the user to the presence of uninsulated dangerous voltage within the product's enclosure that may be of sufficient magnitude to constitute a risk of electric shock to persons.



The exclamation point within an equilateral triangle is intended to alert the user to the presence of important operating and maintenance (servicing) instructions in the literature accompanying the appliance.

INFORMATION - This equipment has been tested and found to comply with limits for a Class A digital device, pursuant to part 15 of the FCC Rules. These limits are designed to provide reasonable protection against harmful interference when the equipment is operated in a commercial environment. This equipment generates, uses, and can radiate radio frequency energy and, if not installed and used in accordance with the instruction manual, may cause harmful interference to radio communications. Operation of this equipment in a residential area is likely to cause harmful interference in which case the user will be required to correct the interference at his own expense.

WARNING - Changes or modifications not expressly approved by the manufacturer could void the user's authority to operate the equipment.

CAUTION : To prevent electric shock and risk of fire hazards:

- ◆ Do NOT use power sources other than that specified.
- ◆ Do NOT expose this appliance to rain or moisture.

This installation should be made by a qualified service person and should conform to all local codes.

■ Contents

Features	04
Warning	05
Precautions	06
Components	08
Names and Functions of Parts	09
■ Lens	10
■ OSD	10
■ VBS-Extra	11
■ 3Axis Bracket	11
■ SMPS	11
■ UTP	11
Dimension	11
Installation & Cable Connection	12

How to Use the Camera

■ Set up Menu	14
■ How to Set up the Functions	15
• LENS	16
• EXPOSURE	18
• WHITE BALANCE control	20
• BACKLIGHT	21
• SSNR3 (Selected Super Noise Reduction)	23
• DAY/NIGHT	24
• SPECIAL	26
• IMAGE ADJ	27
• EXIT	30

Troubleshooting	31
-----------------------	----

Specifications	33
----------------------	----

■ Features

Ultra High Resolution

By adopting a double-speed 410,000 pixel Sony CCD, the camera produces clear picture quality with a horizontal resolution of 600 TV lines for color, and 700 TV lines for B/W.

Excellent Sensitivity

Adopting a Diagonal 6mm (1/3"), highly sensitive CCD and digital signal processing technology, it can clearly distinguish the outline and color of a subject in an extremely low luminance environment . even, for example, under starlight. Since surveillance is possible in places where the light is poor, the camera is appropriate for day and night surveillance outdoors or on the outside of buildings.

SSNR3 (Selected Super Noise Reduction) Function

The high-performance W-V DSP chip effectively removes low-light gain noise and afterimage to provide clear images even in dark environments.

Motion Detection

Since the camera detects motion and generates signals without any additional external sensors, you can monitor activity more efficiently by connecting the camera to an alarm device.

Alarm Out (option)

DIS (Digital Image Stabilizer)

The DIS function compensates for any camera movement, to produce more stable pictures.

SSDR

(Selected Super Dynamic Range)

For images with high contrast between bright and dark spots from difficult lighting conditions such as backlighting, this camera selectively illuminates darker spots while retaining the same light level for brighter spots to even out the overall brightness.

Day & Night

The camera identifies whether it is day or night and automatically switches to the appropriate mode, depending on its environment. By day, the camera switches to color mode in order to maintain optimal color. At night, it switches to B/W mode so as to obtain better picture definition.

Miscellaneous Functions

HLC(High Light Compensation), SENS-UP, FLIP (H/V-REV), D-ZOOM, SHARPNESS, MOTION DETECTION and PRIVACY functions are provided.

RS-485 Communication Control Support (option)

Remote OSD menu control via an RS-485 interface is supported.

UTP Transmitter (option)

3Axis Bracket

Weather proof

OSD

The camera control is convenient by using 8 different foreign language O.S.D.

- NTSC Korean, English, French, Spanish, Japanese, Portuguese
- PAL English, French, German, Spanish, Italian, Chinese, Russian, Czech, Polish

■ Warning

The camera needs periodic inspection.

Contact an authorized technician for inspection.

Stop using your camera when you find a malfunction.

If you use your camera around smoke or unusual heat for a long time, fire may be caused.

Do not install the camera on a surface that can not support it.

Unless the surface is suitable, it could cause falling or other hazards.

Do not hold plug with wet hands.

It could cause an electric shock.

Do not disassemble the camera.

It may result in fire, electric shock or other hazards.

Do not use the camera close to a gas or oil leak.

It may result in fire or other hazards.

■ Precautions

Do not install the camera in extreme temperature conditions.



Only use the camera under conditions where temperatures are between -10°C and $+50^{\circ}\text{C}$. Be especially careful to provide ventilation when operating under high temperatures.

Do not install or use the camera in an environment where the humidity is high.



It can cause the image quality to be poor.

Do not install the camera under unstable lighting conditions.



Severe lighting change or flicker can cause the camera to work improperly.

Do not touch the front lens of the camera.



It is one of the most important parts of the camera. Be careful not to be stained by fingerprint.

Do not drop the camera or subject it to physical shocks.



It can cause malfunctions to occur.

Never keep the camera face to strong light directly.

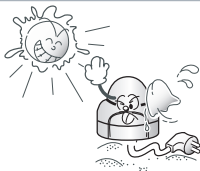

It can damage the CCD.

Do not expose the camera to radioactivity.



If it is exposed to radioactivity,
For heated CCD, it will be out of
order.



Note

- If the camera is exposed to spotlight or object reflecting strong light, smear or blooming may occur.
- Please check that the power satisfies the normal specification before connecting the camera.

■ Components

1. COLOR DOME CAMERA

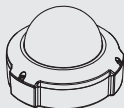

2. SCREWS

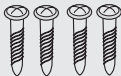

3. WRENCH

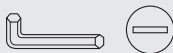

4. EXTRA DC PLUG

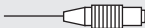

5. INSTRUCTION GUIDE



Names and Functions of Parts ■

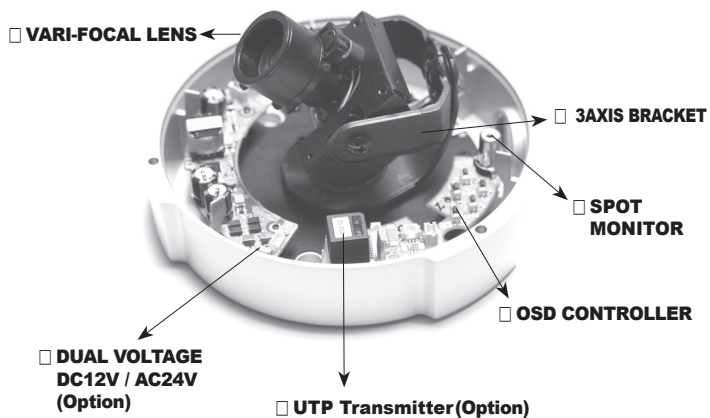

■ Names and Functions of Parts

- ① **LENS : Vari-Focal Auto Iris Lens**
(F1.2, 4.0mm ~ 9.0mm)
(F1.2, 2.8mm ~ 11mm)

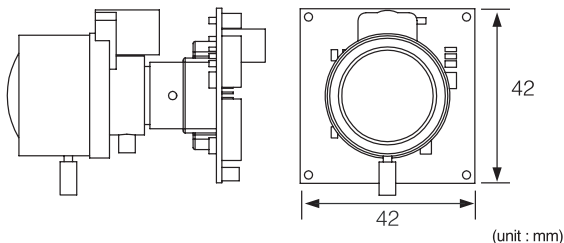

- ② **OSD PCB**

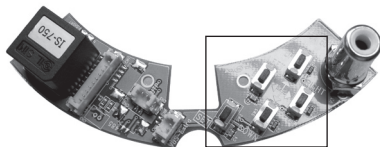

- **SETUP button** : Used for the menu display. This button can be used to confirm settings after changing the value of the selected function or current conditions.
- **UP & DOWN buttons** : Used for selecting items by moving the cursor up or down on the menu screen.
- **LEFT & RIGHT buttons** : Used when changing item values, by moving the cursor to the left or right on the menu screen.

Names and Functions of Parts ■

③ RCA Jack for a Spot Monitor

Installers can check the video output through a portable monitor at the sight .

④ 3AXIS BRACKET

Accomplish wall & Ceiling Mount

⑤ SMPS PCB FOR DUAL POWER (Option)

DC12V or AC24V Dual Input

⑥ UTP Transmitter (Option)

High quality picture transmission even in a long distance

Dimension ■

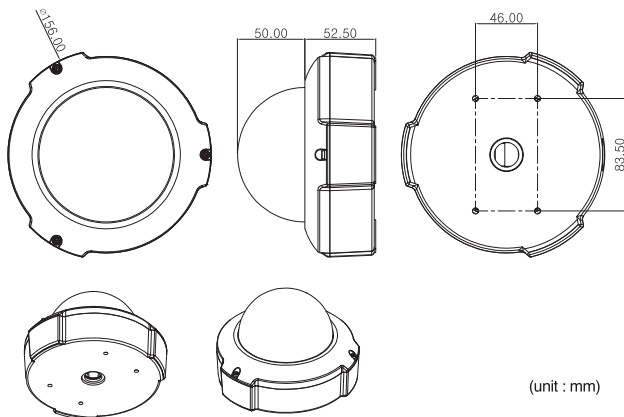

■ Installation

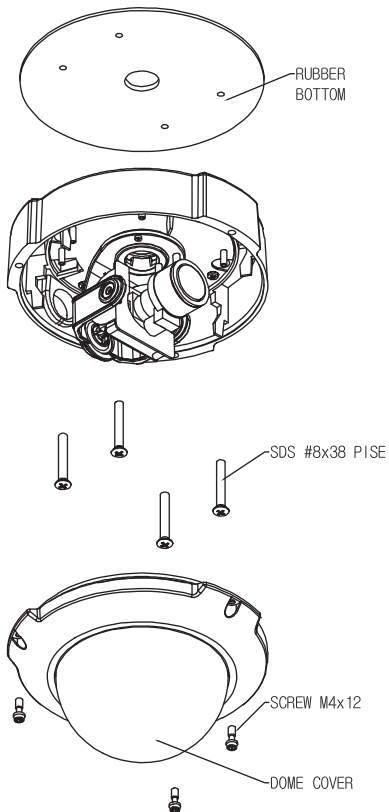

1. Dome Base Mounting

- Open the dome cover by unscrewing 3 screws using special wrench provided.
- Mount the base of camera to a sturdy surface using 4 screws (1.5 inch) and 4 premade holes on the base of the dome.

2. Power Connect & Monitor Impedance

- DC 12V/500mA regulated power supply (DC12V only)
AC24V Class 2 power supply.(AC24V/DC12V)
- To avoid fire or shock hazard, must use a UL listed power supply.
- Set the monitor impedance switch to 75Ω. Check the impedance switch when the screen turns blurred.

3. Camera Module Adjustment

- Loosen screws for 3-axis camera bracket and adjust the direction and angle of camera.
- Make sure to retighten the screws for camera bracket.
- Set any function you wish to activate by using the OSD buttons.

4. Dome Cover Mounting

- Replace the dome cover to the base and tighten 3 screws.

Cable Connection ■

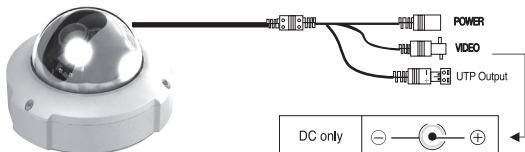

■ How to Use the Camera

Setup Menu

MAIN MENU			
LENS	● DC	● VIDEO	● MANUAL
EXPOSURE	● BRIGHTNESS	● SHUTTER	● AGC
	● SENS-UP	● RETURN	
WHITE BALANCE	● ATW	● OUTDOOR	● INDOOR
	● MANUAL	● AWC → SET	
SSDR	● OFF	● ON	
BACKLIGHT	● OFF	● BLC	● HLC
SSNR3	● OFF	● ON	
DAY/NIGHT	● COLOR	● B/W	● AUTO
	● EXTERN		
SPECIAL	● IMAGE ADJ.	● MONITOR	● CAM TITLE
	● SYNC	● MOTION DET	● PRIVACY
	● COMM ADJ	● LANGUAGE	● RETURN
EXIT	● SAVE	● NOT SAVE	● RESET

How to Set up the Functions

You can set up functions using the 5 buttons on the OSD Board

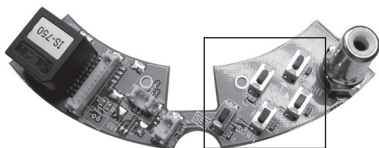

1. Press the SET button.

Main setup menu is displayed on the monitor screen.

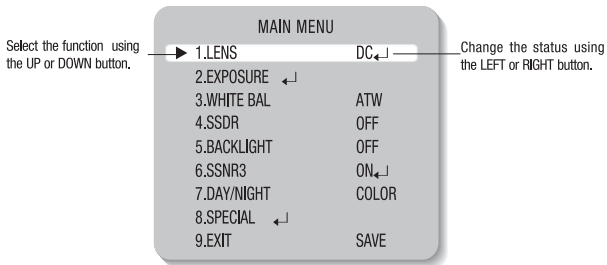

2. Select a desired function using the Up and Down buttons.
Place the cursor over a desired item.

■ How to Use the Camera

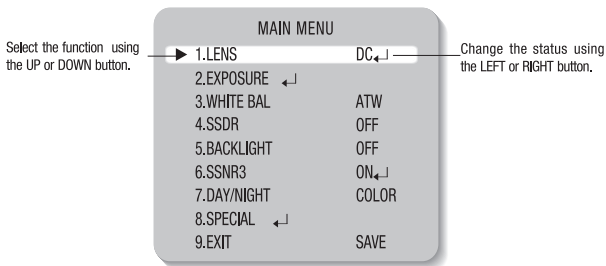

3. Set up a selected item by using the Left and Right buttons.
4. To finish the setting, select 'EXIT' and press the SET button.



Note

- An item with the ◀ icon also has sub menus. To select a sub menu, select an item with the icon and press the SET button.
- An item with the - - - icon is unavailable due to function settings.

LENS

Using this function, you can control screen brightness.

1. When the SETUP menu screen is displayed, select LENS by using the Up and Down buttons so that the arrow indicates LENS .
2. Select the connected lens type by using the Left and Right buttons.



⇒ DC/Video : Select Auto Iris Lens

You can adjust the minimum shutter and maximum value of ESC shutter mode when DC Lens mode is selected.

⇒ Manual : Select Manual Lens

3. Each Lens mode has sub menu items as listed below.

Brightness-(DC, Manual) Adjusts the video brightness.

Level (VIDEO) Adjusts the level of video iris signals; the higher the level is, the brighter the video looks.

FOCUS ADJ. (DC, VIDEO) To adjust the DC and VIDEO lens focus correctly, you must activate the Focus Settings mode under each lens menu. Activate the Focus Settings mode, adjust the lens focus, and then deactivate the settings mode. (The VIDEO lens requires an extra step: go to the sub menu of the Focus Settings mode and change the shutter speed to adjust the lens brightness.)

- IRIS SPEED (DC) : Adjusts the Iris control speed of the DC lens. If the control speed is too slow or fast, please use this menu to adjust the speed.



Notes

- When using VIDEO lens, adjust the lens VR explained below first and set the focus using 'FOCUS ADJ.' menu.
- If color rolling occurs when using a DC lens, set Shutter to A.FLK.
- Some lenses may not work properly, depending on the setting of the BRIGHTNESS LEVEL.
- When Using a Video-Type Auto Iris Lens
 - ① Adjust the ALC adjustment terminal on the lens appropriately. In general, set it to AV (Average).
 - ② It may not work properly depending on the installed lens. Set the Level VR of the lens to the optimal value.
 - ③ Set AGC to OFF and adjust the Lens VR to an appropriate brightness.
 - ④ Adjust the Lens VR, adjust the BRIGHTNESS, and then check if the screen brightness changes properly. Otherwise, adjust the Lens VR again.

■ How to Use the Camera

EXPOSURE

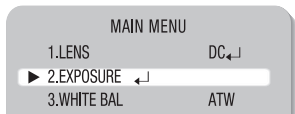

1. When the SETUP menu screen is displayed, select ' EXPOSURE ' by using the Up and Down buttons so that the arrow indicates ' EXPOSURE ' .
2. Select a desired mode using the Up and Down buttons.

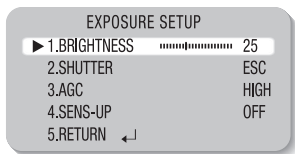

- SHUTTER : You can select either auto or manual shutter.
 - A.FLK : Select this when you experience picture flicker, which can happen when there is a clash with the frequency of the installed lighting.
 - ESC : Select this to control the shutter speed automatically. If ESC is selected, the shutter speed is automatically controlled depending on the ambient illumination of the subject.
 - MANUAL : You can control shutter speed manually. (1/60 ~ 1/120,000)



Notes

- When you use a DC lens, set the shutter mode to A.FLK if color rolling occurs.
- When the SHUTTER is set to ESC after selecting the Internal Synchronization Type, the picture may become unstable if the camera faces a bright fluorescent light. Therefore, take care when choosing the installation position.
- When the SHUTTER is set to MANUAL or A.FLK mode, SENS-UP will be disabled.

- AGC(AUTO GAIN CONTROL) : The higher the gain level, the brighter the screen - but the higher the noise.
 - OFF : Deactivates the AGC function.
 - LOW : Allows automatic gain control from 5.3dB to 32dB.
 - HIGH : Allows automatic gain control from 5.3dB to 37dB.
- SENS-UP : When it is night or dark, the camera automatically detects the light level and maintains a clear picture if this mode is activated.
 - OFF : Deactivates the SENS-UP function.
 - AUTO : Activates the SENS-UP function.
- RETURN : Select this to save the changes in the EXPOSURE menu and return to the SETUP menu.



Notes

- If you press the SET button in 'AUTO' mode, You can adjust brightness by increasing or decreasing the shutter speed. (x2 ~ x512)
- Note that the higher the zoom level, the brighter the screen, but the more likely it is that an after-image will appear.
- Although Noise, Spots, and Whitish symptoms may occur in SENS-UP operation when the zoom level is increased, this is normal.

■ How to Use the Camera

White Balance (White Bal.)

Use the White Balance function to adjust the screen color.

1. When the SETUP menu screen is displayed, select 'White Bal.' by using the Up and Down buttons so that the arrow indicates 'White Bal.'
2. Select a desired mode using the Up and Down buttons.

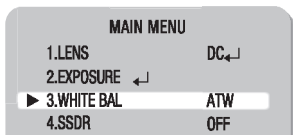

- ※ Select one of the following 5 modes, as appropriate for your purpose.
- ATW Select this when the color temperature is between 1,700°CK and 11,000°CK.
 - OUTDOOR Select this when the color temperature is between 1,700°CK and 11,000°CK (sodium light inclusion)
 - INDOOR : Select this when the color temperature is between 4,500°CK and 8,500°CK.
 - MANUAL Select this to fine-tune White Balance manually. Set White Balance first by using the ATW or AWC mode. After that switch to MANUAL mode, fine-tune the White Balance and then press the SET button.
 - AWC → SET : To find the optimal luminance level for the current environment, point the camera towards a sheet of white paper and press the Function Setup switch. If the environment changes, readjust it.



Notes

- White Balance may not work properly under the following conditions. In this case select the AWC mode.
 - ① When the color temperature of the environment surrounding the subject is out of the control range (e.g. clear sky or sunset).
 - ② When the ambient illumination of the subject is dim.
 - ③ If the camera is directed towards a fluorescent light or is installed in a place where illumination changes dramatically, the White Balance operation may become unstable.

SSDR (Selected Super Dynamic Range)

SSDR illuminates darker spots of an image while retaining the same light level for brighter spots to even out the overall brightness of images with high contrast between bright and dark spots.

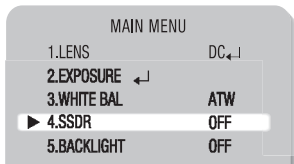

1. When the SETUP menu screen is displayed, select 'SSDR' by using the Up and Down buttons so that the arrow indicates 'SSDR'.
2. Use the Left/Right buttons to change the SSDR level in the sub menu according to the contrast between bright and dark spots.

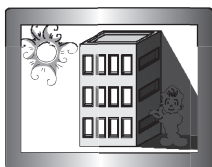
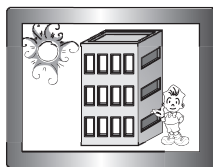

BACKLIGHT

This camera is designed so that it delivers a distinctive subject and background at the same time, even when the subject is in backlight, unlike conventional cameras, by adopting a proprietary W-V DSP chip.

1. When the SETUP menu screen is displayed, select 'BACKLIGHT' by using the Up and Down buttons so that the arrow indicates 'BACKLIGHT'.

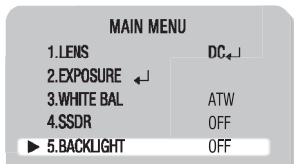

■ How to Use the Camera

2. Select a desired mode using the Left and Right buttons depending on the camera purpose.

- BLC : Enables a user to directly select a desired area from a picture, and to view the area more clearly.



BLC ON



BLC OFF

- HLC (High Light Compensation) :

If the scene contains extremely brightly light areas such as; from car headlight, the light can mask out much of the on-screen detail. Use Samsung Techwin's HLC feature to remove these exceptionally brightly light areas to allow detail such as car number plates to become visible.

- LEVEL : Adjust level of the HLC function.
- LIMIT : Enable to change the operating condition.
- MASK COLOR/TONE : Change the color / brightness of the masking area.
(Black, Red, Blue, Cyan, Magenta)
- TOP/BOTTOM/LEFT/RIGHT : Adjust the area to be enhanced.

HLC MASKING AREA

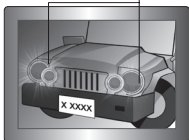

HLC ON



HLC OFF

- OFF : Not being used

3. Select a desired mode using the Left and Right buttons and press the SET button.

- Select 'BLC' to adjust the area to be enhanced then adjust the level.
- HLC : Enable the user to change the level, limit, mask color/tone and area.

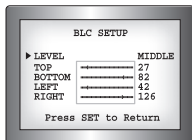

Notes

- For effective license plate observation, it needs minimum illumination and fast shutter speed more than 1/200sec.
- Because there can be a difference in the effectiveness of HLC according to the amount of light area in the screen, optimize the installation angle for the best HLC performance.
- When dark, the HLC is only activated when a bright light exceeding a specific size.in NIGHT ONLY mode.
- The HLC is not activated in day light or when bright light is not present at night.in NIGHT ONLY mode.

SSNR3

This function reduces the background noise in a low luminance environment.

1. When the SETUP menu screen is displayed, select 'SSNR' by using the Up and Down buttons so that the arrow indicates 'SSNR' .

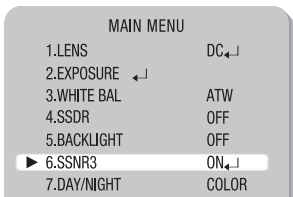

2. Select a desired mode using the Left and Right buttons.
 - OFF : Deactivates SSNR. Noise is not reduced.
 - ON Activates :SSNR so that noise is reduced.
3. Set the SSNR mode to 'ON' and press the SET button. Then you can adjust the noise reduction level.

Notes

- You cannot set the SSNR to 'ON' or 'OFF' when the AGC mode of the EXPOSURE menu is 'OFF'.
- When adjusting the noise reduction level in the SSNR mode, remember that the higher the level set, the more the noise level will be reduced, as will the brightness of the image.

■ How to Use the Camera

DAY/NIGHT

You can display pictures in color or black and white.

1. When the SETUP menu screen is displayed, select 'DAY/NIGHT' by using the Up and Down buttons so that the arrow indicates 'DAY/NIGHT'.

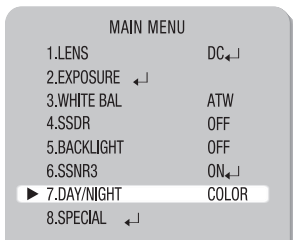

2. Select a desired mode using the Left and Right buttons according to the picture display you want.

- COLOR : The picture is always displayed in color.
- B/W : The picture is always displayed in black and white.
You can turn on or off the burst signal on B/W mode.
- AUTO The mode is switched to 'Color' in a normal environment, but switches to 'B/W' mode when ambient illumination is low. To set up the switching time for AUTO mode, press the SET button.
You can turn on or off the burst signal on B/W mode.

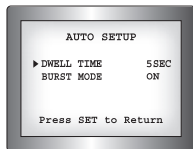

- DWELL TIME :You can select the duration time about changing the day/night mode.
→ 5s, 7s, 10s, 15s, 20s, 30s, 40, 60s
- If strong infrared illuminator used with our camera at "AUTO" mode, it possible to repeat Color & B/W image during nighttime by infrared illuminators.

- **EXTERN:** This mode allows you to apply a desired filter to external signals. This mode available only incase of filter change lens installed.



Note

- When using a Video Auto Iris Lens, if you set the lens level to low, automatic switching between Color and Black & White may not occur.
- You cannot control the DAY/NIGHT menu when AGC in the EXPOSURE menu is 'OFF'.
At this time, the exchange between DAY mode and NIGHT mode operates as like selecting 'COLOR' mode.
- The OSD key does not work for 3 seconds when switching to Color or B/W, to ensure stable camera operation.
- The camera may focus less well under infrared illumination than under normal illumination.
- Since the camera may not focus as well under infrared illumination at night as it does under normal illumination, install an Extra-low Dispersion Lens to obtain sharp pictures.

■ How to Use the Camera

SPECIAL

1. When the SETUP menu screen is displayed, select 'SPECIAL' by using the Up and Down buttons so that the arrow indicates 'SPECIAL'.

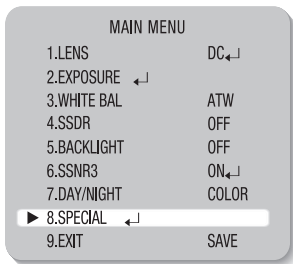

2. Select a desired mode using the Up and Down buttons.

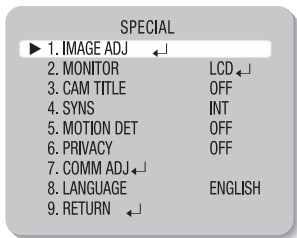

◀ IMAGE ADJ. :

When the SETUP menu screen is displayed, select 'IMAGE ADJ.' by using the Up and Down buttons so that the arrow indicates 'IMAGE ADJ.'.

2) Select a desired mode using the Up and Down buttons.

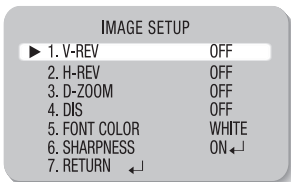

- V-REV : You can flip the picture vertically on the screen.
- H-REV : You can flip the picture horizontally on the screen.
- D-ZOOM : You can use a digital zoom of x1 ~ x16.
- DIS(Digital Image Stabilizer) :
This function mitigates any picture movement due to external factors such as wind.
- FONT COLOR : You can change the OSD font color. (White, Yellow, Green, Red, Blue)
- SHARPNESS : As you increase this value, the picture outline becomes stronger and clearer. Adjust this value appropriately depending on the sharpness of the picture.
- RETURN : Select this to save the settings for the IMAGE ADJ. menu and to return to the SETUP menu.



Notes

- When the V-REV or H-REV mode is enabled, the text on the screen does not flip.
- If you increase the SHARPNESS level too high, the picture may become distorted or noise may appear.

◀ Monitor : Please change the settings value of video appropriate to your monitor.

- LCD : Please select this menu item when using an LCD monitor.
- CRT : Please select this menu item when using a CRT monitor.
- USER : Please use this menu item when using a monitor other than standard ones. You can change the gamma, PED level, and color gain in the sub menus.

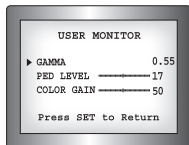

■ How to Use the Camera

☉ CAM TITLE : If you enter a title, the title will appear on the monitor.

If the SPECIAL menu screen is displayed, use the Up and Down buttons so that the arrow indicates 'CAM TITLE'.

- 2) Set it to 'ON' by using the Left and Right buttons.
- 3) Press the SET button.
- 4) Use the 4 direction buttons to move to a desired letter and select the letter by pressing the SET button. Repeat this to enter multiple letters. You can enter up to 15 letters.
- 5) Enter a title, move the cursor to 'POS' and press the SET button. The entered title appears on the screen. Select the position to display the title on the screen by using the 4 direction buttons and press the SET button. When the position is determined, select 'END' and press the SET button to return to the SPECIAL menu.

```
CAMERA TITLE SETUP
A B C D E F G H I J K L M
N O P Q R S T U V W X Y Z
a b c d e f g h i j k l m
n o p q r s t u v w x y z
- . 0 1 2 3 4 5 6 7 8 9
← → CLR POS END
```



Notes

- When the CAM TITLE menu is 'OFF', no title will be displayed on the monitor screen even if you enter one.
- Only English is available in this mode.
- If you move the cursor to CLR and press the SET button, all the letters are deleted. To edit a letter, change the cursor to the bottom left arrow and press the SET button. Move the cursor over the letter to be edited, move the cursor to the letter to be inserted and then press the SET button.

☉ SYNC : In areas where the supply is at 60Hz, you can synchronize the output phase of multiple cameras using the power synchronization function (Line-Lock) without using a synchronization signal generator.

- INT : Internal Synchronization Type
 - L/L : Power Synchronization Type, Line-lock
- Press the Function Setup switch.

You can select a desired phase from 0 to 359 when select 'phase'.

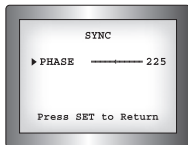



Notes

- When using AC power at 60Hz frequency, you can use the L/L type synchronization.
- When the power is DC 12V, the SYNC menu is fixed to the 'INT' mode.

MOTION DET :

This product has a feature that allows you to observe movement of objects in 8 different areas on the screen, and the words 'MOTION DETECTED' appear on the screen when movement is detected. you can monitor activity more efficient.

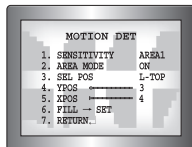

1) When the SPECIAL menu screen is displayed, press the Up and Down buttons so that the arrow indicates ' MOTION DET ' .

2) Set up the mode using the 4 direction buttons.

- SENSITIVITY : You can select up to 8 MD areas. When SENSITIVITY number is high, motion detection sensitivity is increased to recognize even small movement.
- AREA MODE : Determines whether to use the MD area selected in SENSITIVITY.
- SEL POS : Determines which of the 4 vertices of each MD area is to be used.
- YPOS : Determines the coordinate of the vertical axis for SEL POS.
- XPOS : Determines the coordinate of the horizontal axis for SEL POS.
- FILL? SET : Fills in a selected MD area. Fills in a selected MD area. The color of filling is sequentially selected as brown, orange, blue, cyan, yellowish green, yellow and red.
- RETURN : Select this to save the MOTION DET menu settings and return to the SPECIAL menu.

PRIVACY : Mask an area you want to hide on the screen.

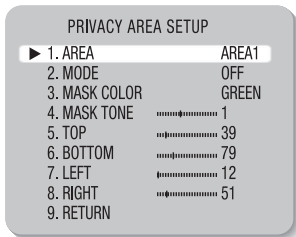

■ How to Use the Camera

- 1) When the SPECIAL menu screen is displayed, press the Up and Down buttons so that the arrow indicates 'PRIVACY'.
- 2) Set up the mode using the 4 direction buttons.
 - AREA SEL : You can select up to 12 PRIVACY areas.
 - MODE : Determines whether to use the area selected in the AREA SEL.
 - MASK COLOR : Determine area color. You can select Green, Red, Blue, Black, White, Gray.
 - MASK TONE : Adjust the brightness of MASK COLOR.
 - TOP/BOTTOM/LEFT/RIGHT : Adjust the size and position of the selected area.
 - RETURN : Select this to save the PRIVACY menu settings and return to the SPECIAL menu.

- COMM ADJ (Communication Adjustment) : This function sets up the camera communication status when controlling the camera through an external control device.

- ① When the SPECIAL menu screen is displayed, press the Up and Down buttons so that the arrow indicates 'COMM ADJ'.

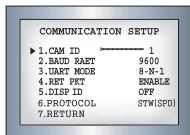

- ② Set up the mode using the 4 direction buttons.

- CAM ID : Determines the camera's identification number (between 0 and 255).
- BAUD RATE : You can select 2400/4800/9600/19200/38400/57600 bps.
- UART MODE : You can select NONE, EVEN or ODD for the parity bits.
- RET PKT : Determines whether to send a command back to the controller device when a communication control command is sent to the camera.
- DISP CAM ID : Display camera title on top left corner of the screen.
- PROTOCOL : Select same protocol along with your controller (STW(SPD), Pelco-D, Pelco-P, SEC, Bosch, Honeywell, vicon, pana)

- ③ RS-485 function is option.

- LANGUAGE : You can select the menu language according to your requirements.
- RETURN : Select this to save the SPECIAL menu settings and return to the MAIN SETUP menu.

EXIT

Select a desired EXIT mode using the Left and Right buttons depending on the camera purpose.

- SAVE : Save the current settings and exit the MAIN SETUP menu.
- NOT SAVE : Do not save the current settings and exit the MAIN SETUP menu.
- RESET : Resets the camera settings to the factory defaults. Language and Monitor settings are not initialized.

If you have trouble operating your camera, refer to the following table. If the guidelines do not enable you to solve the problem, contact an authorized technician.

Problem	Solution
Nothing appears on the screen.	<ul style="list-style-type: none"> • Check that the power cord and line connection between the camera and monitor are fixed properly.
The image on the screen is dim.	<ul style="list-style-type: none"> • Is lens stained with dirt? Clean your lens with soft, clean cloth. • Set the monitor to proper condition. • If the camera is exposed to too strong light, change the camera position.
The image on the screen is dark.	<ul style="list-style-type: none"> • Adjust the contrast feature of the monitor. • If you have an intermediate device, set the 75.0/Hi-z properly.
The camera is not working properly, and the surface of the camera is hot.	<ul style="list-style-type: none"> • Check that you have properly connected the camera to an appropriate power source.
The DAY/NIGHT menu does not work.	<ul style="list-style-type: none"> • Check that AGC of EXPOSURE SETUP menu is 'OFF'.
The SENS-UP function does not work.	<ul style="list-style-type: none"> • Check that AGC of EXPOSURE SETUP menu is 'OFF'. • Check that SHUTTER of EXPOSURE SETUP menu is 'A.FLK' or 'MANUAL'.

■ Troubleshooting

Problem	Solution																
The Motion Detection function does not work.	<ul style="list-style-type: none"> Check that MOTION DEF of SPECIAL SETUP menu is 'OFF'. 																
Color is not correct.	<ul style="list-style-type: none"> Check the setting of WHITE BAL SETUP menu . 																
The screen flickers continually.	<ul style="list-style-type: none"> Check that direction of camera turns toward the Sun. 																
RS-485 communication fails.	<ul style="list-style-type: none"> Check the polarity between RS-485 Control Port and RS-485 cable. <table border="1" data-bbox="436 682 911 755"> <thead> <tr> <th>485 Control Board Connection Port</th> <th>RS-485 Control Port</th> </tr> </thead> <tbody> <tr> <td>(+) CONNECTION TERMINAL (TRX+)</td> <td>485+</td> </tr> <tr> <td>(-) CONNECTION TERMINAL (TRX-)</td> <td>485-</td> </tr> </tbody> </table> Check the RS-485 Communication establishment initial value * RS-485 Communication establishment initial value <table border="1" data-bbox="436 885 911 936"> <thead> <tr> <th>Item</th> <th>Camera ID</th> <th>BAUD RATE</th> <th>UART MODE</th> <th>PET PKT</th> </tr> </thead> <tbody> <tr> <td>Initial value</td> <td>1</td> <td>9600</td> <td>8-NONE-1</td> <td>ENABLE</td> </tr> </tbody> </table> 	485 Control Board Connection Port	RS-485 Control Port	(+) CONNECTION TERMINAL (TRX+)	485+	(-) CONNECTION TERMINAL (TRX-)	485-	Item	Camera ID	BAUD RATE	UART MODE	PET PKT	Initial value	1	9600	8-NONE-1	ENABLE
485 Control Board Connection Port	RS-485 Control Port																
(+) CONNECTION TERMINAL (TRX+)	485+																
(-) CONNECTION TERMINAL (TRX-)	485-																
Item	Camera ID	BAUD RATE	UART MODE	PET PKT													
Initial value	1	9600	8-NONE-1	ENABLE													

Specifications ■

		NTSC	PAL
POWER	Input Voltage	DC12V	
	Power Consumption	4.0W	
CCD	Size	Diagonal 6mm (1/3") Sony Highly Sensitive CCD	
	Total Pixels	811(H) x 508(V)	795(H) x 596(V)
	Effective Pixels	768(H) x 494(V)	752(H) x 582(V)
Sync	Scanning System	2:1 Interlace	
	Synchronization	Internal / Line Lock	
	Frequency	Horizontal : 15.734 KHz, Vertical:59.94 Hz	Horizontal : 15.625 KHz, Vertical:50.00 Hz
E L E C T R I C A L	Horizontal Resolution	600TVL	
	Min. Illumination	0.05 Lux(50IRE, No SENS-UP) / 0.0001Lux (SENS-UP x512) @F1.2	
	S/N (Y Signal)	52dB (Weight Off, AGC Off)	
	Video Output	CVBS : 1.0Vp-p, 75Ω composite	
	IRIS Adjustment	DC / VIDEO	
	Electronic Shutter Speed	1/60 ~ 1/120K sec	1/50 ~ 1/120K sec
	On Screen Display	NTSC : Korean, English, Japanese, Spanish, French, Portuguese PAL : English, French, German, Spanish, Italian, Chinese, Russian, Polish, Czech	
	SSDR	On / Off (Level adjustable)	
	Backlight Compensation	BLC / HLC / OFF	
	Day & Night	COLOR / BW / AUTO (Electric)	
	Gain Control	Low / High / Off	
	White Balance	ATW / OUTDOOR / INDOOR / MANUAL / AWC (1,700°K ~ 11,000°K)	
	SENS-UP (frame Integration)	Auto /Off (Selectable x2 ~ x512)	
	Motion Detection	On / Off (8 Programmable zones)	
	Privacy Masking	On / Off (12 Programmable zones)	
	3D Noise Filter (SSNR Filter)	On / Off (Level adjustable)	
	Digital Zoom	On / Off (x1 ~ x16)	
	Digital Image Stabilization(DIS)	On / Off	
	Camera Title	Off / On (Displayed 15 Characters)	
	Sharpness	On / Off (Level adjustable)	
	Flip / Mirror	On / Off	
	Operating Temp/Humid	-10°C ~ +50°C / 30% ~ 80% RH	
Storage Temp/Humid	-20°C ~ +60°C / 20% ~ 90% RH		

High Resolution Super DNRⅢ Vandal Resistant Dome Camera

Printed in KOREA