

DS-2CE72KF0T-LFS 3K ColorVu Audio Fixed Turret Camera



- High quality imaging with 3K, 2960 × 1665 resolution
- 24/7 color imaging with F1.0 aperture
- 2.8 mm and 3.6 mm fixed focal lens
- Up to 40 m IR distance for bright night imaging
- Up to 40 m white light distance for bright night imaging
- High quality audio with audio over coaxial cable, built-in mic
- One port for four switchable signals (TVI/AHD/CVI/CVBS)
- Water and dust resistant (IP67)

▪ Specification

Camera	
Image Sensor	3K CMOS
Signal System	PAL/NTSC
Resolution	2960 (H) × 1665 (V)
Frame Rate	TVI: 3K @20 fps, 4 MP @25 fps/30 fps, 1080p @25 fps/30 fps AHD: 5 MP @20 fps, 4 MP @25 fps/30 fps CVI: 4 MP @25 fps/30 fps CVBS: PAL/NTSC
Min. Illumination	0.001 Lux @(F1.0, AGC ON), 0 Lux with white light
Shutter Time	PAL: 1/25 s to 1/50,000 s;NTSC: 1/30 s to 1/50,000 s
Lens	2.8 mm, 3.6 mm fixed focal lens
Field of View	2.8 mm, horizontal FOV: 110°, vertical FOV: 60°, diagonal FOV: 143° 3.6 mm, horizontal FOV: 94°, vertical FOV: 50°, diagonal FOV: 112°
Lens Mount	M12
Light Alarm	Solid Light Alarm (White Light)
Day & Night	ICR
WDR (Wide Dynamic Range)	Digital WDR
Angle Adjustment	Pan: 0° to 360°, Tilt: 0° to 75°, Rotation: 0° to 360°
Illuminator	
Supplement Light Type	IR, White Light
Supplement Light Range	IR: Up to 40 m,White Light: Up to 40 m
Smart Supplement Light	Yes
Image	
White Light	Auto/Off
Image Mode	STD/HIGH-SAT/HIGHLIGHT
AGC	Yes
Day/Night Mode	Auto
White Balance	Auto/Outdoor/Global/Manual
AE (Auto Exposure) Mode	DWDR,BLC,HLC,Global,HLS
Noise Reduction	2D DNR
Language	English
Function	Brightness,Smart IR,Sharpness,Anti-Banding,AGC
Interface	
Video Output	Switchable TVI/AHD/CVI/CVBS
Audio In	Built-in mic
General	
Power	12 VDC ± 25%, max.5.2 W,*You are recommended to use one power adapter to supply the power for one camera.
Operating Conditions	-40 °C to 60 °C (-40 °F to 140 °F), Humidity: 90% or less (non-condensing)
Protection Level	IP67
Material	Enclosure: Plastic Main body: Metal
Communication	HIKVISION-C

Dimension	Ø109.98 mm × 98.27 mm (Ø4.33" × 3.87")
Weight	Approx. 320 g (0.71 lb.)

▪ **Available Model**

DS-2CE72KF0T-LFS(2.8mm)





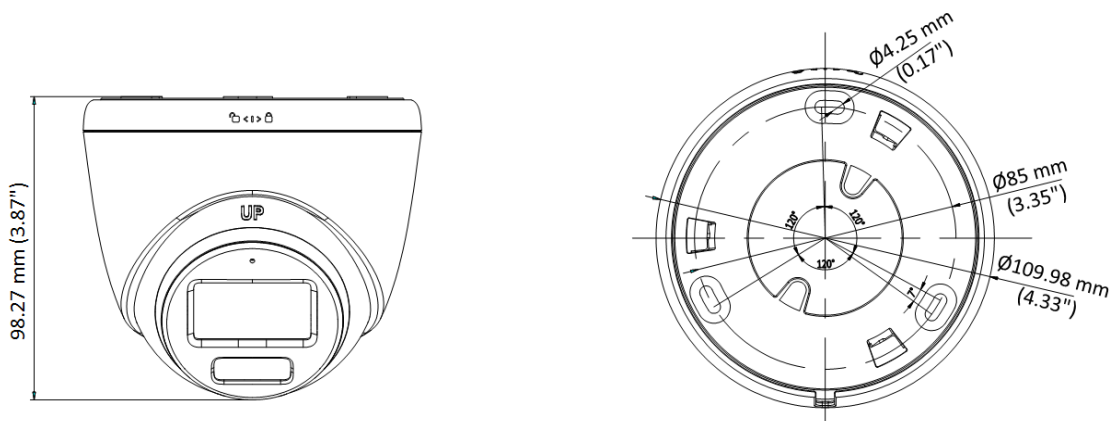



DS-2CE72KF0T-LFS(3.6mm)

▪ **Dimension**

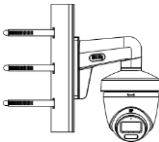
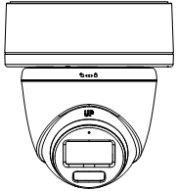

▪ **Accessory**

▪ **Optional**

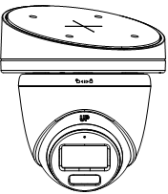
DS-2280ZJ Wall Mount	DS-1276ZJ-SUS Corner Mount	DS-1275ZJ-SUS Vertical Pole Mount	DS-1280ZJ-S Junction Box	DS-1272ZJ-110-TRS Wall Mount
				
				
DS-1281ZJ-S Inclined Ceiling Mount				
				
				

Headquarters

No.555 Qianmo Road, Binjiang District,
Hangzhou 310051, China
T +86-571-8807-5998
www.hikvision.com



Follow us on social media to get the latest product and solution information.

