



**Thermal Network Bullet Camera
Quick Start Guide**

© 2019 Hangzhou Hikvision Digital Technology Co., Ltd. All rights reserved.

About this Manual

The Manual includes instructions for using and managing the Product. Pictures, charts, images and all other information hereinafter are for description and explanation only. The information contained in the Manual is subject to change, without notice, due to firmware updates or other reasons. Please find the latest version of this Manual at the Hikvision website (<http://www.hikvision.com/>).

Please use this Manual with the guidance and assistance of professionals trained in supporting the Product.

Trademarks Acknowledgement

HIKVISION and other Hikvision's trademarks and logos are the properties of Hikvision in various jurisdictions.

Other trademarks and logos mentioned are the properties of their respective owners.

LEGAL DISCLAIMER

TO THE MAXIMUM EXTENT PERMITTED BY APPLICABLE LAW, THIS MANUAL AND THE PRODUCT DESCRIBED, WITH ITS HARDWARE, SOFTWARE AND FIRMWARE, ARE PROVIDED "AS IS" AND "WITH ALL FAULTS AND ERRORS". HIKVISION MAKES NO WARRANTIES, EXPRESS OR IMPLIED, INCLUDING WITHOUT LIMITATION, MERCHANTABILITY, SATISFACTORY QUALITY, OR FITNESS FOR A PARTICULAR PURPOSE. THE USE OF THE PRODUCT BY YOU IS AT YOUR OWN RISK. IN NO EVENT WILL HIKVISION BE LIABLE TO YOU FOR ANY SPECIAL, CONSEQUENTIAL, INCIDENTAL, OR INDIRECT

DAMAGES, INCLUDING, AMONG OTHERS, DAMAGES FOR LOSS OF BUSINESS PROFITS, BUSINESS INTERRUPTION, OR LOSS OF DATA, CORRUPTION OF SYSTEMS, OR LOSS OF DOCUMENTATION, WHETHER BASED ON BREACH OF CONTRACT, TORT (INCLUDING NEGLIGENCE), PRODUCT LIABILITY, OR OTHERWISE, IN CONNECTION WITH THE USE OF THE PRODUCT, EVEN IF HIKVISION HAS BEEN ADVISED OF THE POSSIBILITY OF SUCH DAMAGES OR LOSS.

YOU ACKNOWLEDGE THAT THE NATURE OF INTERNET PROVIDES FOR INHERENT SECURITY RISKS, AND HIKVISION SHALL NOT TAKE ANY RESPONSIBILITIES FOR ABNORMAL OPERATION, PRIVACY LEAKAGE OR OTHER DAMAGES RESULTING FROM CYBER-ATTACK, HACKER ATTACK, VIRUS INSPECTION, OR OTHER INTERNET SECURITY RISKS; HOWEVER, HIKVISION WILL PROVIDE TIMELY TECHNICAL SUPPORT IF REQUIRED.

YOU AGREE TO USE THIS PRODUCT IN COMPLIANCE WITH ALL APPLICABLE LAWS, AND YOU ARE SOLELY RESPONSIBLE FOR ENSURING THAT YOUR USE CONFORMS TO THE APPLICABLE LAW. ESPECIALLY, YOU ARE RESPONSIBLE, FOR USING THIS PRODUCT IN A MANNER THAT DOES NOT INFRINGE ON THE RIGHTS OF THIRD PARTIES, INCLUDING WITHOUT LIMITATION, RIGHTS OF PUBLICITY, INTELLECTUAL PROPERTY RIGHTS, OR DATA PROTECTION AND OTHER PRIVACY RIGHTS. YOU SHALL NOT USE THIS PRODUCT FOR ANY PROHIBITED END-USES, INCLUDING THE DEVELOPMENT OR PRODUCTION OF WEAPONS OF MASS DESTRUCTION, THE DEVELOPMENT OR PRODUCTION OF CHEMICAL OR BIOLOGICAL WEAPONS, ANY ACTIVITIES IN THE CONTEXT RELATED TO ANY NUCLEAR EXPLOSIVE OR UNSAFE NUCLEAR FUEL-CYCLE, OR IN SUPPORT OF HUMAN RIGHTS ABUSES.

IN THE EVENT OF ANY CONFLICTS BETWEEN THIS MANUAL AND THE APPLICABLE LAW, THE LATER PREVAILS.

Regulatory Information

FCC Information

Please take attention that changes or modification not expressly approved by the party responsible for compliance could void the user's authority to operate the equipment.

FCC compliance: This equipment has been tested and found to comply with the limits for Class A device, pursuant to part 15 of the FCC Rules. These limits are designed to provide reasonable protection against harmful interference when the equipment is operated in a commercial environment. This equipment generates, uses, and can radiate radio frequency energy and, if not installed and used in accordance with the instruction manual, may cause harmful interference to radio communications. Operation of this equipment in a residential area is likely to cause harmful interference in which case the user will be required to correct the interference at his own expense.

FCC Conditions

This device complies with part 15 of the FCC Rules. Operation is subject to the following two conditions:

1. This device may not cause harmful interference.
2. This device must accept any interference received, including interference that may cause undesired operation.

EU Conformity Statement



This product and - if applicable - the supplied accessories too are marked with "CE" and comply therefore with the applicable harmonized European standards listed under the EMC Directive 2014/30/EU, the RoHS Directive 2011/65/EU.



2012/19/EU (WEEE directive): Products marked with this symbol cannot be disposed of as unsorted municipal waste in the European Union. For proper recycling, return this product to your local supplier upon the purchase of equivalent new equipment, or dispose of it at designated collection points. For more information see: www.recyclethis.info





2006/66/EC (battery directive): This product contains a battery that cannot be disposed of as unsorted municipal waste in the European Union. See the product documentation for specific battery information. The battery is marked with this symbol, which may include lettering to indicate cadmium (Cd), lead (Pb), or mercury (Hg). For proper recycling, return the battery to your supplier or to a designated collection point. For more information see: www.recyclethis.info

Industry Canada ICES-003 Compliance

This device meets the CAN ICES-3 (A)/NMB-3(A) standards requirements.

Symbol Convention

The symbols that may be found in this document are defined as follows.

Symbol	Description
 NOTE	Provides additional information to emphasize or supplement important points of the main text.
 WARNING	Indicates a potentially hazardous situation, which if not avoided, could result in equipment damage, data loss, performance degradation, or unexpected results.
 DANGER	Indicates a hazard with a high level of risk, which if not avoided, will result in death or serious injury.

Safety Instruction

These instructions are intended to ensure that user can use the product correctly to avoid danger or property loss.

Laws and Regulations

- The lightning protection and grounding design of outdoor installation and wiring should be in compliance with the lightning protection requirements of the buildings and local laws and regulations.
- Use of the product must be in strict compliance with the local electrical safety regulations.

Storage

- Store the device in dry, well-ventilated, corrosive-gas-free, no direct sunlight, and no heating source environment. Neglect may cause fire hazard.

- To avoid heat accumulation, good ventilation is required for a proper operating environment.
- DO NOT touch the heat dissipation component to avoid burns.

Transportation

- Keep the device in original or similar packaging while transporting it.
- Keep all wrappers after unpacking them for future use. In case of any failure occurred, you need to return the device to the factory with the original wrapper. Transportation without the original wrapper may result in damage on the device and the company shall not take any responsibilities.
- DO NOT drop the product or subject it to physical shock. Keep the device away from magnetic interference.

Installation

- When the device is mounted on wall or ceiling, the device shall be firmly fixed.
- Avoid equipment installation on vibratory surface or places subject to shock (neglect may cause equipment damage).

Power Supply

- Make sure that the power has been disconnected before you wire, install, or disassemble the device.
- The input voltage should conform to IEC60950-1 standard: SELV (Safety Extra Low Voltage) and the Limited Power Source. Refer to the appropriate documentation for detailed information. The standard power supply is 12 VDC, 24 VAC or

PoE (802.3af), please make sure your power supply matches with your camera.

- Use the power adapter provided by qualified manufacturer. Refer to the product specification for detailed power requirements. It is recommended to provide independent power adapter for each device as adapter overload may cause over-heating or a fire hazard.

Battery

- DO NOT place the battery near heating or fire source. Avoid direct sunlight.
- Improper use or replacement of the battery may result in explosion hazard. Replace with the same or equivalent type only. Dispose of used batteries according to the instructions provided by the battery manufacturer.
- For long-term storage of the battery, make sure it is fully charged every half year to ensure the battery quality. Otherwise, damage may occur.

System Security

- You acknowledge that the nature of Internet provides for inherent security risks, and our company shall not take any responsibilities for abnormal operation, privacy leakage or other damages resulting from cyber attack, hacker attack, however, our company will provide timely technical support if required.
- Please enforce the protection for the personal information and the data security as the device may be confronted with the network security problems when it is connected to the

Internet. Please contact us when the device might exist network security risks.

- Please understand that you have the responsibility to configure all the passwords and other security settings about the device, and keep your user name and password.

Maintenance

- Clean the lens with soft and dry cloth or wiping paper to avoid scratching it.
- If the product does not work properly, please contact your dealer or the nearest service center. We shall not assume any responsibility for problems caused by unauthorized repair or maintenance.
- A few device components (e.g., electrolytic capacitor) require regular replacement. The average lifespan varies, so periodic checking is recommended. Contact your dealer for details.

Using Environment

- DO NOT expose the device to extremely hot, cold, dusty, corrosive, saline-alkali, or damp environments. Make sure the running environment meets the requirement of the device. The operating temperature shall be -40 °C to 65 °C (-40 °F to 149 °F),
- DO NOT aim the lens at the sun or any other bright light.
- Keep the camera away from liquid while in use.

Emergency

- If smoke, odor, or noise arises from the device, immediately turn off the power, unplug the power cable, and contact the service center.

User Manual of Device

Scan the QR code to view the latest user manual of device on your mobile phone. Note that mobile data charges may apply if Wi-Fi is unavailable.



0505241091205

Table of Contents

1 Appearance Description	3
1.1 Type I Camera Appearance.....	3
1.2 Type II Camera Appearance.....	4
1.3 Type III Camera Appearance.....	5
1.4 Cable Description	6
1.5 Interfaces of Junction Box	9
2 Installation.....	10
2.1 Install Memory Card.....	11
2.1.1 Install Type I Camera Memory Card.....	11
2.1.2 Install Type II and Type III Camera Memory Card.....	12
2.2 Wide Range Coverage	14
2.3 Install Camera	15
2.3.1 Install Type I Camera	15
2.3.2 Install Type II and Type III Camera	18
2.4 Waterproof Measures	23
2.4.1 Install Network Cable Waterproof Jacket.....	23
2.4.2 Waterproof Other Cables	24
3 Set the Network Camera over the LAN.....	25
3.1 Wiring	25
3.2 Activate the Camera.....	26
3.2.1 Activate via Web Browser.....	26
3.2.2 Activate via SADP Software	27
3.3 Modify the IP Address	29
4 Access via Web Browser	32
Appendix	35
Frequently Asked Questions (FAQ).....	35

Device Running Error	35
Device Upgrading	35
Others	35
Common Material Emissivity Reference	37

1 Appearance Description

There are three kinds of thermal network bullet cameras: Type I bullet camera, Type II bullet camera, and Type III bullet camera. The appearance description of three cameras is shown as below.

1.1 Type I Camera Appearance

The overview of Type I thermal network bullet camera and its components are shown as below.

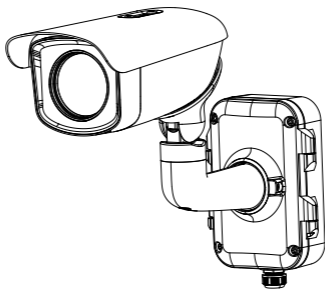

Figure 1-1 Type I Camera Overview

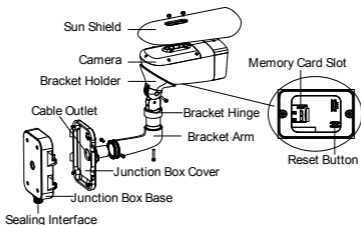

Figure 1-2 Type I Camera Components Overview

1.2 Type II Camera Appearance

The overview of Type II thermal network bullet camera is shown as below.

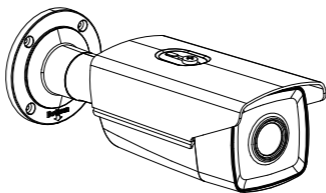

Figure 1-3 Type II Camera Overview

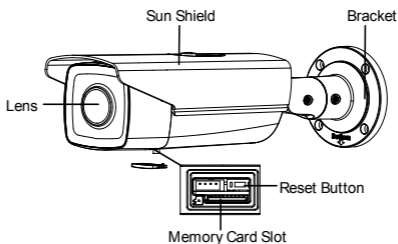

Figure 1-4 Type II Camera Components Overview

1.3 Type III Camera Appearance

The overview of Type III thermal network bullet camera is shown as below.

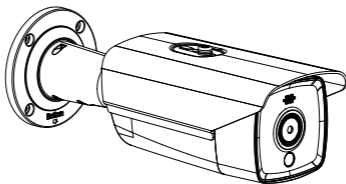

Figure 1-5 Type III Camera Overview

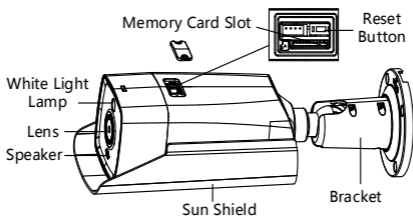

Figure 1-6 Type III Camera Components Overview

1.4 Cable Description

The bullet camera cables, including power cable, alarm cable, and audio cable are shown as figure below. The cables is different according to camera models. Refer to the actual device.

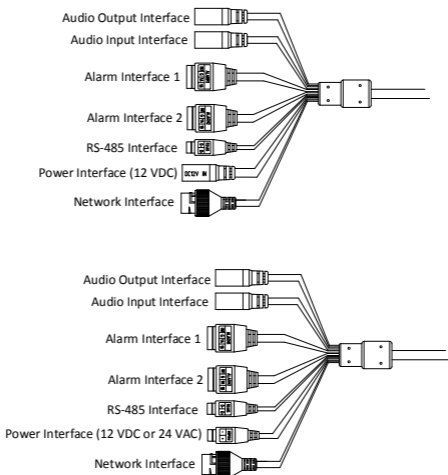

Figure 1-7 Cable Description

Table 1-1 Cable Description

Name	Description
Power Interface	For 12 VDC or 24 VAC power supply, make sure that the positive/negative terminals are connected correctly.

Name	Description
Network Interface	Connect to the LAN interface. PoE (802.3af) is supported.
Alarm Interface	Two-way alarm input and alarm output are supported. Alarm In: IN1, G/IN2, and G Alarm Out: 1A, 1B/2A, and 2B
Audio Interface	Audio In: Pickup Audio Out: Loudspeaker
RS-485 Interface	Control line.

 **NOTE**

- The cables may vary according to different models. Here we list all types of cables for reference. Take the actual product for the cables.
- Alarm cables can be classified as 2-ch alarm inputs and 2-ch alarm outputs. ALARM-IN1 and ALARM-IN2 are alarm input interfaces, and G indicates grounding interface. (1A, 1B) and (2A, 2B) indicate two alarm output interfaces.

To reset the camera to default parameters, you need to hold the Reset button and power on the camera. After powering on the camera, you must still hold the Reset button for about 10 seconds.

1.5 Interfaces of Junction Box

For certain camera models, the power cable, alarm cable, network cable, and audio cable are connected to the interfaces of the junction box. You can refer to the figure below for connection.



The junction box is different according to different models.

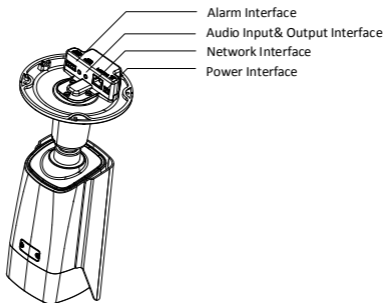

Figure 1-8 Interface Description

2 Installation

Before you start:

- Make sure the device in the package is in good condition and all the assembly parts are included.
- The standard power supply is 12 VDC or 24 VAC. Please make sure your power supply matches your camera.
- Make sure all the related devices are powered off during the installation.
- Check the specification for the installation environment.
- Make sure that the wall is strong enough to withstand eight times the weight of the camera and the bracket.

For the camera that supports IR, mind the following precautions to prevent IR reflection:

- DO NOT remove the protective film until you finish the installation. For any dust or grease on the cover, clean them with clean soft cloth and isopropyl alcohol.
- Make sure that there is no reflective surface too close to the camera lens. The IR light from the camera may reflect back into the lens causing reflection.
- DO NOT drag the camera with its waterproof cables, or the waterproof performance will be affected.



2.1 Install Memory Card



Make sure you install the memory card in the same way you disassemble the camera, so that the leak-free sealing performance will not be affected.

2.1.1 Install Type I Camera Memory Card

Steps:

1. Unscrew the memory card slot cover and remove it.

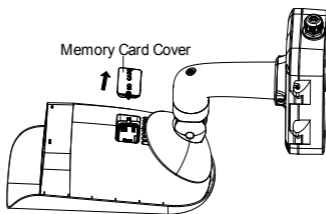

Figure 2-1 Remove Card Slot Cover (Type I Camera)

2. Insert the memory card into the memory card slot.

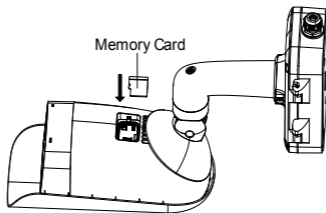

Figure 2-2 Insert Memory Card (Type I Camera)

3. Cover the memory card slot and fix the screws on the memory card slot cover.

2.1.2 Install Type II and Type III Camera Memory Card

The installation for the two types of camera is same. Here is an example of memory card installation for type II camera.

Steps:

1. Unscrew the memory card slot cover and remove it.

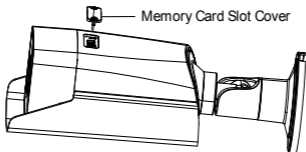

Figure 2-3 Remove Card Slot Cover (Type II Camera)

 NOTE

A rubber seal ring is on the top of the memory card slot cover. Do NOT lose the ring for the waterproof performance.

2. Insert the memory card into the memory card slot.

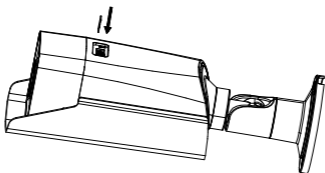

Figure 2-4 Insert Memory Card (Type II Camera)

3. Cover the memory card slot and fix the screws on the memory card slot cover.

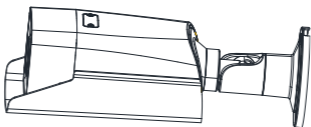

Figure 2-5 Fix Memory Card Slot Cover (Type II Camera)

2.2 Wide Range Coverage

For fixed lens camera, the auto-focus function and remote manual focus function are not supported. Select the proper installation site and proper lens focal length according to the Wide Range Coverage list below.

Table 2-1 Wide Range Coverage

Lens (focal length)	3 mm	6 mm	7 mm	10 mm	15 mm	25 mm	35 mm
Detection range (Vehicles)	280 m	559 m	631 m	902 m	1353 m	2255 m	3157 m
Detection range (Humans)	91 m	182 m	206 m	294 m	441 m	735 m	1029 m
Recognition range (Vehicles)	70 m	140 m	158 m	225 m	338 m	564 m	789 m
Recognition range (Humans)	23 m	46 m	51 m	74 m	110 m	184 m	257 m
Identification range (Vehicles)	35 m	70 m	79 m	113 m	169 m	282 m	395 m
Identification range (Humans)	11 m	23 m	26 m	37 m	55 m	92 m	129 m

 **NOTE**

This table is for reference only, and the actual detection range may vary according to different camera settings, mounting condition, monitor and so on.

2.3 Install Camera

2.3.1 Install Type I Camera

Before you start:

There are three methods of Type I camera installation: wall mounting, ceiling mounting, and stand mounting.

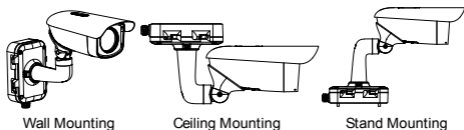

Figure 2-6 Type I Camera Installation Methods

Steps:

1. Loosen the screws on the junction box cover.
2. Draw the latches from the latch hole of the junction box and take apart the cover from the junction box.

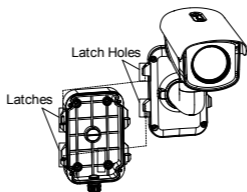

Figure 2-7 Take Apart Junction Box

3. Attach the drill template (supplied) to the place where you want to fix the camera, and then drill four screw holes (recommended depth: 40 mm) in the ceiling/wall according to the drill template.
4. Drill a cable hole according to the *A* mark of the drill template.

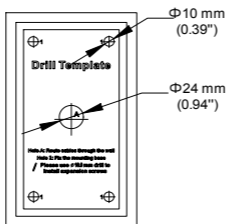

Figure 2-8 Drill Template (Type I Camera)

5. Align the hole of drill template with the screw hole of the junction box base to place the junction box onto the wall.

6. Route the screw through the sealing ring, and fix the junction box base on the wall with the screws.

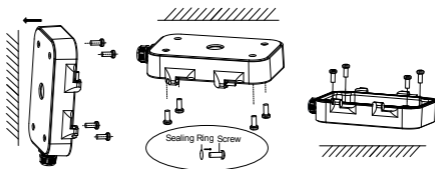

Figure 2-9 Install Junction Box Base

7. Route the cables through the cable hole.
8. Insert the latches into the latch holes to fix the bracket and camera with the junction box.

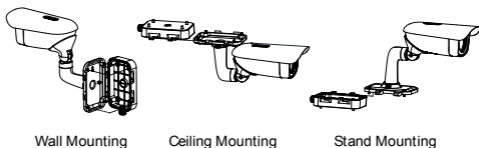

Figure 2-10 Install Junction Box Cover

9. Fix the delivered screws to secure the junction box.
10. Connect the corresponding cables to power on the camera and get the live view.
11. Adjust the camera according to the figure below.

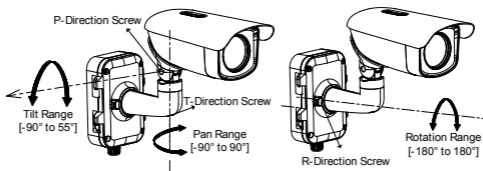

Figure 2-11 3-Axis Adjustment

2.3.2 Install Type II and Type III Camera

Type II and Type III cameras installed in the same way. Here is an example of installation for type II camera.

Steps:

1. Attach the drill template (supplied) to the place where you want to fix the camera, and then drill the screw holes in the ceiling/wall according to the drill template.
2. (Optional) If you want to route cables through the installation surface, drill a cable hole according to the drill template.

NOTE

Skip the step if you route the cable via the side opening.



Figure 2-12 Drill Template

3. (Optional) Fix the camera to the junction box.
 - 1) Attach the drill template (supplied) to the place where you want to fix the junction box, and then drill four holes in the ceiling/wall according to the drill template.
 - 2) (Optional) If you want to route cables through the installation surface, drill a cable hole according to the drill template.

 **NOTE**

Skip the step if you route the cable via the side opening

- 3) Make sure the *Top* are on the top and the *bottom* are at the bottom. Fix the junction box to the installation surface with the supplied screws.
- 4) Fix the bullet camera to the junction box with the supplied screws, as shown in Figure 2-13.

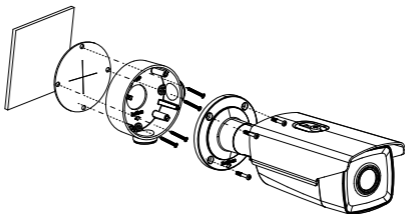

Figure 2-13 Install the Camera onto the Junction Box

4. Fix the bullet camera to the installation surface with the supplied screws, as shown in Figure 2-14.

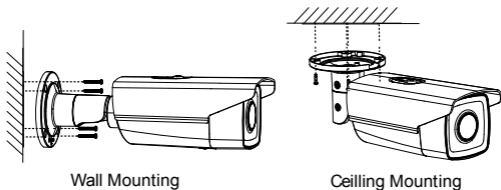

Figure 2-14 Install the Bracket onto the Wall

5. Adjust the camera to the optimal surveillance angle.
 - Type I bracket:
 - 1) Loosen the pan adjusting screw to adjust panning position [0° to 360°]. Tighten the screw.

- 2) Loosen the tilt adjusting screw to adjust the tilting position [0° to 100°]. Tighten the screw.
- 3) Loosen the rotation adjusting screw to adjust the rotation position [0° to 360°]. Tighten the screw.

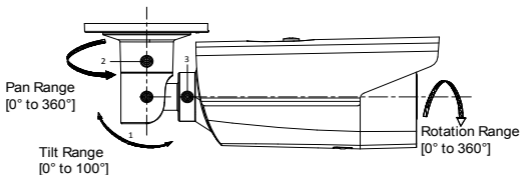

Figure 2-15 3-Axis Adjustment

- Type II bracket:
 - 1) Loosen the screw to adjust the tilting position [0° to 90°]. Tighten the screw.
 - 2) Loosen the screw to adjust the rotation position [0° to 360°]. Tighten the screw.

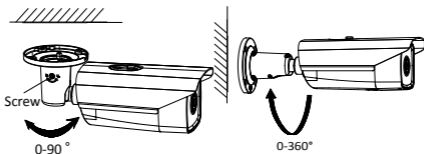

Figure 2-16 2-Axis Adjustment



NOTE

Please loosen the screws slightly until you can adjust the camera.
DO NOT remove the screws from the bracket.

2.4 Waterproof Measures

Purpose:

If the camera is installed outdoor, you should use the waterproof accessory or tapes to waterproof the cables. Otherwise the cables might get wet or a short circuit might occur.

2.4.1 Install Network Cable Waterproof Jacket

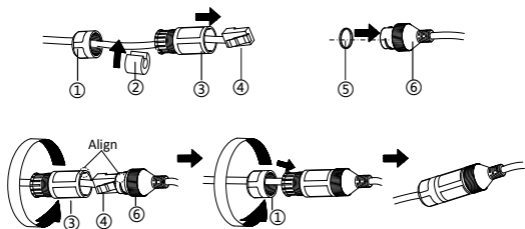

Figure 2-17 Install Waterproof Jacket

Steps:

1. Feed the network cable through ① and ③ in order.
2. Fix ② on the network cable between ① and ③.
3. Place ⑤ onto the end of ⑥, and plug the RJ45 male connector into RJ45 female connector.
4. Screw ③ to ⑥ clockwise.

5. Push ② into ③.
6. Secure ① with the ③ in clockwise direction.

2.4.2 Waterproof Other Cables

After routing and connecting the cables, use the waterproof tapes to wrap up the cables. Connected cables and spare cables both should be wrapped up as the figures below.

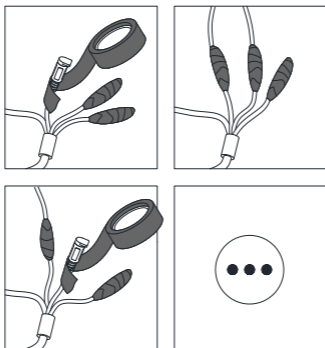

Figure 2-18 Waterproof Cables

3 Set the Network Camera over the LAN

NOTE

You shall acknowledge that the use of the product with Internet access might be under network security risks. For avoidance of any network attacks and information leakage, please strengthen your own protection. If the product does not work properly, please contact with your dealer or the nearest service center.

3.1 Wiring

Please connect to the camera to the network according to the following figures.



Figure 2-19 Connect Directly

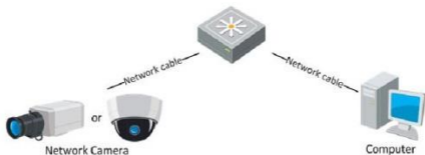

Figure 2-20 Connect via a Switch or a Router

3.2 Activate the Camera

You are required to activate the camera first by setting a strong password for it before you can use the camera.

Activation via Web Browser, Activation via SADP, and Activation via Client Software are all supported. We will take activation via SADP software and Activation via Web Browser as examples to introduce the camera activation. Please refer to the User Manual of Network Camera for Activation via Client Software.

3.2.1 Activate via Web Browser

Steps:

1. Power on the camera, and connect the camera to the network.
2. Input the IP address into the address bar of the web browser, and click Enter to enter the activation interface.



- The default IP address of the camera is 192.168.1.64.
- For the camera enables the DHCP by default, you need to activate the camera via SADP software and search the IP address.

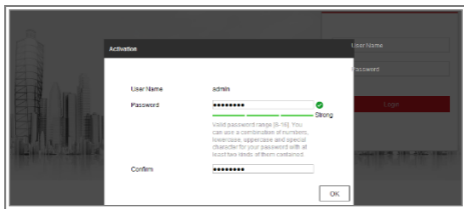

Figure 2-21 Activation Interface (Web)

3. Create a password and input the password into the password field.



We highly recommend you create a strong password of your own choosing (using a minimum of 8 characters, including upper case letters, lower case letters, numbers, and special characters) in order to increase the security of your product. And we recommend you reset your password regularly, especially in the high security system, resetting the password monthly or weekly can better protect your product.

4. Confirm the password.
5. Click **OK** to save the password and enter the live view interface.

3.2.2 Activate via SADP Software

SADP software is used for detecting the online device, activating the camera, and resetting the password.

Get the SADP software from the supplied disk or the official website, and install the SADP according to the prompts. Follow the steps to activate the camera, please refer to the User Manual of Network Camera for other two activation methods.

Steps:

1. Run the SADP software to search the online devices.
2. Check the device status from the device list, and select the inactive device.

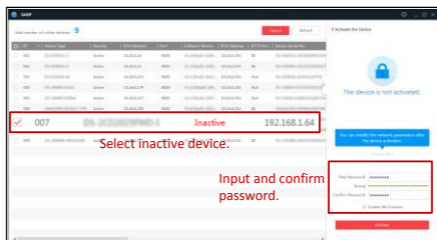

Figure 2-22 SADP Interface

NOTE

The SADP software supports activating the camera in batch. Please refer to the user manual of SADP software for details.

3. Input the password in the password field, and confirm the password.



We highly recommend you create a strong password of your own choosing (using a minimum of 8 characters, including upper case letters, lower case letters, numbers, and special characters) in order to increase the security of your product. And we recommend you reset your password regularly, especially in the high security system, resetting the password monthly or weekly can better protect your product.

4. Click **OK** to save the password.

You can check whether the activation is completed on the popup window. If activation failed, please make sure that the password meets the requirement and try again.

3.3 Modify the IP Address

Purpose:

To view and configure the camera via LAN (Local Area Network), you need to connect the network camera in the same subnet with your PC. Then, install the SADP software or client software to search and change the IP of network camera. We will take modifying the IP Address via SADP software as an example to introduce the IP address modification.

Steps:

1. Run the SADP software.
2. Select an active device.



Please refer to Chapter 3.2 to activate the camera if the camera is inactive.

3. Change the device IP address to the same subnet with your computer by either modifying the IP address manually or checking the checkbox of Enable DHCP.

Modify Network Parameters

Enable DHCP
 Enable Guarding Vision

Device Serial No.: 06-3C3D1525-020601111A000676

IP Address: 10.16.6.89

Port: 8000

Subnet Mask: 255.255.255.0

Gateway: 10.16.6.254

IPv6 Address: ::

IPv6 Gateway: ::

IPv6 Prefix Length: 0

HTTP Port: 80

Security Verification

Admin Password:

[Modify](#)

[Forgot Password](#)

Figure 2-23 Modify the IP Address

4. Input the password to activate your IP address modification.

The batch IP address modification is supported by the SADP. Please refer to the User Manual of SADP for details.

4 Access via Web Browser

System Requirement:

Operating System: Microsoft Windows XP SP1 and above version

CPU: 2.0 GHz or higher

RAM: 1G or higher

Display: 1024×768 resolution or higher

Web Browser: Internet Explorer 8.0 and above version, Apple Safari 5.0.2 and above version, Mozilla Firefox 5.0 and above version and Google Chrome 18 and above version

Steps:

1. Open the web browser.
2. In the browser address bar, input the IP address of the network camera, and press the **Enter** key to enter the login interface.



NOTE

- The default IP address is 192.168.1.64.
 - If the camera is not activated, please activate the camera first according to Chapter 3.2.
3. Input the user name and password.

The admin user should configure the device accounts and user/operator permissions properly. Delete the unnecessary accounts and user/operator permissions.



NOTE

The device IP address gets locked if the admin user performs 7 failed password attempts (5 attempts for the user/operator).

4. Click **Login**.



Figure 2-24 Login Interface

5. Install the plug-in before viewing the live video and managing the camera. Please follow the installation prompts to install the plug-in.



NOTE

You may have to close the web browser to finish the installation of the plug-in.

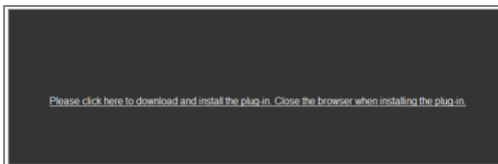

Figure 2-25 Download Plug-in

6. Reopen the web browser after the installation of the plug-in and repeat steps 2-4 to login.



NOTE

For detailed instructions of further configuration, please refer to the user manual of network camera.

Appendix

Frequently Asked Questions (FAQ)

Device Running Error

Question:

The device fails to start up or reboots repeatedly.

Answer:

- Examine the power supply of the device and see whether it meets the requirements.
- Select the power supply as close as possible.
- Examine the power cord and see whether it meets the requirements.

Device Upgrading

Question:

Device fails to upgrade.

Answer:

- Examine if the device upgrading fails because of the poor network.
- Examine if the upgrading program matches with the device type.

Others

Question:

The device live view is vague.

Answer:

- Examine if you removed the protective film.
- Examine if the lens is dirty or not.
- Examine if any obstruction is nearby, e.g. spider web.

Question:

Live view fails with good network connection.

Answer:

- Examine if the IE plug-in is well installed. Change the Website Blocker settings if necessary.
- For cross-domain routing, enable the UPnP of device, or set manual mapping to port No. 80, 8000, or 554.
- Examine if the live view channel amount exceeds the upper limit.
- Examine the network bandwidth.

Question:

Focus fails when you test outdoor device in indoor situation.

Answer:

- Restore the device to default settings.
- Adjust the **Min. Focusing Distance** in **Configuration > Image> Display Settings > Focus**.

Common Material Emissivity Reference

Material	Emissivity
Human Skin	0.98
PCB	0.91
Cement Concrete	0.95
Ceramics	0.92
Rubber	0.95
Paint	0.93
Wood	0.85
Asphalt	0.96
Brick	0.95
Sand	0.90
Soil	0.92
Cotton	0.98
Cardboard	0.90
White Paper	0.90
Water	0.96

